

2016



LP GAS &  
ANHYDROUS  
AMMONIA

EQUIPMENT MANUFACTURER



**MARSHALLEXCELSIOR**  
innovation *made simple*

# QUICK REFERENCE GUIDE

SECTION	PAGE
Introduction.....	1
Mission Statement.....	2
New Product Pages.....	3-55
<b>Excelsior Flo Regulators.....</b>	<b>6-37</b>
<b>Truck &amp; Plant Equipment.....</b>	<b>38-109</b>
<b>Accu-Max™ Float Gauges.....</b>	<b>110-116</b>
<b>Pressure Relief Valves &amp; Manifolds.....</b>	<b>117-130</b>
<b>DOT/ASME Container Valves.....</b>	<b>131-140</b>
<b>Dispensing Valves &amp; Adapters.....</b>	<b>142-146</b>
<b>Pigtails, Hogtails &amp; Hose Assemblies.....</b>	<b>147-151</b>
<b>Fittings &amp; Accessories.....</b>	<b>152-171</b>
<b>Replacement Parts &amp; Repair Kits.....</b>	<b>172-178</b>
Index.....	179-182
Warranty.....	183-184

## ABOUT THIS CATALOG

This catalog is designed to provide a comprehensive overview of Marshall Excelsior's products. Due to the continuous development and additions to our product lines, this catalog may not include all products Marshall Excelsior offers. To see any new products that have been developed after this publication visit [www.marshallexcelsior.com](http://www.marshallexcelsior.com).

Pictures in this catalog will resemble the product shown. However, due to continuous improvements and changes in regulations, we do not guarantee that the picture in this catalog will be the exact replica of the product purchased. Any pictures shown in a group of products will resemble the other products being offered in the same group unless otherwise stated.

Marshall Excelsior is a manufacturer of LP-Gas and anhydrous ammonia (NH<sub>3</sub>) equipment. Unless otherwise stated, all products are designed and manufactured to be used only with LP-Gas or NH<sub>3</sub> and can withstand temperatures from -40° to +165° Fahrenheit. If there is a product that you would like to use for a different application contact your authorized Marshall Excelsior Distributor or Marshall Excelsior before installing the product.

This catalog is for general information only and should not be viewed as an all inclusive catalog of important technical information, regulations, warnings or installation instructions. Contact your authorized Marshall Excelsior Distributor or Marshall Excelsior for more information.



For over 40 years Marshall Excelsior Company has been a progressive manufacturer of top quality and competitively priced LPG & NH<sub>3</sub> equipment that is leading the industry in innovation and low emission products. We offer a full range of products that support the LPG & NH<sub>3</sub> Bulk Plant, Transport, Delivery/Dispensing, and Domestic applications. As our product line continues to grow, we are striving to improve product functionality while taking the industry standards to a higher level of quality and performance without adding excessive cost. While following along this path, our engineering staff exercises a heavy reliance on the input from our customers throughout any new product design phase. It has been through these theories and approaches that we have been able to carve out our niche in an industry where safety and performance must work hand-in-hand. Our goal is to create the safest equipment solutions for everyday operations while allowing the largest amount of product to be transferred, dispensed, or otherwise used, resulting in an overall savings to the customer.

In addition to our company philosophy for new product development, you will find our approach to daily operations equally unique. In a time where materials, fuels, and other manufacturing costs are on the rise, we have not only remained competitive, but one of the industry leaders in on-time deliveries and short lead-times. The reason is simple; we not only manufacture our products effectively, but carry one of the most extensive on-hand inventories available in the industry. This allows our distributors to react quickly without having an excessive amount of stock on hand.

Put this together with our proactive, responsive sales and customer service staff and you have a winning combination.

As one of the industry leaders in responsiveness it is essential for our organization to be able to react in a rapid fashion, hence our fully integrated manufacturing and purchasing process. Our capabilities in manufacturing range from high volume to custom made product. Both of which are supported by our wide variety of manufacturing equipment, highly skilled personnel, and dedicated purchasing staff. Combine these attributes with our top notch ISO9001 quality system and you have a combination that easily rivals that of our nearest competition.

Over the course of time Marshall Excelsior Company has become a name that our customers can rely on not only for high quality products and services, but as a partner in building their business. Together, with our commitment to the industries served and our eagerness to improve and expand our product-line our customers routinely find the opportunity to promote our organization. It is through this personal touch that our family owned and operated business has become the organization that it is today. We are confident that as our company continues to develop and mature in our industries, Marshall Excelsior Company will become a brand of choice.



# 2016 New Products

**TURBO-FLO LE  
Dry Break  
Transfer System**



ME808-16  
Pg. 39

*High Flow* Socket Weld  
Back Check Valve



ME870SW-16  
Pg. 65

ME994S-2F-16  
ME994S-3F-24  
Pg. 77



2"-300lb x 2"-8 Bolt &  
3"-300lb x 3"-8 Bolt  
Companion Flange  
Internal Valves

2" Double Flange  
Globe Valve



ME823-16  
Pg. 44

Universal  
Flange Kits



MEP840 / MEP841 Series  
Pg. 52

## Excelsa-Flange Series

2" Double Flange  
Angle Valve



ME813-16  
Pg. 44

2" Flange x NPT  
Globe Valve



ME819-16  
Pg. 44

Valve  
Installation Tool



MEP873  
Pg. 62

*High Flow*  
Socket Weld  
Bodies



MEP995S-24/16  
MEP996S-16  
Pg. 51

Excess Flow Valves



ME883S-16 Series  
Pg. 62

*High Flow*  
Back Check  
Valves



ME873S &  
ME873SBN Series  
Pg. 64

# Celebrating 40 MEC

1976 YEARS 2016

*Innovation Made Simple*



**DOT  
Withdrawal  
Valves**

**100lb.  
Liquid  
Service**

MES-PVE3250CLM Series  
Pg. 137



**100 lb.  
Vapor  
Service**  
MES-PVE3250CLG Series  
Pg. 136

**1" Full Internal  
Pressure Relief  
Valve**



MEVS-UVE445A Series  
Pg. 125

**Semi-Internal  
Pressure Relief  
Valves**  
3/4", 1" and  
1-1/4" MNPT



MEVS-UVE443A  
Pg. 128



MEVS-UVE433A  
Pg. 128



MEVS-UVE453A  
Pg. 128

**3/4" & 1-1/4"  
External Pressure  
Relief Valves**



MEVS-PVE431/250  
Pg. 123

**Underground Tank  
Cluster  
Manifold**



MES-PVE2098AT  
Pg. 141

**Mini  
Quad-Port Manifold**



ME903S-16B Series  
Pg. 121-122

**Multi-Service  
Vapor Valves**



**200 LB.**

MES-PVE2030BC  
Series  
Pg. 138



**420 LB.**

MES-PVE2035AT Series  
Pg. 139

# 2016 New Products

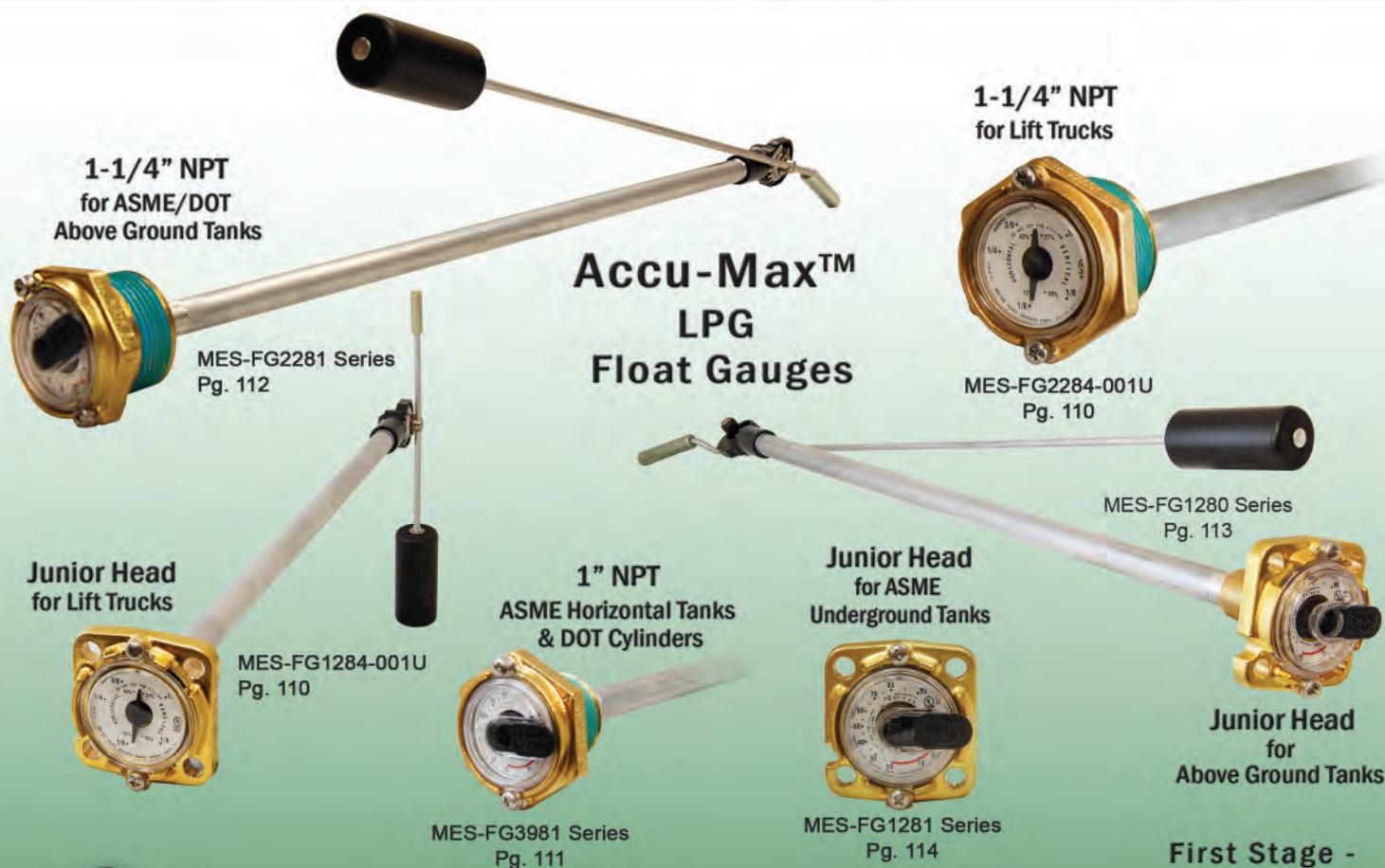

## Excela-flo Regulators



# FEATURES AND BENEFITS

1. Dust cap with hex and finger grips
2. Full round flange for evenly distributed compression
3. Locating tabs
4. Premium powder coat inside and out
5. Large wrench flats
6. Ribbed vent screen for easy removal
7. Fabric reinforced molded diaphragm
  - a. Interlocking diaphragm and diaphragm plate.
  - b. Rounded edges on diaphragm plate
  - c. Sealing and locating bead on diaphragm
8. Travel stops - to prevent damage to diaphragm
9. Stainless steel lever design
10. Pre-installed mounting screws for installation convenience
11. Large aluminum orifice
12. Large drip vent
13. Adjustment direction indicator
14. Plugged high pressure gauge port on all integral two stage regulators
15. 3 part tear off data label for installation records
16. (FKM) Fluorocarbon seats for maximum protection against contamination

\* Some features - Patent Pending

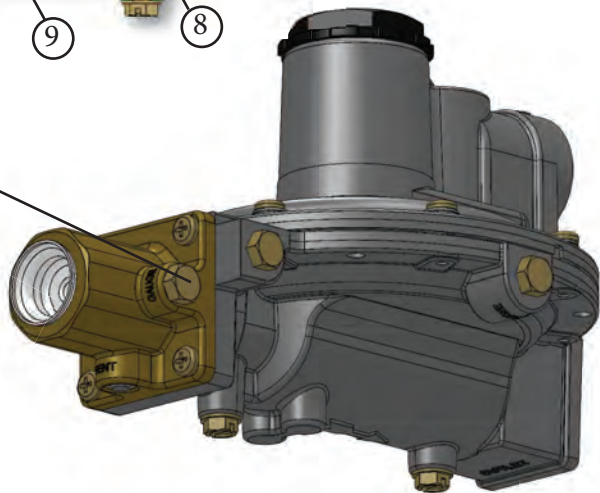
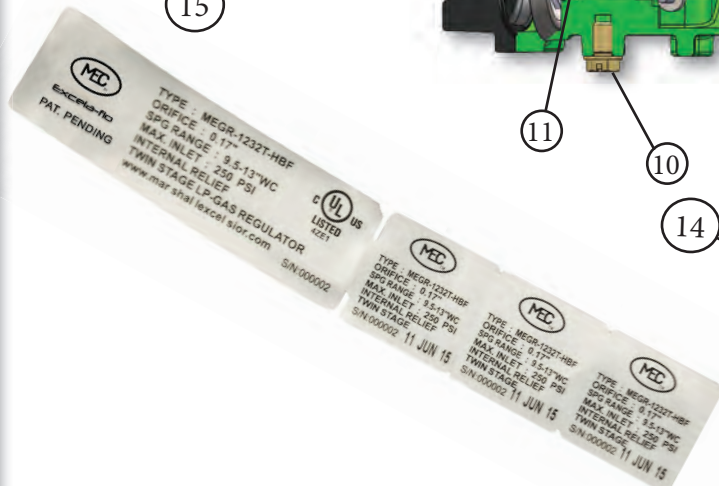
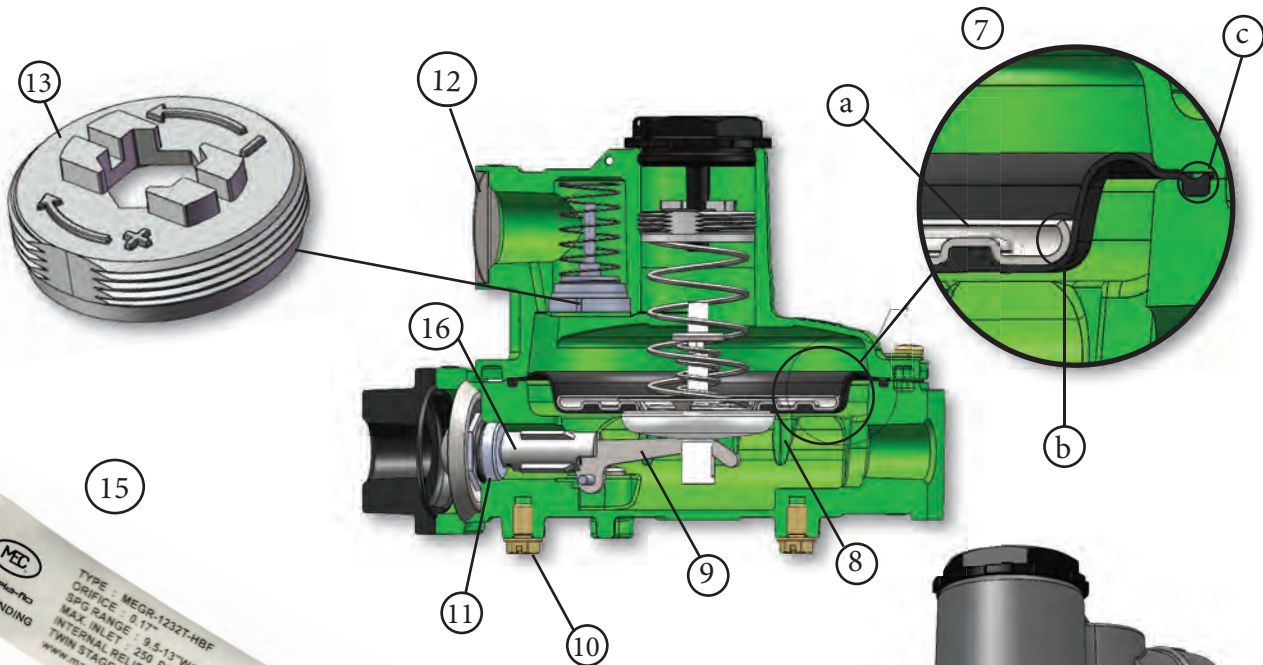
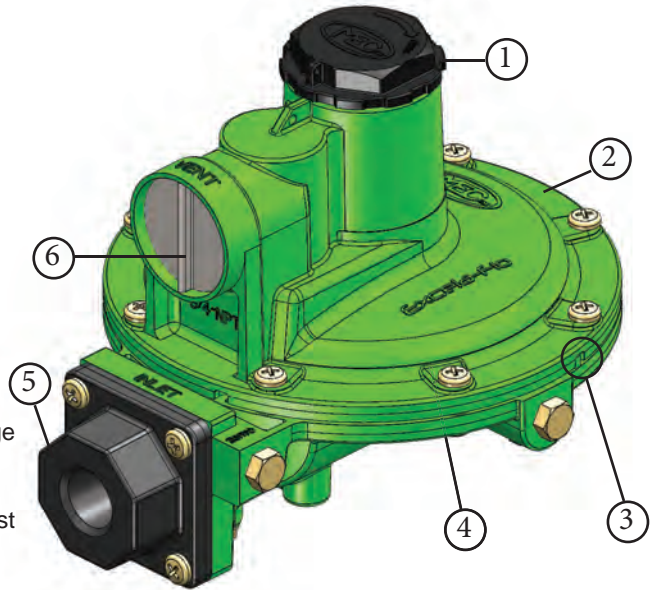

# INSTALLATION AND OPERATING INSTRUCTIONS

## MEGR-1100, 1200 AND 1600 SERIES

### !WARNING!

Failure to follow these instructions or to properly install and maintain this equipment could result in an explosion and/or fire causing property damage and personal injury or death.

Marshall Excelsior equipment must be installed, operated and maintained in accordance with federal, state and local codes and MEC instructions. The installation in most states must also comply with NFPA 54 and NFPA 58 standards.

Only personnel trained in the proper procedures, codes, standards and regulations of the LP-Gas industry shall install and service this equipment.

#### Things to tell the gas customer:

1. Show the customer the vent, vent assembly or vent line. Stress that this opening must remain unobstructed at all times. Tell the customer to check the vent opening after a freezing rain, sleet storm, or snow to make sure ice has not formed in the vent.
2. Show the customer the shutoff valve on the container. The customer should close this valve immediately if gas is smelled, appliance pilot lights fail to stay on or appear higher than usual or any other abnormal situation occurs.
3. Tell the customer to call your company to service the regulator if the regulator vents gas or a leak develops in the system. **Only a qualified gas service person shall install or service the regulators.**

#### Scope of the Manual

This instruction manual covers installation and maintenance for the first stage, second stage, and integral two-stage regulators used on LP-Gas vapor service applications. **They are not to be used on liquid service.**

#### Description

**25 Year Recommended Replacement Life:** The MEC Regulator Series is designed using rugged time-proven design concepts and constructed of corrosion resistant materials, both internally and externally. With proper installation and periodic inspection and maintenance, they will meet a 25 Year Recommended Replacement Life.

**Screened Drip-Lip:** Screened Drip-Lip is oriented either over the inlet, outlet, or at 90° depending on the configuration.

**Pressure Tap Size Restrictions:** 1/8" NPT / #54 (0.055") orifice on all pressure points.

**Temperature Capabilities:** -40°F to 160°F (-40°C to 71°C)

Contact the factory if the regulator is to be used on any service other than LP-Gas. The following information is located on the spring case: The Part Number, orifice size, spring range and date code.

#### 2nd Stage Low Pressure Regulator - UL Listed:



MEGR-1222 MEGR-1252 MEGR-1622 MEGR-1642 MEGR-1652  
FIGURE 1: SECOND STAGE REGULATOR

The second stage regulator is designed to reduce the outlet pressure from a first-stage regulator (usually 10 psig (0,69 bar)) to an outlet pressure of 11 -inches water column (27 bar).

The combination of a high capacity relief valve and large vent provide overpressure protection which exceeds UL standards and is capable of limiting the downstream pressure to 2 psig (0,14 bar) even in a double failure situation when used with a first-stage regulator.

#### Integral Two-Stage Regulator - UL Listed:



MEGR-1232 MEGR-1632  
FIGURE 2: INTEGRAL TWO-STAGE REGULATOR

The integral two-stage regulator contains a non-adjustable first stage regulator on the inlet of the second stage portion of the regulator. It is designed to reduce the tank pressure to an outlet pressure of 11 inches water column. The second stage portion has a high capacity internal relief valve construction. The first stage does not have an internal relief valve.

#### First Stage Regulator - UL Listed:



MEGR-1222H MEGR-1622H  
FIGURE 3: FIRST STAGE REGULATOR

The first stage regulators are designed for high pressure (pounds per square inch) vapor service. These regulators have high capacity internal relief valves. The outlet pressure setting is factory set at a nominal 10 psig (0,69 bar).

#### 2 PSI Service Regulator - UL Listed:

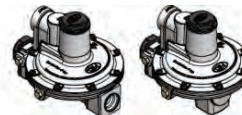

MEGR-1622E MEGR-1652E  
FIGURE 4: 2 PSI SERVICE REGULATOR

The 2 PSI service regulator is designed to reduce the outlet pressure from a first-stage regulator (usually 10 psig (0,69 bar)) to a nominal outlet pressure of 2 psig (0,14 bar).

The combination of high capacity relief valve and large vent provide overpressure protection which exceeds UL standards and is capable of limiting the downstream pressure in a double failure situation when used with a first-stage regulator.

#### 2-PSI Integral Two Stage Regulator - UL Listed:



MEGR-1232E MEGR-1632E  
FIGURE 5: 2 PSI INTEGRAL TWO-STAGE REGULATOR

The integral two-stage 2 PSI regulator contains a non-adjustable first stage regulator on the inlet of the second stage portion of the regulator. It is designed to reduce the tank pressure to a nominal outlet pressure of 2 psig (0,14 bar). The second stage portion has a high capacity internal relief valve construction. The first stage does not have an internal relief valve.

#### Installation

### !WARNING!

All vents should be kept open to permit free flow of air in and out of the regulator. Protect vent openings against the entrance of rain, snow, ice formation, paint, mud, insects or any other foreign material that could plug the vent or vent line.

LP-Gas may discharge to the atmosphere through the vent. An obstructed vent which limits air or gas flow can cause abnormally high pressure that could result in personal injury or property damage.



# INSTALLATION AND OPERATING INSTRUCTIONS

## MEGR-1100, 1200 AND 1600 SERIES

### Installation (Continued)

#### !WARNING!

The first stage and integral two-stage regulators are not suitable for indoor installations. Never use them on low pressure (inches of water column) service because personal injury or property damage could occur.

#### Before installation:

- Check for damage, which may have occurred in shipment.
- Check for and remove any dirt or foreign material that may have accumulated in the regulator body.
- Replace old pigtails. Blow out any debris, dirt or copper sulfate in the copper tubing and the pipeline.
- Apply pipe compound to the male threads of the pipe before installing the regulator.
- Make sure gas flow through the regulator is in the same direction as the arrow on the body. "Inlet" and "Outlet" connections are clearly marked.

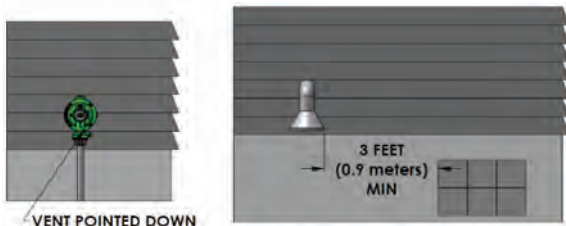

Figure 2: Regulator with Vent Pointed Down

#### Installation Location, see Figure 2:

- The installed regulator should be adequately protected from vehicular traffic and damage from other external sources.
- **Install the regulator with the vent pointed vertically down.** If the vent cannot be installed in a vertically down position, the regulator must be installed under a separate protective cover. Installing the regulator with the vent down allows condensation to drain, minimizes the entry of water or other debris from entering the vent, and minimizes vent blockage from freezing precipitation.
- **Do not install the regulator in a location where there can be excessive water accumulation or ice formation,** such as directly beneath a down spout, gutter or roof line of building. Even a protective hood may not provide adequate protection in these instances.
- Install the regulator so that any gas discharge through the vent or vent assembly is over 3-feet (0.9 meters) horizontally from any building opening below the level of discharge and not less than 5-feet in any direction away from any source of ignition, openings into direct vent appliances, or mechanical ventilation air intakes.
- Install the regulator high enough above ground level - at least 24-inches (60 cm) - so that rain splatter cannot freeze in the vent.
- Some installations, such as in areas with heavy snowfall, may require a hood or enclosure to protect the regulator from snow load and vent freeze over.

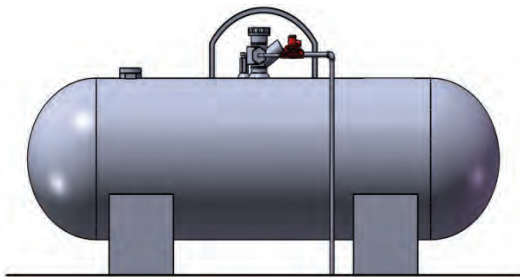

Figure 3: Tank Installation



#### Horizontally Installed Regulators, see Figure 3:

Horizontally mounted regulators, such as found in single cylinder installations and ASME tanks, must be installed beneath a protective cover or under the ASME tank dome. If possible, slope or turn the vent down sufficiently to allow any condensation to drain out of the spring case. Be careful that the slot in the tank dome or protective cover for the regulator's outlet piping does not expose the vent to the elements. The first stage vent on the integral two-stage regulator should be pointed down.

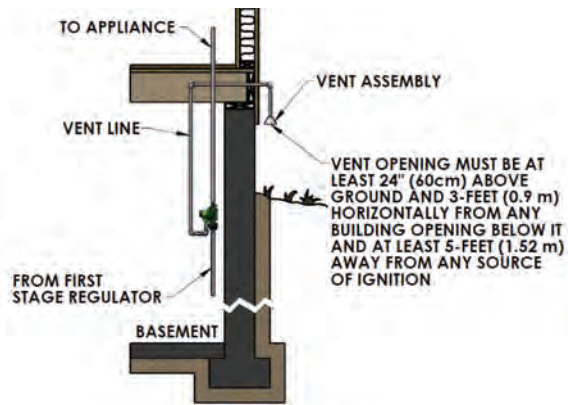

Figure 4: Basement Installation

#### Indoor Installations, see Figure 4:

The first stage and integral regulators are not recommended for indoor installations. The second stage regulator may be installed indoors as follows.

By code, regulators installed indoors have limited inlet pressure, and they require a vent line to the outside of the building. A vent assembly, such as MEC ME960 or at least 3/4" NPT pipe, Gray PVC Schedule 40 Rigid Non-Metallic Electrical Conduit for above Ground Service, per UL 651, should be used. The same installation precautions, previously discussed throughout this manual for the regulator vent, apply to the end of the vent tube assembly. Vent lines must not restrict the gas flow from the regulator's internal relief valve. To install the vent line, remove the vent screen and apply a good grade of pipe compound to the male threads of the line. Vent lines should be as straight as possible with a minimum number of bends.

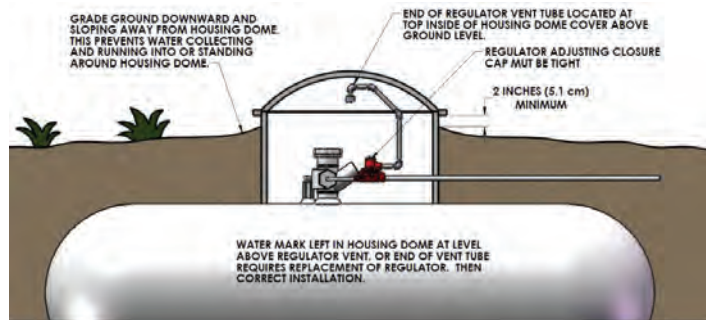

Figure 5: Underground Installation

#### Underground Installations, see Figure 5:

#### !WARNING!

The integral two-stage regulators require 2 vent lines, one for the first stage vent (1/4" OD copper tube inverted flare connection: 7/16-24 UN thread) and the other for the second stage vent (3/8" NPT) of the regulator. Failure to use 2 separate vent tubes can result in early regulator failure and / or overpressuring the second stage that could result in fire or personal injury.

# INSTALLATION AND OPERATING INSTRUCTIONS

## MEGR-1100, 1200 AND 1600 SERIES

A regulator installed in the dome of an underground container requires a vent line to prevent water from entering the regulator spring case. Remove the vent screen(s) and install a vent line(s). The vent line must be run from the regulator vent(s) to above the maximum water table. The vent line opening(s) must terminate at the extreme top inside of the dome cover. Make sure the regulator's closing cap is on tightly, and maintain drainage away from the dome at all times.

### Adjustment

Each regulator is factory set. If it becomes necessary to increase the outlet pressure, remove the closing cap and turn the adjustment screw clockwise. Turn the adjusting screw counterclockwise to decrease the outlet pressure.

The inlet and outlet pressure tap plugs may be removed using a 7/16" wrench. The pressure tap is restricted with a #54 orifice, so the plug can be removed with pressure in the regulator. Install a pressure gauge to determine the regulator's inlet pressure and outlet setting during adjustment. Actual pressure at the second stage regulator may be less due to line loss. After setting, add thread sealant to the pipe plug and reinstall it. Replace the closing cap. Check the plug for leakage.

### Overpressure Protection

#### !WARNING!

**Some type of overpressure protection is needed if actual inlet pressure can exceed the inlet pressure rating. Overpressuring any portion of this equipment above the limits shown in the Specifications may cause damage to regulator parts, leaks in the regulator, or personal injury due to bursting of pressure-containing parts or explosion of accumulated gas.**

**If any portion of the regulator is exposed to an overpressure condition that exceeds the limits in the Specifications, it must be inspected for damage that may have occurred.**

**Large volumes of gas may discharge though the regulator vent during internal relief valve operation, which can, if not controlled, result in fire or explosion from accumulated gas.**

The first stage, integral two-stage, and second stage series regulator, **except for the first stage of the integral two-stage**, contain internal relief valves. The internal relief valve in all units will give overpressure protection against excessive build-up resulting from seat leakage due to worn parts, chips or foreign material on the orifice. The amount of internal relief protection provided varies with the regulator type and the cause for the overpressure relief valve operation. When the internal relief valve opens, gas escapes to the atmosphere through the regulator's vent.

Some type of additional external overpressure protection must be provided if the outlet pressure in an overpressure condition exceeds the inlet pressure rating of the gas system or downstream equipment. Common methods of external overpressure protection include relief valves, monitoring regulators, shutoff devices, and series regulation.

### Maintenance

#### !WARNING!

**To avoid personal injury or equipment damage, do not attempt any maintenance or disassembly without first isolating the regulator from system pressure and relieving all internal pressure.**

**Regulators that have been disassembled for repair must be tested for proper operation before being returned to service. Only parts manufactured by MEC should be used for repairing MEC regulators. Relight pilot lights according to normal startup procedures found in the appliance manufacturers' instructions.**

**Due to normal wear or damage that may occur from external sources, these regulators must be inspected and maintained periodically. The frequency of inspection and replacement of the regulators depends upon the severity of service conditions or the requirements of local, state and federal regulations. Even under ideal conditions, these regulators should be replaced after**

**25 years from date of manufacture or sooner should inspection reveal the need.**

**Visually inspect the regulator each time a gas delivery is made for:**

- Improper installation; such as vent not pointed vertically down or under a cover, no vent line on underground systems
- Plugged or frozen vent
- Wrong regulator or no regulator in the system
- External corrosion
- Flooded Regulator; water in spring case, regulator submersed on underground tanks
- Regulator age
- Any other condition that could cause the uncontrolled escape of gas

**Failure to do the above could result in personal injury or property damage.**

### Vent Opening

Make sure the regulator vent, vent assembly, or vent line does not become plugged by mud, insects, ice, snow, paint, etc. The vent screen aids in keeping the vent from becoming plugged; the screen should be clean and properly installed.

### Water inside Regulators from Floods, Weather or Water Table on Underground Systems

Replace any regulator that has been flooded or has been submersed below the water, has water in the spring case or shows evidence of external or internal corrosion. Checking for internal corrosion on the first stage and integral two-stage of the second stage portion, can be done by removing the closing cap and with the aid of a flashlight observing the condition of the relief valve spring, main spring and internal spring barrel area. A more detailed examination will require shutting down the gas system and the complete removal of the adjusting screw. The second stage regulator must be completely disassembled by a qualified person to look for internal corrosion. Closely examine regulators installed with their vent horizontal for signs of corrosion. Correct any improper installations.

### Regulator Replacement

Older regulators are more likely to fail catastrophically because of worn or corroded parts. Replace all regulators over 25 years of age. Other service or environmental conditions may dictate replacement of the regulator before the end of its 25 year service life.

Regulators that are installed on underground systems and in areas that are subject to sea salt (coastal) atmospheres should be inspected annually for external and internal corrosion and may require replacement sooner.

### Regulator Repair

**Only personnel trained in the proper procedures, codes, standards and regulations of the LP-Gas industry shall install and service this equipment.**

Regulators that have been disassembled for repair must be tested for proper operation before being returned to service. Only parts manufactured by MEC should be used to repair MEC regulators. Be sure to give the complete Part Number of the regulator when corresponding with the factory.

The part number, orifice size, and spring range are on a label attached to the spring barrel. The date of manufacture is stamped on the regulator. Always provide this information in any correspondence with your MEC Distributor regarding replacement parts or technical assistance. **If construction changes are made in the field, be sure that the regulator marking is also changed to reflect the most recent construction.**



SPECIFICATIONS - MEGR-1100 AND 1200 SERIES

TABLE 1: 1100 AND 1200 SERIES SPECIFICATIONS

REGULATOR APPLICATION	PART NUMBER	CAPACITY BTU/HR PROPANE (1)	INLET CONNECTION	OUTLET CONNECTION	3/8-INCH FNPT SCREENED VENT STANDARD LOCATION	NOMINAL RELIEF VALVE START-TO-DISCHARGE	MAX OUTLET PRESSURE WITH DISC REMOVED		ORIFICE SIZE	MAX ALLOWABLE INLET PRESSURE	MAX EMERGENCY INLET PRESSURE	OUTLET PRESSURE STANDARD SETPOINT	OUTLET PRESSURE SPRING RANGE	REGULATOR COLOR
							INLET PRESSURE	MAX OUTLET PRESSURE						
Second Stage	MEGR-1222-BAF	500,000	1/2-in FNPT	1/2-in FNPT	Over Inlet	1 psi (0.069 bar)	30 psig (2.07 bar)	0.14-in (3,6 mm)	10 psig (0,69 bar)	75 psi (5,2 bar)	11-in w.c. (27 mbar)	9.5 to 13- in w.c. (24 to 32 mbar)	Green	
	MEGR-1252-BAF													
	MEGR-1252-CFF	650,000	3/4-in FNPT											
Integral Two-Stage	MEGR-1232-8BF	450,000	1/4-in FNPT	1/2-in FNPT	First Stage (2): Down Second Stage: Over Outlet	1 psi (0.069 bar)	250 psig (17,2 bar)	0.17-in (4,3 mm)	250 psig (17,2 bar)	250 psig (17,2 bar)	First Stage: approx. 10 psi (0,69 bar) Second Stage: 9.5 to 13-in w.c. (24 to 32 mbar)	First Stage: non-adjustable Second Stage: 9.5 to 13-in w.c. (24 to 32 mbar)	Gray	
	MEGR-1232-HBF													
	MEGR-1232T-HBF													
	MEGR-1232-8BFXA													
	MEGR-1232-HBFXA													
	MEGR-1232T-HBFXA													
2 PSI (0.14 bar) SERVICE	MEGR-1232E-8BH	500,000	1/4-in FNPT	1/2-in FNPT	First Stage (2): Down Second Stage: Over Outlet	4 psi (0,28 bar)	50 psig (3,4 bar)	7/32-in (5,6 mm)	10 psig (0,69 bar)	15 psig (1,03 bar)	2 psig (0,14 bar)	1 to 2,2 psi (0,069 to 0,15 bar)	WHITE	
	MEGR-1232E-8BHXA													
	MEGR-1232E-HBH													
	MEGR-1232E-HBHXA													
	MEGR-1232H-AAJ													
	MEGR-1232H-AAJXB													
First Stage	MEGR-1222H-BGF	1,000,000	FPOL	FPOL	Over Outlet	1.6 psi (1,10 bar)	250 psig (17,2 bar)	0.15-in (3,8mm)	250 psig (17,2 bar)	250 psig (17,2 bar)	10 psi (0,69 bar)	8 to 12 psi (0,55 to 0,83 bar)	Red	
	MEGR-1222HT-BGF													
	MEGR-1222H-BGFXB													
	MEGR-1222HT-BGFXB													

(1): Capacities Based on:

Second Stage: 10 psig (0.69 bar) inlet pressure with 2-inches w.c. (5 mbar) droop.

Integral Second Stage: 30 psig (2.07 bar) inlet pressure and 2-inches w.c. (5 mbar) droop.

First Stage: 30 psig (2.07 bar) inlet pressure and 20% droop.

(2): Integral First-Stage Vent size: 7/16-24 UN thread for 1/4-inch OD copper tube inverted flare fitting.



# SPECIFICATIONS - MEGR-1600 SERIES

TABLE 2: 1600 SERIES SPECIFICATIONS

REGULATOR APPLICATION	PART NUMBER	CAPACITY BTU/HR. PROPANE (L)	INLET CONNECTION	OUTLET CONNECTION	3/4-INCH FNPT SCREENED VENT STANDARD LOCATION	NOMINAL RELIEF VALVE START-TO-DISCHARGE	MAX OUTLET PRESSURE WITH DISC REMOVED		ORIFICE SIZE	MAX ALLOWABLE INLET PRESSURE	MAX EMERGENCY INLET PRESSURE	OUTLET PRESSURE STANDARD SETPOINT	OUTLET PRESSURE SPRING RANGE	REGULATOR COLOR
							INLET PRESSURE	MAX OUTLET PRESSURE						
Second Stage	MEGR-1622-BCF	710,000	1/2-in FNPT	1/2-in FNPT	Over Inlet	1 psi (0.069 bar)	50 psig (3.4 bar)	2 psig (0.14 bar)	7/32-in (5.6 mm)	10 psig (0.69 bar)	15 psig (1.03 bar)	11-in w.c. (27 mbar)	9 to 13-in w.c. (22 to 32 mbar)	Green
	MEGR-1652-CFF	1,000,000	1/2-in FNPT	3/4-in FNPT Back Mount										
	MEGR-1652-DF	1,000,000	3/4-in FNPT	3/4-in FNPT										
	MEGR-1632-CFF	1,300,000	1/2-in FNPT	1/2-in FNPT										
	MEGR-1622-DF	900,000	3/4-in FNPT	3/4-in FNPT Side Mount										
	MEGR-1632-BCF	700,000	1/4-in FNPT	1/4-in FNPT	First Stage (2): Down Second Stage: Over Outlet									
	MEGR-1632-HCF	700,000	FPOL	2X FPOL										
	MEGR-1632-HCF	950,000	1/4-in FNPT	1/4-in FNPT										
	MEGR-1632-CFF	900,000	FPOL	2X FPOL										
	MEGR-1632-JFF	900,000	2X FPOL	2X FPOL										
Integral Two-Stage	MEGR-1632-BCFXA	700,000	1/4-in FNPT	1/4-in FNPT	First Stage (2): Down Second Stage: Opposite Gauge Taps	1 psi (0.069 bar)	250 psig (17.2 bar)	2 psig (0.14 bar)	7/32-in (5.6 mm)	250 psig (17.2 bar)	250 psig (17.2 bar)	10 psi (0.69 bar)	First Stage: approx. non-adjustable Second Stage: 9 to 13-in w.c. (22 to 32 mbar)	Gray
	MEGR-1632-CFFXA	950,000	1/4-in FNPT	1/4-in FNPT										
	MEGR-1632-JFFXA	900,000	FPOL	2X FPOL										
	MEGR-1632-CFFXA	950,000	1/4-in FNPT	1/4-in FNPT										
	MEGR-1632-JFFXA	900,000	2X FPOL	2X FPOL										
	MEGR-1622E-BCH	1,100,000	1/2-in FNPT	1/2-in FNPT	Over Inlet									
	MEGR-1622E-DCH	1,400,000	1/2-in FNPT	3/4-in FNPT	Over Inlet									
	MEGR-1632E-BCH	900,000	1/4-in FNPT	1/2-in FNPT	First Stage (2): Down Second Stage: Opposite Gauge Taps									
	MEGR-1632E-BCIXA	900,000	1/4-in FNPT	1/4-in FNPT	Over Inlet									
	MEGR-1632E-CFH	950,000	1/4-in FNPT	3/4-in FNPT	First Stage (2): Down Second Stage: Opposite Gauge Taps									
2 PSI (0.14 bar) SERVICE	MEGR-1632E-CFHXA	900,000	FPOL	1/2-in FNPT	Over Inlet	4 psi (0.28 bar)	50 psig (3.4 bar)	5 psig (0.34 bar)	7/32-in (5.6 mm)	10 psig (0.69 bar)	15 psig (1.03 bar)	2 psig (0.14 bar)	1 to 2.2 psi (0.069 to 0.15 bar)	WHITE
	MEGR-1632E-HCH	900,000	FPOL	1/2-in FNPT	Over Inlet									
	MEGR-1632E-HCHXA	900,000	FPOL	1/2-in FNPT	Over Inlet									
	MEGR-1632E-JFH	950,000	FPOL	3/4-in FNPT	First Stage (2): Down Second Stage: Opposite Gauge Taps									
	MEGR-1632E-JFHXA	950,000	FPOL	3/4-in FNPT	First Stage (2): Down Second Stage: Opposite Gauge Taps									
	MEGR-1652E-DFH	1,300,000	3/4-in FNPT	3/4-in FNPT	Over Inlet									
	MEGR-1622H-BGJ	2,200,000	1/2-in FNPT	1/2-in FNPT	Over Inlet									
	MEGR-1622H-BGK	2,100,000	1/2-in FNPT	1/2-in FNPT	Over Inlet									
	MEGR-1622H-HGJ	2,300,000	FPOL	1/2-in FNPT	Over Inlet									
	MEGR-1622H-HGJ	2,300,000	2X FPOL	1/2-in FNPT	Over Inlet									
First Stage	MEGR-1622H-HGK	2,200,000	FPOL	3/4-in FNPT	Over Outlet	1.8 psi (1.24 bar)	Not Applicable	Not Applicable	7/32-in (5.6 mm)	250 psig (17.2 bar)	250 psig (17.2 bar)	5 psi (0.34 bar)	8 to 12 psi (0.55 to 0.83 bar)	Red
	MEGR-1622H-IGJ	2,750,000	FPOL	3/4-in FNPT	Over Outlet									
	MEGR-1622H-IGJ	2,750,000	2X FPOL	3/4-in FNPT	Over Outlet									
	MEGR-1622H-JGK	2,650,000	FPOL	3/4-in FNPT	Over Outlet									
	MEGR-1622H-DGJ	2,500,000	3/4-in FNPT	3/4-in FNPT	Over Outlet									
	MEGR-1622H-DGJ	2,500,000	3/4-in FNPT	3/4-in FNPT	Over Outlet									

























(1) Capacities based on:  
 Second Stage: 15 psig (1.03 bar) inlet pressure with 2-inch w.c. (5 mbar) droop.  
 First Stage: 30 psig (2.07 bar) inlet pressure with 6 and 2-inch w.c. (5 mbar) droop.  
 (2) Integral First Stage vent size: 7/16-24 UN thread for 1/4-inch OD copper tube inverted flare fitting.



# DOMESTIC - FIRST/SECOND STAGE

## REFERENCE GUIDE

EXCELSIOR-110 REGULATORS

LOAD BTU/HR.	DISTANCE Maximum distance from 1st Stage Regulator to 2nd Stage Regulator	PIPE SIZE Between 1st and 2nd Stage Regulator	MEC REGULATOR	MEC PIGTAILS			DIELECTRIC UNIONS										
				1/4" X POL	Length	Part. No.	MNPT X M. FLARE	Part. No.									
400,000	80 feet	1/2" CTS Iron pipe or 1/2" OD copper tubing @ 10 psi	 <p>1st STAGE MEGR-1122H-AAJ 1/4" X 1/2"</p>  <p>1st STAGE MEGR-1222H-BGF F. POL X 1/2"</p>  <p>2nd STAGE MEGR-1222-BAF 1/2" X 1/2"</p>  <p>2nd STAGE MEGR-1252-BAF 1/2" X 1/2" BACKMOUNT</p>	1/4" X POL	Length	Part. No.		<table border="1"> <tr> <td>1/2"</td> <td>3/8"</td> <td>ME690-4-6</td> </tr> <tr> <td>1/2"</td> <td>1/2"</td> <td>ME690-4-8</td> </tr> <tr> <td>1/2"</td> <td>5/8"</td> <td>ME690-4-10</td> </tr> </table>	1/2"	3/8"	ME690-4-6	1/2"	1/2"	ME690-4-8	1/2"	5/8"	ME690-4-10
				1/2"	3/8"	ME690-4-6											
1/2"	1/2"	ME690-4-8															
1/2"	5/8"	ME690-4-10															
3/8" tube OD	12"	ME1689-12	1/4" tube OD	12"	ME1669-12	1/4" tube OD	6"	ME1669-06									
3/8" tube OD	12"	ME1680-12	1/4" tube OD	12"	ME1664-12	3/8" tube OD	6"	ME1680-06									
600,000	40 Feet	1/2" CTS Iron pipe or 1/2" OD copper tubing @ 10 psi	 <p>1st STAGE MEGR-1122H-AAJ 1/4" X 1/2"</p>  <p>1st STAGE MEGR-1222H-BGF F. POL X 1/2"</p>  <p>2nd STAGE MEGR-1652-CFF 1/2" X 3/4" BACKMOUNT</p>  <p>2nd STAGE MEGR-1622-CFF 1/2" X 3/4" STRAIGHT OUTLET</p>	1/4" X POL	Length	Part. No.		<table border="1"> <tr> <td>1/2"</td> <td>3/8"</td> <td>ME690-4-6</td> </tr> <tr> <td>1/2"</td> <td>1/2"</td> <td>ME690-4-8</td> </tr> <tr> <td>1/2"</td> <td>5/8"</td> <td>ME690-4-10</td> </tr> </table>	1/2"	3/8"	ME690-4-6	1/2"	1/2"	ME690-4-8	1/2"	5/8"	ME690-4-10
	1/2"	3/8"		ME690-4-6													
	1/2"	1/2"		ME690-4-8													
1/2"	5/8"	ME690-4-10															
100 Feet	5/8" OD copper tubing @ 10 psi	1/4" tube OD	12"	ME1669-12	1/4" tube OD	6"	ME1669-06										
3/8" tube OD	12"	ME1680-12	1/4" tube OD	12"	ME1664-12	3/8" tube OD	6"	ME1680-06									
1000 Feet	3/4" IPS Iron pipe @ 10 psi	3/8" tube OD	6"	ME1680-06													
800,000	20 Feet	1/2" OD copper tubing @ 10 psi	 <p>1st STAGE MEGR-1122H-AAJ 1/4" X 1/2"</p>  <p>1st STAGE MEGR-1122H-BGF F. POL X 1/2"</p>  <p>2nd STAGE MEGR-1652-DFD 3/4" X 3/4" BACKMOUNT</p>  <p>2nd STAGE MEGR-1622-CFF 3/4" X 3/4" STRAIGHT OUTLET</p>	1/4" X POL	Length	Part. No.		<table border="1"> <tr> <td>3/4"</td> <td>3/8"</td> <td>ME690-6-6</td> </tr> <tr> <td>3/4"</td> <td>1/2"</td> <td>ME690-6-8</td> </tr> <tr> <td>3/4"</td> <td>5/8"</td> <td>ME690-6-10</td> </tr> </table>	3/4"	3/8"	ME690-6-6	3/4"	1/2"	ME690-6-8	3/4"	5/8"	ME690-6-10
	3/4"	3/8"		ME690-6-6													
	3/4"	1/2"		ME690-6-8													
3/4"	5/8"	ME690-6-10															
70 Feet	5/8" OD copper tubing @ 10 psi	1/4" tube OD	12"	ME1669-12	1/4" tube OD	6"	ME1669-06										
3/8" tube OD	12"	ME1680-12	1/4" tube OD	12"	ME1664-12	3/8" tube OD	6"	ME1680-06									
600 Feet	3/4" IPS Iron pipe @ 10 psi	3/8" tube OD	6"	ME1680-06													
1,000,000	10 Feet	1/2" CTS Iron pipe or copper tubing @ 10 psi	 <p>1ST STAGE MEGR-1622H-HGJ F. POL X 1/2"</p>  <p>2ND STAGE MEGR-1622-DFD 3/4" X 3/4" STRAIGHT OUTLET</p>	1/4" X POL	Length	Part. No.		<table border="1"> <tr> <td>3/4"</td> <td>3/8"</td> <td>ME690-6-6</td> </tr> <tr> <td>3/4"</td> <td>1/2"</td> <td>ME690-6-8</td> </tr> <tr> <td>3/4"</td> <td>5/8"</td> <td>ME690-6-10</td> </tr> </table>	3/4"	3/8"	ME690-6-6	3/4"	1/2"	ME690-6-8	3/4"	5/8"	ME690-6-10
	3/4"	3/8"		ME690-6-6													
	3/4"	1/2"		ME690-6-8													
3/4"	5/8"	ME690-6-10															
50 Feet	5/8" copper tubing @ 10 psi	3/8" tube OD	12"	ME1664-12	3/8" tube OD	6"	ME1680-06										
400 Feet	3/4" IPS Iron pipe @ 10 psi	3/8" tube OD	6"	ME1680-06													
2,000,000	10 Feet	5/8" copper tubing @ 10 psi	 <p>1ST STAGE MEGR-1622H-JGJ F. POL X 3/4"</p>  <p>2ND STAGE MEGR-1HSRL-BFC 3/4" X 3/4" STRAIGHT OUTLET</p>	POL X POL	Length	Part. No.		<table border="1"> <tr> <td>3/4"</td> <td>3/8"</td> <td>ME690-6-6</td> </tr> <tr> <td>3/4"</td> <td>1/2"</td> <td>ME690-6-8</td> </tr> <tr> <td>3/4"</td> <td>5/8"</td> <td>ME690-6-10</td> </tr> </table>	3/4"	3/8"	ME690-6-6	3/4"	1/2"	ME690-6-8	3/4"	5/8"	ME690-6-10
	3/4"	3/8"		ME690-6-6													
3/4"	1/2"	ME690-6-8															
3/4"	5/8"	ME690-6-10															
100 Feet	3/4" IPS Iron pipe @ 10 psi	3/8" tube OD	12"	ME1664-12	3/8" tube OD	6"	ME1680-06										
2,500,000	80 Feet	3/4" IPS Iron pipe @ 10 psi	 <p>1ST STAGE MEGR-1627/7710 1" X 1"</p>  <p>2ND STAGE MEGR-CS1200IR6EC6 1-1/4" X 1-1/4"</p>					<table border="1"> <tr> <td>3/4"</td> <td>3/8"</td> <td>ME690-6-6</td> </tr> <tr> <td>3/4"</td> <td>1/2"</td> <td>ME690-6-8</td> </tr> <tr> <td>3/4"</td> <td>5/8"</td> <td>ME690-6-10</td> </tr> </table>	3/4"	3/8"	ME690-6-6	3/4"	1/2"	ME690-6-8	3/4"	5/8"	ME690-6-10
	3/4"	3/8"		ME690-6-6													
3/4"	1/2"	ME690-6-8															
3/4"	5/8"	ME690-6-10															
225 Feet	1" IPS Iron pipe @ 10 psi																



# DOMESTIC - FIRST STAGE



**MEGR-1122H**  
Compact Series



**MEGR-1222H**  
F. POL Compact Series



**MEGR-1622H**  
Full Size Series

These first stage regulators are used to reduce LP gas tank pressures for a second stage regulator (normally 10 PSIG). All MEC first stage regulators are red indicating high outlet pressure. First stage full size regulator vents have 3/4" FNPT tapped ports and E-Z Grip screens located over the outlet. Both the MEGR-1122H and the MEGR-1622H series offer optimal relief performance that exceeds UL test requirements providing double failure overpressure protection when used with MEC MEGR-1622 & MEGR-1652 series second stage regulators. All MEC **EXCELA-FLO** domestic regulators feature a 25 year recommended replacement life and the MEC exclusive tear away leak check adhesive sticker.



## SPECIFICATIONS

- Type:** First Stage
- Max. Inlet Pressure:** 250 PSIG
- Exterior Finish:** Red Powder Coat
- Interior Finish:** Red Powder Coat
- Orifice Size:** .150" (Compact) & .219" Full
- Diaphragm:** Fabric Reinforced NBR Molded Lip O-Ring Bonnet/Body Seal
- Relief Type:** Internal Relief - Spring Loaded
- Bonnet / Body Material:** Die Cast Aluminum
- Seat Material:** Fluorocarbon (FKM)
- Listings:** cUL US / UL 144
- Mounting Holes:** Standard 3-1/2" Center
- Pressure Taps:** #54 Orifice, 1/8" FNPT, Plugged (2)
- Relief Travel Stop:** Molded in Adjustment Cap - Gray (Compact), Black (Full Size)

**MEGR-1122H Series:** Offers a compact first stage regulator design perfect for tight applications such as underground tank domes. They feature an adjustment range from 9-12 PSIG (factory set @ 10 PSIG), stainless steel internal components, fluorocarbon (FKM) seat discs, molded lip fabric reinforced diaphragms and large aluminum precision machined orifice to minimize freeze ups while providing superior downstream regulation and maximum corrosion resistance against weather or contaminated gas. Compact series regulators feature 3/8" FNPT drip lip vent openings.

**MEGR-1222H Series:** Offers a compact first stage regulator design perfect for tight applications such as underground tank domes. They feature an adjustment range from 9-12 PSIG (factory set @ 10 PSIG), stainless steel internal components, fluorocarbon (FKM) seat discs, molded lip fabric reinforced diaphragms and large aluminum precision machined orifice to minimize freeze ups while providing superior downstream regulation and maximum corrosion resistance against weather or contaminated gas.

**MEGR-1622H Series:** Offers all of the same features as the compact MEGR-1122H Series in a full size version. Our full size MEGR-1622H Series has a large fabric reinforced diaphragm for superior downstream regulation, heavy duty wrench flats, and a large 3/4" FNPT tapped drip lip vent to help prevent relief vent blockage.

Part No.	Type	Capacity in BTU/H LPG <sup>(1)</sup>	Inlet	Outlet	Vent Port	Outlet Adj. Range (PSI)	Outlet Set Point (PSI)
MEGR-1122H-AAJ	Compact	1,000,000	1/4" FNPT	1/2" FNPT	3/8" FNPT	8-12	10
MEGR-1122H-AAJXB <sup>(2)</sup>	Compact	1,000,000	1/4" FNPT	1/2" FNPT	3/8" FNPT	8-12	10
MEGR-1222H-BGF	Compact	1,000,000	F. POL	1/2" FNPT	3/8" FNPT	9-12	10
MEGR-1222H-BGFXB <sup>(2)</sup>	Compact	1,000,000	F. POL	1/2" FNPT	3/8" FNPT	9-12	10
MEGR-1622H-BGJ	Full Size	2,200,000	1/2" FNPT	1/2" FNPT	3/4" FNPT	8-12	10
MEGR-1622H-DGJ	Full Size	2,500,000	3/4" FNPT	3/4" FNPT	3/4" FNPT	8-12	10
MEGR-1622H-HGJ	Full Size	2,300,000	F. POL	1/2" FNPT	3/4" FNPT	8-12	10
MEGR-1622H-JGJ	Full Size	2,750,000	F. POL	3/4" FNPT	3/4" FNPT	8-12	10

(1) Based on 30 PSIG Inlet pressure and 20% droop  
 (2) Indicates vent orientation over pressure taps



## DOMESTIC - FIRST STAGE

### 5 PSI OUTLET PRESSURE

These first stage regulators are used to reduce LP gas tank pressures for a second stage regulator (5 PSIG). All MEC first stage regulators are red indicating high outlet pressure. First stage regulator vents have 3/4" FNPT tapped ports and E-Z Grip screens located over the outlet. The MEGR-1622H series offer optimal relief performance that well exceeds UL test requirements providing double failure overpressure protection when used with MEC MEGR-1622, MEGR-1642 & MEGR-1652 Series Second Stage regulators. All MEC Excelsa-Flo domestic regulators feature a 25 year recommended replacement life and our exclusive tear away leak check adhesive sticker.



Part No.	Type	Capacity in BTU/H LPG <sup>(1)</sup>	Inlet	Outlet	Outlet Adj. Range (PSI)	Outlet Set Point (PSI)
MEGR-1622H-BGK	Full Size	2,100,000	1/2" FNPT	1/2" FNPT	4-6	5
MEGR-1622H-HGK	Full Size	2,200,000	F. POL	1/2" FNPT	4-6	5
MEGR-1652H-JGK	Full Size	2,650,000	F. POL	3/4" FNPT	4-6	5

(1) Based on 30 PSIG inlet pressure and 20% droop.

## DOMESTIC - FIRST STAGE

### FEMALE POL TEE INLET

These first stage F. POL tee inlet regulators are used to reduce LP gas tank pressures for a second stage regulator (normally 10 PSIG) in a multiple tank manifold installation without adapters or tees. All MEC first stage regulators are red indicating high outlet pressure. Compact First stage regulator vents have 3/8" FNPT tapped ports and E-Z Grip screens located over the outlet. The MEGR-1222HT series offers optimal relief performance that well exceeds UL test requirements providing double failure overpressure protection when used with MEC MEGR-1622, MEGR-1642 & MEGR-1652 Series Second Stage regulators. All MEC Excelsa-Flo domestic regulators feature a 25 year recommended replacement life and our exclusive tear away leak check adhesive sticker.

PATENT PENDING



**MEGR-1222HT**  
Compact Tee Inlet Series

#### SPECIFICATIONS

- Type:** First Stage
- Max. Inlet Pressure:** 250 PSIG
- Exterior Finish:** Red Powder Coat
- Orifice Size:** .14" (Compact) & 7/32" Full
- Diaphragm:** Fabric Reinforced NBR Molded Lip O-Ring Bonnet/Body Seal
- Relief Type:** Internal Relief - Spring Loaded
- Bonnet / Body Material:** Die Cast Aluminum
- Seat Material:** Fluorocarbon (FKM)
- Listings:** cUL<sub>US</sub> / UL 144
- Mounting Holes:** Standard 3-1/2" Center
- Pressure Taps:** #54 Orifice 1/8" FNPT Plugged (2)
- Relief Travel Stop:** Molded in Adjustment Cap - Gray (Compact), Black (Full Size)



Part No.	Type	Capacity in BTU/H LPG <sup>(1)</sup>	Inlet	Outlet	Outlet Adj. Range (PSI)	Outlet Set Point (PSI)
MEGR-1222HT-BGF	Compact	1,000,000	F. POL/Tee	1/2" FNPT	9-12	10
MEGR-1622HT-HGJ	Full	2,300,000	F. POL/Tee	1/2" FNPT	9-12	10
MEGR-1622HT-JGJ	Full	2,750,000	F. POL/Tee	3/4" FNPT	9-12	10

(1) Based on 30 PSIG Inlet pressure and 20% droop



# DOMESTIC - SECOND STAGE

PATENT PENDING



MEGR-1222  
Compact Series

PATENT PENDING



MEGR-1252  
Compact Back Mount

PATENT PENDING



MEGR-1622  
Full Size Series

PATENT PENDING



MEGR-1652  
Full Size  
Back Mount Series

These second stage regulators are used to reduce outlet pressures from first stage regulators (normally 10 PSIG) to 11" WC in domestic installations. All MEC second stage regulators are green indicating low outlet pressure. Second stage full size regulator vents have 3/4" FNPT tapped ports and our exclusive E-Z grip screens located over the inlet. All MEC second stage domestic regulators feature a stainless steel inlet filter screen to reduce debris from passing through the regulator. Both the MEGR-1622 and the MEGR-1652 Series offer optimal relief performance that exceeds UL test requirements providing double failure overpressure protection (no more than 2 PSI downstream pressure) when used with MEGR-1122H and MEGR-1622H Series First Stage regulators. All MEC Excela-Flo domestic regulators feature a 25 year recommended replacement life and our exclusive tear away leak check adhesive sticker.

## SPECIFICATIONS

- Type:** Second Stage
- Max. Inlet Pressure:** 10 PSIG
- Exterior Finish:** Green Powder Coat
- Interior Finish:** Green Powder Coat
- Orifice Size:** .140" (Compact) & .219" (Full)
- Diaphragm:** Fabric Reinforced (NBR) Molded Lip O-Ring Bonnet Body Seal
- Relief Type:** Internal Relief - Spring Loaded
- Bonnet / Body Material:** Die Cast Aluminum
- Seat Material:** Fluorocarbon (FKM)
- Listings:** / UL 144
- Mounting Holes:** Standard 3-1/2" Center
- Pressure Taps:** #54 Orifice 1/8" FNPT Plugged (2)
- Relief Travel Stop:** Molded In Adjustment Cap - Black (Full Size), Gray (Compact)



**MEGR-1222 & MEGR-1252 Series:** Offers a compact second stage regulator design perfect for lower BTU applications. They feature an adjustable range from 9.5-13" WC (factory set @ 11" WC), stainless steel internal components, fluorocarbon (FKM) seat discs, molded lip fabric reinforced diaphragms and large aluminum precision machined orifices providing superior downstream regulation and maximum corrosion resistance against weather or contaminated gas. The MEGR-1222 Series have both the inlet and outlet in line where the MEGR-1252 series have a rear discharge back mount outlet for convenient wall mount applications.

### MEGR-1622 & MEGR-1652 Series:

Offers all of the same features as the compact MEGR-1122 Series but in a full size, high capacity version. Our full size second stage regulators have a large fabric reinforced diaphragm for superior downstream regulation, heavy duty wrench flats, and a large 3/4" FNPT tapped drip lip vent to help prevent relief valve blockage. The MEGR-1622 Series have both the inlet and outlet in line where the MEGR-1652 series have a rear discharge back mount outlet for convenient wall mount applications.

Part No.	Type	Capacity in BTU/H LPG <sup>(1)</sup>	Inlet	Outlet	Outlet Adj. Range ("WC)	Outlet Set Point ("WC)
MEGR-1222-BAF	Compact	500,000	1/2" FNPT	1/2" FNPT	9.5-13	11
MEGR-1252-BAF <sup>(2)</sup>	Back Mount	450,000	1/2" FNPT	1/2" FNPT	9.5-13	11
MEGR-1252-CFF <sup>(2)</sup>	Back Mount	650,000	1/2" FNPT	3/4" FNPT	9.5-13	11
MEGR-1622-BCF	Full Size	710,000	1/2" FNPT	1/2" FNPT	9-13	11
MEGR-1622-CFF	Full Size	1,300,000	1/2" FNPT	3/4" FNPT	9-13	11
MEGR-1622-CFFXO <sup>(3)</sup>	Full Size	1,300,000	1/2" FNPT	3/4" FNPT	9-13	11
MEGR-1622-DFF	Full Size	1,300,000	3/4" FNPT	3/4" FNPT	9-13	11
MEGR-1622-DFFXO <sup>(3)</sup>	Full Size	1,300,000	3/4" FNPT	3/4" FNPT	9-13	11
MEGR-1652-CFF <sup>(2)</sup>	Back Mount	1,000,000	1/2" FNPT	3/4" FNPT	9-13	11
MEGR-1652-DFF <sup>(2)</sup>	Back Mount	1,000,000	3/4" FNPT	3/4" FNPT	9-13	11

(1) Based on 10 PSIG inlet pressure and 20% droop  
 (2) Indicates back mount configuration  
 (3) Indicates vent over outlet





# DOMESTIC - SECOND STAGE

## SIDE OUTLET

These second stage regulators are used to reduce outlet pressures from first stage regulators (normally 10 PSI) to 11" WC in domestic installations. All MEC second stage regulators are green indicating low outlet pressure. Second stage regulator vents have 3/4" FNPT tapped ports and our exclusive E-Z grip screens located over the inlet. All MEC second stage domestic regulators feature a stainless steel inlet filter screen to reduce debris from passing through the regulator. The MEGR-1642 Series offers optimal relief performance that well exceeds UL test requirements providing double failure overpressure protection (no more than 2 PSI downstream pressure) when used with MEGR-1122H, MEGR-1222H and MEGR-1622H Series First Stage regulators. All MEC Excelsa-Flo domestic regulators feature a 25 year recommended replacement life and our exclusive tear away leak check adhesive sticker.

**MEGR-1642 Series:** Features an adjustable range from 9-13" WC (factory set @ 11" WC), stainless steel internal components, fluorocarbon (FKM) seat discs, molded lip fabric reinforced diaphragms and large aluminum precision machined orifices providing superior downstream regulation and maximum corrosion resistance against weather or contaminated gas.

Our full size second stage regulators have a large fabric reinforced diaphragm for superior downstream regulation, heavy duty wrench flats, and a large 3/4" FNPT tapped drip lip vent to help prevent relief valve blockage. The MEGR-1642 Series has the outlet at 90 degrees from the inlet making it ideal for vapor meter installations.

### SPECIFICATIONS

- Type:** Second Stage
- Max. Inlet Pressure:** 10 PSIG
- Exterior Finish:** Green Powder Coat
- Interior Finish:** Green Powder Coat
- Orifice Size:** 7/32" (Full)
- Diaphragm:** Fabric Reinforced (NBR) Molded Lip O-Ring Bonnet / Body Seal
- Relief Type:** Internal Relief - Spring Loaded
- Bonnet / Body Material:** Die Cast Aluminum
- Seat Material:** Fluorocarbon (FKM)
- Listings:** cUL<sub>US</sub> / UL 144
- Mounting Holes:** Standard 3-1/2" Center
- Pressure Taps:** #54 Orifice 1/8" FNPT Plugged (2)
- Relief Travel Stop:** Molded In Adjustment Cap - Black



**MEGR-1642-DFE  
Full Size**



MEC Excelsa-Flo Second Stage Domestic Regulators						
Part No.	Type	Capacity in BTU/H LPG <sup>(1)</sup>	Inlet	Outlet	Outlet Adj. Range ("WC)	Outlet Set Point ("WC)
MEGR-1642-DFE <sup>(2)</sup>	Full Size Side Outlet	900,000	3/4" FNPT	3/4" FNPT	9-13	11

(1) Based on 10 PSIG inlet pressure and 20% droop  
 (2) Indicates side outlet configuration

## UNIVERSAL REGULATOR BRACKET

Universal Slotted H Style Bracket for both full size and compact domestic regulators

### FEATURES

- Anodized aluminum stamping for maximum strength and durability
- Slotted and elongated regulator mounting holes for quick, convenient and secure regulator retention
- Multiple screw holes for easy and reliable building/structure installation



**MEGR-100C**



# DOMESTIC - SECOND STAGE

## 2 PSI OUTLET

These 2 PSI service regulators are used to reduce outlet pressures from first stage regulators (normally 10 PSI) to a nominal 2 PSI. 2 PSI service regulators are used in conjunction with an LPG line regulator either at the indoor appliance or a remote manifold distribution header inlet. All MEC 2 PSI service regulators are white with black adjustment caps. The full size 2 PSI service regulators have 3/4" FNPT tapped vents and our exclusive E-Z grip screens located over the inlet. All MEC 2 PSI service regulators feature a stainless steel inlet filter screen to reduce debris from passing through the regulator. Both the MEGR-1622E and MEGR-1652E series offer optimal relief performance that exceeds UL test requirements. All MEC **Excelsa-Flo** domestic regulators feature a 25 year recommended replacement life and our exclusive tear away leak check adhesive sticker.

### SPECIFICATIONS

- Type:** Second Stage 2 PSI
- Max. Inlet Pressure:** 10 PSI
- Exterior Finish:** White Powder Coat
- Interior Finish:** White Powder Coat
- Orifice Size:** .219"
- Seat Material:** Fluorocarbon (FKM)
- Diaphragm:** Fabric Reinforced (NBR) / Molded Lip O-Ring Bonnet/Body Seal
- Relief Type:** Internal Relief - Spring Loaded
- Bonnet / Body Material:** Die Cast Aluminum
- Listings:** cUL<sub>US</sub> / UL 144
- Mounting Holes:** Standard 3-1/2" Center
- Pressure Taps:** #54 Orifice, 1/8" FNPT, Plugged (2)
- Relief Travel Stop:** Molded in Adjustment Cap - Black



#### MEGR-1622E Series:

Offers a full size high capacity molded lip fabric reinforced diaphragm, stainless steel internal components, fluorocarbon (FKM) seat discs, precision machined aluminum orifices, and an adjustment range from 1.0-2.2 PSI (factory set @ 2 PSI) providing superior downstream regulation and maximum corrosion resistance against weather or contaminated gas.



#### MEGR-1652E Series:

Offers all of the same features as the MEGR-1622E Series but with a rear discharge back mount outlet for convenient wall mount applications.



Tested in the U.S.A

Part No.	Type	Capacity in BTU/H LPG <sup>(1)</sup>	Inlet	Outlet	Vent Port	Outlet Adj. Range (PSI)	Outlet Set Point (PSI)
MEGR-1622E-BCH	Full Size	1,100,000	1/2" FNPT	1/2" FNPT	3/4" FNPT	1.0-2.2	2
MEGR-1622E-DCH	Full Size	1,400,000	3/4" FNPT	3/4" FNPT	3/4" FNPT	1.0-2.2	2
MEGR-1652E-DFH <sup>(2)</sup>	Back Mount	1,300,000	3/4" FNPT	3/4" FNPT	3/4" FNPT	1.0-2.2	2













(1) Based on 10 PSIG inlet pressure and 20% droop.  
 (2) Indicates back mount configuration.



# DOMESTIC - INTEGRAL TWO STAGE

## REFERENCE GUIDE

EXCELSIOR-110 REGULATORS

LOAD BTU/HR.	DISTANCE maximum distance from regulator outlet to furthest appliance	PIPE TO APPLIANCE	MEC REGULATOR	MEC PIGTAILS												
100,000	10 feet	1/2" CTS Iron Pipe or copper tubing @ 11" water column regulator set pressure	 MEGR-1232-HBF F. POL X 1/2" OR MEGR-1232-BBF 1/4" X 1/2"	<table border="1"> <tr><th>POL X POL</th><th>Length</th><th>Part. No.</th></tr> <tr><td>3/8" tube OD</td><td>12"</td><td>ME1680-12</td></tr> <tr><td>1/4" tube OD</td><td>12"</td><td>ME1664-12</td></tr> <tr><td>3/8" tube OD</td><td>6"</td><td>ME1680-06</td></tr> </table>	POL X POL	Length	Part. No.	3/8" tube OD	12"	ME1680-12	1/4" tube OD	12"	ME1664-12	3/8" tube OD	6"	ME1680-06
	POL X POL	Length		Part. No.												
	3/8" tube OD	12"		ME1680-12												
1/4" tube OD	12"	ME1664-12														
3/8" tube OD	6"	ME1680-06														
35 feet	5/8" copper tubing @ 11" water column regulator set pressure	 MEGR-1232-HBF F. POL X 1/2" OR MEGR-1232-BBF 1/4" X 1/2"														
100 feet	3/4" IPS Iron pipe @ 11" water column regulator set pressure															
200,000	10 Feet	5/8" copper tubing @ 11" water column regulator set pressure	 MEGR-1232-HBF F. POL X 1/2" OR MEGR-1232-BBF 1/4" X 1/2"	<table border="1"> <tr><th>1/4" X POL</th><th>Length</th><th>Part. No.</th></tr> <tr><td>3/8" tube OD</td><td>12"</td><td>ME1689-12</td></tr> <tr><td>1/4" tube OD</td><td>12"</td><td>ME1669-12</td></tr> <tr><td>1/4" tube OD</td><td>6"</td><td>ME1669-06</td></tr> </table>	1/4" X POL	Length	Part. No.	3/8" tube OD	12"	ME1689-12	1/4" tube OD	12"	ME1669-12	1/4" tube OD	6"	ME1669-06
	1/4" X POL	Length		Part. No.												
3/8" tube OD	12"	ME1689-12														
1/4" tube OD	12"	ME1669-12														
1/4" tube OD	6"	ME1669-06														
50 Feet	3/4" IPS Iron pipe @ 11" water column regulator set pressure	 MEGR-1232-HBF F. POL X 1/2" OR MEGR-1232-BBF 1/4" X 1/2"														
300,000	30 Feet			3/4" IPS Iron pipe @ 11" water column regulator set pressure	 MEGR-1632-HCF F. POL X 1/2" OR MEGR-1632-BCF 1/4" X 1/2"	<table border="1"> <tr><th>POL X POL</th><th>Length</th><th>Part. No.</th></tr> <tr><td>3/8" tube OD</td><td>12"</td><td>ME1680-12</td></tr> <tr><td>1/4" tube OD</td><td>12"</td><td>ME1664-12</td></tr> <tr><td>3/8" tube OD</td><td>6"</td><td>ME1680-06</td></tr> </table>	POL X POL	Length	Part. No.	3/8" tube OD	12"	ME1680-12	1/4" tube OD	12"	ME1664-12	3/8" tube OD
	POL X POL	Length	Part. No.													
3/8" tube OD	12"	ME1680-12														
1/4" tube OD	12"	ME1664-12														
3/8" tube OD	6"	ME1680-06														
70 Feet	1" IPS Iron pipe @ 11" water column regulator set pressure	 MEGR-1632-HCF F. POL X 1/2" OR MEGR-1632-BCF 1/4" X 1/2"														
	400,000			20 Feet	3/4" IPS Iron pipe @ 11" water column regulator set pressure	 MEGR-1632-JFF F. POL X 3/4" OR MEGR-1632-CFF 1/4" X 3/4"	<table border="1"> <tr><th>1/4" X POL</th><th>Length</th><th>Part. No.</th></tr> <tr><td>3/8" tube OD</td><td>12"</td><td>ME1689-12</td></tr> <tr><td>1/4" tube OD</td><td>12"</td><td>ME1669-12</td></tr> <tr><td>1/4" tube OD</td><td>6"</td><td>ME1669-06</td></tr> </table>	1/4" X POL	Length	Part. No.	3/8" tube OD	12"	ME1689-12	1/4" tube OD	12"	ME1669-12
1/4" X POL		Length	Part. No.													
3/8" tube OD	12"	ME1689-12														
1/4" tube OD	12"	ME1669-12														
1/4" tube OD	6"	ME1669-06														
60 Feet	1" IPS Iron pipe @ 11" water column regulator set pressure	 MEGR-1632-JFF F. POL X 3/4" OR MEGR-1632-CFF 1/4" X 3/4"														

**Instructions:**

- Determine the total gas demand for the system by adding up the BTU/hr input from the appliance nameplates and adding demand as appropriate for future appliances.
- For second stage or integral twin stage piping:
  - Measure length of piping required from outlet of regulator to the appliance furthest away. No other length is necessary to do the sizing.
  - Make a simple sketch of the piping, as shown.
  - Determine the capacity to be handled by each section of piping. For example, the capacity of the line between a and b must handle the total demand of appliances A, B, and C; the capacity of the line from c to d must handle only appliance B, etc.
  - Using one of the above Tables, select proper size of tubing or pipe for each section of piping, using values in BTU/hr for the length determined from step #2-A. If exact length is not on chart, use next longer length. Do not use any other length for this purpose! Simply select the size that shows at least as much capacity as needed for each piping section.
- For piping between first and second stage regulators:
  - For a simple system with only one second stage regulator, merely measure length of piping required between outlet of first stage regulator and inlet of second stage regulator. Select piping or tubing required from one of the Tables.
  - For systems with multiple second stage regulators, measure length of piping required to reach the second stage regulator that is furthest away. Make a simple sketch, and size each leg of piping using Table 1, 2, or 3 using values shown in column corresponding to the length as measured above, same as when handling second stage piping.

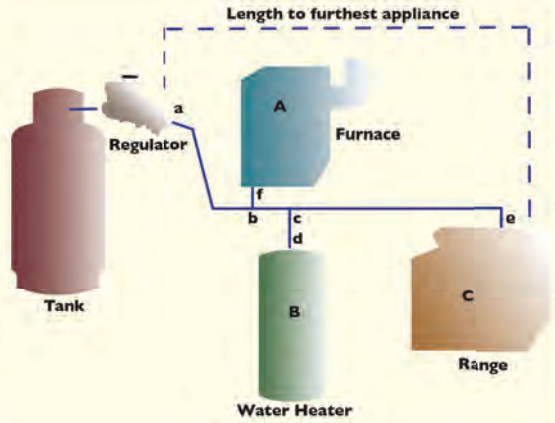

**Length to furthest appliance**



# DOMESTIC - INTEGRAL TWO STAGE TEE INLET

These integral two-stage regulators combine the first and second stage regulator set-up into one convenient unit converting tank pressure to 11" WC with the convenience of a F. POL Tee inlet for multiple tank applications. All MEC integral two-stage domestic regulators are gray indicating low outlet pressure. Integral two-stage regulators are recommended for installations with short piping distances, but provide the same advantages of two-stage regulation with a single unit. All MEC integral two-stage regulator vent have tapped ports (7/16 -24-First Stage) (3/4" FNPT - Second Stage) and our exclusive E-Z Grip screens located over the outlet. Both the MEGR-1232T and MEGR-1632T series offer optimal relief performance that well exceeds UL test requirements providing over pressure protection of no more than 2 PSI downstream pressure. MEC **EXCELA-FLO** integral two-stage domestic regulators feature a 25 year recommended replacement life, our exclusive Tri-Tap™ (tank, 10 PSI, 11" WC) pressure port system and tear away leak check adhesive sticker. NOTE: All models available in "XA" configuration with both first & second stage vents located opposite pressure taps and tee inlets perpendicular to vents specifically for horizontal installation.

## SPECIFICATIONS

- Type:** Integral Two-Stage
- Max. Inlet Pressure:** 250 PSIG
- Exterior Finish:** Gray Powder Coat
- Interior Finish:** Gray Powder Coat
- Orifice Size:** .17" (Compact) & 7/32" (Full)
- Seat Material:** Fluorocarbon (FKM)
- Diaphragm:** Fabric Reinforced NBR/Molded Lip O-Ring  
Bonnet/Body Seal
- Relief Type:** Internal Relief - Spring Loaded
- Bonnet / Body Material:** Die Cast Aluminum
- Listings:** cUL<sub>us</sub> / UL 144
- Mounting Holes:** Standard 3-1/2" Center
- Pressure Taps:** #54 Orifice 1/8" FNPT Plugged (3)
- Relief Travel Stop:** Molded in Adjustment Cap -  
Gray (Compact), Black (Full Size)



**MEGR-1232T Compact Series:** Offers a compact integral two-stage regulator design perfect for lower BTU applications and confined spaces. They feature an adjustment range from 9-13" WC (factory set @ 11" WC). Stainless steel integral components, fluorocarbon (FKM) seat discs, molded lip fabric reinforced diaphragms, and large precision machined aluminum orifices providing superior downstream regulation and maximum corrosion resistance against weather or contaminated gas.



**MEGR-1632 Full Size Series:** Offers all of the same features as the compact MEGR-1232 series in a full size high capacity version. The full size MEGR-1632 diaphragm provides superior downstream regulation, has heavy duty wrench flats and a large 3/4" FNPT tapped drip lip vent to help prevent relief vent blockage.

Part No.	Type	Capacity in BTU/H LPG <sup>(1)</sup>	Inlet	Outlet	Outlet Adj. Range ("WC)	Outlet Set Point ("WC)
MEGR-1232T-HBF	Compact	450,000	F. POL Tee	1/2" FNPT	9.5-13	11
MEGR-1232T-HBFXA <sup>(2)</sup>	Compact	450,000	F. POL Tee	1/2" FNPT	9.5-13	11
MEGR-1632T-HCF	Full Size	700,000	F. POL Tee	1/2" FNPT	9-13	11
MEGR-1632T-HCFXA <sup>(2)</sup>	Full Size	700,000	F. POL Tee	1/2" FNPT	9-13	11
MEGR-1632T-JFF	Full Size	900,000	F. POL Tee	3/4" FNPT	9-13	11
MEGR-1632T-JFFXA <sup>(2)</sup>	Full Size	900,000	F. POL Tee	3/4" FNPT	9-13	11
(1) Based on 30 PSIG inlet pressure and 20% droop						
(2) Indicates regulator vents opposite pressure tap ports						
Accessories						
Part No.	Description					
ME2130	First Stage Pipe Away Elbow 1/4" M. Inverted Flare x 1/4" F. Inverted Flare					

(1) Based on 30 PSIG inlet pressure and 20% droop  
(2) Indicates regulator vents opposite pressure tap ports



# DOMESTIC - INTEGRAL TWO-STAGE

These integral two-stage regulators combine the first and second stage regulator set-up into one convenient unit converting full tank pressure to 11" WC. All MEC integral two-stage domestic regulators are gray indicating low outlet pressure. Integral two-stage regulators are recommended for installations with short piping distances, but provide the same advantages of two-stage regulation with a single unit. All MEC integral two-stage regulator vent have tapped ports (7/16 -24-First Stage) (3/8" FNPT Second Stage Compact / 3/4" FNPT Second Stage Full Size) and our exclusive E-Z Grip screens located over the outlet. Both the MEGR-1232 and MEGR-1632 series offer optimal relief performance that exceeds UL test requirements providing over pressure protection of no more than 2 PSI downstream pressure. MEC Excela-Flo integral two-stage domestic regulators feature a 25 year recommended replacement life, our exclusive Tri-Tap™ (Tank, 10 PSI, 11" WC) pressure port system and tear away leak check adhesive sticker.

## SPECIFICATIONS

- Type:** Integral Two-Stage
- Max. Inlet Pressure:** 250 PSIG
- Exterior Finish:** Gray Powder Coat
- Interior Finish:** Gray Powder Coat
- Orifice Size:** .170" (Compact) & .219" (Full)
- Seat Material:** Fluorocarbon (FKM)
- Diaphragm:** Fabric Reinforced NBR/Molded Lip O-Ring Bonnet Body Seal
- Relief Type:** Internal Relief - Spring Loaded
- Bonnet / Body Material:** Die Cast Aluminum
- Listings:**  / UL 144
- Mounting Holes:** Standard 3-1/2" Center
- Pressure Taps:** #54 Orifice, 1/8" FNPT, Plugged (3)
- Relief Travel Stop:** Molded in Adjustment Cap - Gray (Compact), Black (Full Size)



**MEGR-1232 Compact Series:** Offers a compact integral two-stage regulator design perfect for lower BTU applications and confined spaces. They feature an adjustment range from 8-14" WC (factory set @ 11" WC). Stainless steel integral components, fluorocarbon (FKM) seat discs, molded lip fabric reinforced diaphragms, and large precision machined aluminum orifices providing superior downstream regulation and maximum corrosion resistance against weather or contaminated gas. Compact series regulators feature 3/8" FNPT drip lip vent openings.



**MEGR-1632 Full Size Series:** Offers all of the same features as the compact MEGR-1232 series in a full size high capacity version. The full size MEGR-1632 diaphragm provides superior downstream regulation, has heavy duty wrench flats and a large 3/4" FNPT tapped drip lip vent to help prevent relief vent blockage.



Part No.	Type	Capacity in BTU/H LPG <sup>(1)</sup>	Inlet	Outlet	Vent Port	Outlet Adj. Range ("WC)	Outlet Set Point ("WC)
MEGR-1232-BBF	Compact	450,000	1/4" FNPT	1/2" FNPT	3/8" FNPT	9.5-13	11
MEGR-1232-BBFXA <sup>(2)</sup>	Compact	450,000	1/4" FNPT	1/2" FNPT	3/8" FNPT	9.5-13	11
MEGR-1232-HBF	Compact	450,000	F. POL	1/2" FNPT	3/8" FNPT	9.5-13	11
MEGR-1232-HBFXA <sup>(2)</sup>	Compact	450,000	F. POL	1/2" FNPT	3/8" FNPT	9.5-13	11
MEGR-1632-BCF	Full Size	700,000	1/4" FNPT	1/2" FNPT	3/4" FNPT	9-13	11
MEGR-1632BCFXA <sup>(2)</sup>	Full Size	700,000	1/4" FNPT	1/2" FNPT	3/4" FNPT	9-13	11
MEGR-1632-CFF	Full Size	950,000	1/4" FNPT	3/4" FNPT	3/4" FNPT	9-13	11
MEGR-1632-CFFXA <sup>(2)</sup>	Full Size	950,000	1/4" FNPT	3/4" FNPT	3/4" FNPT	9-13	11
MEGR-1632-HCF	Full Size	700,000	F. POL	1/2" FNPT	3/4" FNPT	9-13	11
MEGR-1632-HCFXA <sup>(2)</sup>	Full Size	700,000	F. POL	1/2" FNPT	3/4" FNPT	9-13	11
MEGR-1632-JFF	Full Size	900,000	F. POL	3/4" FNPT	3/4" FNPT	9-13	11
MEGR-1632-JFFXA <sup>(2)</sup>	Full Size	900,000	F. POL	3/4" FNPT	3/4" FNPT	9-13	11

### Accessories

Part No.	Description
ME2130	First Stage Pipe Away Elbow 1/4" M. Inverted Flare x 1/4" F. Inverted Flare

(1) Based on 30 PSIG inlet pressure and 20% droop  
 (2) Indicates regulator vents opposite pressure tap ports

# DOMESTIC - INTEGRAL TWO STAGE

## 2 PSI OUTLET PRESSURE

MEC **Excelsa-Flo** integral two-stage regulators combine the first and second stage regulator set-up into one convenient unit converting tank pressure to 2 PSI. All MEC integral two-stage 2 PSI regulators are white indicating 2 PSI outlet pressure. Integral two-stage 2 PSI regulators are recommended for installations with short piping distances, but provide the same advantages of two-stage regulation with a single unit. 2 PSI service regulators are used in conjunction with an LPG line regulator either at the indoor appliance or a remote manifold distribution header inlet. All MEC integral two-stage regulator vent have tapped ports (7/16 -24 - First Stage) (3/8" FNPT or 3/4" FNPT - Second Stage) and our exclusive E-Z Grip screens located over the outlet. Both the MEGR-1232E and MEGR-1632E series offer optimal relief performance that well exceeds UL test requirements providing over pressure protection of no more than 4 PSI downstream pressure.

MEC **Excelsa-Flo** integral two-stage domestic regulators feature a 25 year recommended replacement life, our exclusive Tri-Tap™ (tank, 10 PSI, 2 PSI) pressure port system and tear away leak check adhesive sticker.

### SPECIFICATIONS

- Type:** Integral Two-Stage 2 PSI
- Max. Inlet Pressure:** 250 PSIG
- Exterior Finish:** White Powder Coat
- Interior Finish:** White Powder Coat
- Orifice Size:** .17" (Compact) & 7/32" (Full)
- Seat Material:** Fluorocarbon (FKM)
- Diaphragm:** Fabric Reinforced NBR/Molded Lip
- O-Ring Bonnet/Body Seal**
- Relief Type:** Internal Relief - Spring Loaded
- Bonnet / Body Material:** Die Cast Aluminum
- Listings:** cUL<sub>US</sub> / UL 144
- Mounting Holes:** Standard 3-1/2" Center
- Pressure Taps:** #54 Orifice 1/8" FNPT Plugged (3)
- Relief Travel Stop:** Molded in Adjustment Cap - Gray (Compact), White (Full Size)



PATENT PENDING



**MEGR-1232E Compact Series:** Offers a compact integral two-stage 2 PSI regulator design perfect for lower BTU applications and confined spaces. They feature an adjustment range from 1-2.2 PSI (factory set @ 2 PSI). Stainless steel integral components, fluorocarbon (FKM) seat discs, molded lip fabric reinforced diaphragms, and large precision machined aluminum orifices providing superior downstream regulation and maximum corrosion resistance against weather or contaminated gas.



**MEGR-1632E Full Size Series:** Offers all of the same features as the compact MEGR-1232E series in a full size high capacity version. The full size MEGR-1632E diaphragm provides superior downstream regulation, has heavy duty wrench flats and a large 3/4" FNPT tapped drip lip vent to help prevent relief vent blockage.

Part No.	Type	Capacity in BTU/H LPG <sup>(1)</sup>	Inlet	Outlet	Outlet Adj. Range (PSI)	Outlet Set Point (PSI)
MEGR-1232E-BBH	Compact	500,000	1/4" FNPT	1/2" FNPT	1-2.2	2
MEGR-1232E-BBHXA <sup>(2)</sup>	Compact	500,000	1/4" FNPT	1/2" FNPT	1-2.2	2
MEGR-1232E-HBH	Compact	500,000	F. POL	1/2" FNPT	1-2.2	2
MEGR-1232E-HBHXA <sup>(2)</sup>	Compact	500,000	F. POL	1/2" FNPT	1-2.2	2
MEGR-1632E-BCH	Full Size	850,000	1/4" FNPT	1/2" FNPT	1-2.2	2
MEGR-1632E-BCHXA <sup>(2)</sup>	Full Size	850,000	1/4" FNPT	1/2" FNPT	1-2.2	2
MEGR-1632E-CFH	Full Size	850,000	1/4" FNPT	3/4" FNPT	1-2.2	2
MEGR-1632E-CFHXA <sup>(2)</sup>	Full Size	850,000	1/4" FNPT	3/4" FNPT	1-2.2	2
MEGR-1632E-HCH	Full Size	900,000	F. POL	1/2" FNPT	1-2.2	2
MEGR-1632E-HCHXA <sup>(2)</sup>	Full Size	900,000	F. POL	1/2" FNPT	1-2.2	2
MEGR-1632E-JFH	Full Size	850,000	F. POL	3/4" FNPT	1-2.2	2
MEGR-1632E-JFHXA <sup>(2)</sup>	Full Size	850,000	F. POL	3/4" FNPT	1-2.2	2
Accessories						
Part No.	Description					
ME2130	First Stage Pipe Away Elbow 1/4" M. Inverted Flare x 1/4" F. Inverted Flare					

(1) Based on 30 PSIG inlet pressure and 20% droop  
 (2) Indicates regulator vents opposite pressure tap ports



# INTEGRAL TWO-STAGE

## 2 PSI OUTLET PRESSURE

The **MEGR-300 Compact Integral Two Stage 2 PSI Regulator** is approved for use in nearly all portable applications and light duty domestic installations. Ideally suited for installations to reduce tank pressure to a nominal 2 PSI outlet pressure. 2 PSI systems typically incorporate a line service regulator within the home that further reduces the 2 PSI system pressure to approximately 11" WC prior to the appliance. These regulators feature all zinc body construction, red powder coated bonnets (identify 2 PSI model), high and low 1/8" NPT pressure tap ports, an integral second stage drip lip vent, and optional standard or 90 degree vent locations. The MEGR-300 series compact high capacity integral two stage regulator meet UL, and NFPA requirements.

### SPECIFICATIONS

- Type:** Two Stage
- Max. Inlet Pressure:** 250 PSI
- Inlet Connection:** 1/4" FNPT
- Outlet Connection:** 3/8" FNPT
- Exterior Finish:** Red Powder Coat / Raw Zinc
- Diaphragm:** Fabric Reinforced Molded with O-Ring Bonnet / Body Seal
- Diaphragm Type:** Internal Relief - Spring Loaded
- Bonnet / Body Material:** Die Cast Zinc
- Listings:**  LISTED / UL 144
- Mounting Holes:** 3-1/2" On Center
- Pressure Taps:** 1/8" FNPT Plugged



Part No.	Description	BTU/H LPG @ 30 PSI Inlet*	Accessories
<b>MEGR-300</b>	Compact 2 Stage 2 PSI Regulator 1/4" FNPT Inlet x 3/8" FNPT Outlet	225,000	MEGR-900 (Z-Bracket)
<b>MEGR-300-90</b>	Compact 2 Stage 2 PSI Regulator 1/4" FNPT Inlet x 3/8" FNPT Outlet - 90° Vent		MEGR-861 (1st Stage Cover)
			MEGR-862 (2nd Stage Cover)

\* Setpoint: 100 PSIG Inlet @ 2 PSI Outlet Flowing @ 30 SCFH Air



# DOMESTIC - AUTOMATIC CHANGEOVER



**MEGR-175CS61222-BAF**



**MEGR-175CS61622-BCF**



**MEGR-175CS61622E-BCF**



These Two Stage Automatic Changeover regulators combine the first and second stage regulator into one unit converting full tank pressure to 11" WC. MEC **Excelsa-Flo** Automatic Changeover regulators prevent gas outages by switching supply cylinders over to the reserve cylinder automatically when the primary cylinder is near empty. When the primary cylinder is depleted causing the changeover to occur a red indicator will appear signifying the reserve cylinder is now in use and the primary cylinder can be refilled without loss of service.

## SPECIFICATIONS

- Type:** Automatic Changeover Two-Stage
- Max. Inlet Pressure:** 250 PSIG
- Exterior Finish:** Gold / Green Powder Coat
- Orifice Size:** .140" (Compact) & .219" (Full)
- Seat Material:** (NBR) 1st Stage, Fluorocarbon (FKM) 2nd Stage
- Diaphragm:** Fabric Reinforced (NBR) /  
Molded Lip O-Ring Bonnet/Body Seal
- Relief Type:** Internal Relief - Spring Loaded
- Bonnet / Body Material:** Die Cast Zinc/Plastic 1st Stage,  
Die Cast Aluminum 2nd Stage
- Listings:** cUL<sub>US</sub> / UL 144 2<sup>nd</sup> Stage
- Mounting Holes:** Standard 3-1/2" Center
- Pressure Taps:** #54 Orifice, 1/8" FNPT, Plugged (1)
- Relief Travel Stop:** Molded in Adjustment Cap -  
Gray (Compact), Black (Full Size)

**MEGR-175CS61622-BCF Series:** Offers all of the same features as the compact MEGR-175S61222 series but with a full size high capacity second stage regulator option. The full size second stage diaphragm provides superior downstream regulation and features heavy duty wrench flats and a large 3/4" FNPT tapped drip lip vent to help prevent relief vent blockage. This regulator is perfect for manifolding larger tanks together such as 420 LB cylinders.

**MEGR-175CS61222-BAF Series:** Offers a compact two stage regulator option for lower BTU applications such as mobile or seasonal homes. They feature a second stage adjustment from 8-14" WC (factory set @ 11" WC), stainless steel internal components, fluorocarbon (FKM) seat discs, molded lip fabric reinforced diaphragms, and large precision machined aluminum orifices providing superior downstream regulation and maximum resistance against weather or contaminated gas. The compact second stage features a 3/8" FNPT drip lip vent.

Part No.	Type	Primary Cylinder Capacity in BTU/H LPG <sup>(1)</sup>	Auxiliary Cylinder Capacity in BTU/H LPG <sup>(1)</sup>	Inlet	Outlet	Outlet Adj. Range ("WC)	Outlet Set Point ("WC)
MEGR-175CS61222-BAF	Compact	400,000	340,000	1/4" IF (2)	1/2" FNPT	9.5-13	11
MEGR-175CS61622-BCF	Full Size	650,000	570,000	1/4" IF (2)	1/2" FNPT	9-13	11
MEGR-175CS61622E-BCH	Full Size	625,000	525,000	1/4" IF (2)	1/2" FNPT	1.0-2.2 PSI	2 PSI

(1) Based on 30 PSIG inlet pressure and 20% droop





# AUTOMATIC CHANGEOVER REGULATOR



The **MEGR-253 Series** Automatic Changeover regulators automatically redirect LP gas vapor flow from an empty service cylinder to a reserve cylinder, without interruption of service. It features an easy to read green indicator which changes to red when the service cylinder needs to be refilled.

As a two-stage high-pressure regulator, the **MEGR-253H** reduces container pressure to approximately 10 to 15 PSIG and then the second stage completes the process by reducing inlet pressure down to 11 inches of water column (0.4 PSIG) outlet pressure.

The **MEGR-253L** is specifically intended for application with low BTU demands but still require two stage regulation. The Model MEGR-253L is ideally suited for RV, manufactured homes, cabins or other applications with a single appliance or low BTU multiple appliance applications while still permitting maximum range of output pressure adjustment.

The MEGR-253, MEGR-293H and MEGR-253L Series regulators meet UL, RVIA and NFPA requirements.

## SPECIFICATIONS

- Type:** Two Stage
- Max Inlet Pressure:** 250 PSI
- Inlet Connection:** 1/4" Female Inverted Flare (2)
- Outlet Connection:** 3/8" FNPT (1)
- Exterior Finish:** Raw Zinc (MEGR-253), Powder Coat (MEGR-253H)
- Diaphragm:** Fabric Reinforced Molded with O-Ring Bonnet / Body Seal
- Relief Type:** Internal Relief - Spring Loaded
- Bonnet / Body Material:** Die Cast Zinc
- Listings:** LISTED / UL 144
- Mounting Holes:** 3-1/2" On Center
- Pressure Taps:** 1/8" FNPT, Plugged (1)



**MEGR-900**  
Z-Mounting Bracket



**MEGR-RVB**  
L-Mounting Bracket



**MEGR-862**  
Second Stage Cover

Part No.	Description	Primary Cylinder BTU/Hr.**	Reserve Cylinder BTU/Hr.**	Covers	Mounting Bracket
<b>MEGR-253*</b>	2 Stage Auto Changeover Regulator 1/4" Inv. Flare x 3/8" FPT	225,000	150,000	MEGR-862	MEGR-900 or MEGR-RVB
<b>MEGR-253H*</b>	<i>High Capacity</i> 2 Stage Auto Changeover Regulator 1/4" Inv. Flare x 3/8" FPT	350,000	200,000		
<b>MEGR-253L*</b>	<i>Low Capacity</i> 2 Stage Auto Changeover Regulator 1/4" Inv. Flare x 3/8" FPT	150,000	100,000		

\* Packaged option consists of a plastic clamshell with barcode. To order add "P" at the end of the part number i.e. MEGR-253P

\*\* BTU/H Capacity @ 20% Droop

Note: MEGR-253 and MEGR-253H set point: 100 PSIG Inlet @ 11" WC outlet flowing @ 30 SCFH Air

MEGR-253L set point: 100 PSIG Inlet @ 11" WC outlet flowing @ 10 SCFH Air



# COMPACT INTEGRAL TWO STAGE

**MEGR-291**  
Compact Regulator  
with Drip Lip Vent



**MEGR-295**  
MEGR-291 with Hard-Nose  
Excess Flow POL



**MEGR-291H**  
High Capacity Regulator  
with Drip Lip Vent



**MEGR-298L**  
Low Capacity Regulator  
with Side Vent



## SPECIFICATIONS

- Type:** Two Stage
- Max. Inlet Pressure:** 250 PSI
- Inlet Connection:** 1/4" FNPT
- Outlet Connection:** 3/8" FNPT
- Exterior Finish:** Raw Zinc / Powder Coated
- Diaphragm:** Fabric Reinforced Molded with O-Ring Bonnet / Body Seal
- Diaphragm Type:** Internal Relief - Spring Loaded
- Bonnet/ Body Material:** Die Cast Zinc
- Listings:** LISTED / UL 144
- Mounting Holes:** 3-1/2" On Center
- Pressure Taps:** 1/8" FNPT Plugged

The MEC **MEGR-291** two-stage regulators are approved for use in nearly all portable applications and outdoor cooking appliances utilizing low pressure. They feature all zinc body construction, high and low 1/8" NPT pressure tap ports, an integral second stage drip lip vent and optional standard or 90 degree vent locations.

The **MEGR-291H** is ideally suited for high demand RV, outdoor appliances, cabins, seasonal homes, gas fire places, water heaters, ranges or other moderate to low demand domestic home installations. (Green bonnet identifies high capacity model).

The **MEGR-291L** is specifically intended for application with low BTU demands but still require two stage regulation. The Model MEGR-291L is ideally suited for RV, manufactured homes, cabins or other applications with one appliance or low BTU multiple appliance applications while still permitting maximum range of output pressure adjustment.

The MEGR-291 Series regulators meet UL, RVIA and NFPA requirements.

Part No.	Description	BTU/H LPG @ 30 PSI Inlet*	Accessories
MEGR-291	Compact 2 Stage Regulator 1/4" FNPT Inlet x 3/8" FNPT Outlet	175,000	
MEGR-291H	Compact 2 Stage <i>High Capacity</i> Regulator 1/4" FNPT Inlet x 3/8" FNPT Outlet	225,000	MEGR-RVB (L- Bracket)
MEGR-291L	Compact 2 Stage <i>Low Capacity</i> Regulator 1/4" FNPT Inlet x 3/8" FNPT Outlet	120,000	
MEGR-298	Compact 2 Stage Regulator 1/4" FNPT Inlet x 3/8" FNPT Outlet - 90° Vent	175,000	MEGR-900 (Z-Bracket)
MEGR-298H	Compact 2 Stage <i>High Capacity</i> Regulator 1/4" FNPT Inlet x 3/8" FNPT Outlet - 90° Vent	225,000	
MEGR-298L	Compact 2 Stage <i>Low Capacity</i> Regulator 1/4" FNPT Inlet x 3/8" FNPT Outlet - 90° Vent	120,000	
MEGR-295	Compact 2 Stage Regulator HN Excess Flow POL Inlet x 3/8" FNPT Outlet - 90° Vent	175,000	MEGR-861 (1st Stage Cover)
MEGR-295H	Compact 2 Stage <i>High Capacity</i> Regulator HN Excess Flow POL Inlet x 3/8" FNPT Outlet - 90° Vent	225,000	
MEGR-291-20681	Compact 2 Stage Regulator Green Type I QCC Inlet x 3/8" FNPT Outlet	175,000	
MEGR-291H-20681	Compact 2 Stage <i>High Capacity</i> Regulator Green Type I QCC Inlet x 3/8" FNPT Outlet	225,000	MEGR-862 (2nd Stage Cover)
MEGR-298-20681	Compact 2 Stage Regulator Green Type I QCC Inlet x 3/8" FNPT Outlet - 90° Vent	175,000	
MEGR-298H-20681	Compact 2 Stage <i>High Capacity</i> Regulator Green Type I QCC Inlet x 3/8" FNPT Outlet - 90° Vent	225,000	

MEGR-291 and MEGR-291H setpoint: 100 PSIG Inlet @ 11" WC Outlet Flowing @ 30 SCFH Air  
 \* BTU/H Capacity @ 20% Droop



**MEGR-RVB**  
L-Mounting Bracket



**MEGR-861**  
First Stage Regulator



**MEGR-862**  
Second Stage Cover



# LOW PRESSURE - SINGLE STAGE

The MEGR-230 single-stage regulators are approved for use in small portable applications and outdoor cooking appliances utilizing low pressure.

**NOTE:** Single-stage regulators are not approved for RV use per NFPA 1192.

## SPECIFICATIONS

- Type:** Single Stage
- Orifice Diameter:** 0.059 Diameter
- BTU Capacity:** 140,000 BTU (based on 25 PSI inlet @ 9 W.C. delivery pressure)
- Max. Inlet Pressure:** 250 PSI
- Inlet Connection:** 1/4" FNPT
- Outlet Connection:** 3/8" FNPT
- Exterior Finish:** Green Wet Coat
- Diaphragm Type:** Molded with O-Ring Bonnet / Body Seal
- Bonnet/Body Material:** Die Cast Aluminum
- Listings:**  LISTED / UL 144
- Mounting Holes:** 3-1/2" On Center

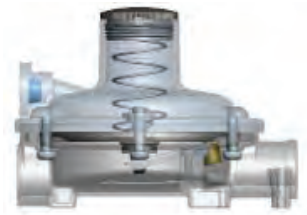

Part No.	Description	Vent Orientation
MEGR-218	Single Stage Regulator - SN FF POL w/ Plastic Handwheel x 3/8" FNPT - 90° Vent	90°
MEGR-230	Single Stage Regulator - 1/4" FNPT Inlet X 3/8" FNPT Outlet	Over Outlet
MEGR-230-9	Single Stage Regulator - SN .9 GPM Excess Flow POL Inlet x 3/8" FNPT Outlet	Over Outlet
MEGR-230-90	Single Stage Regulator - 1/4" FNPT Inlet X 3/8" FNPT Outlet - 90° Vent	90°
MEGR-230-1618	Single Stage Regulator - Black F. QCC Inlet x 3/8" FNPT Outlet - 90° Vent	90°
MEGR-230-1326	Single Stage Regulator - Black F. QCC Inlet (100,000 BTU/ H) x 3/8" FNPT Outlet	Over Outlet
MEGR-231	Single Stage Regulator - Hardnose FF POL Inlet x 3/8" FNPT Outlet - 90° Vent	90°



# SINGLE STAGE PRESSURE REDUCING

The MEGR-1912 Series UL Listed regulators are direct-operated, spring-loaded models designed for use in a variety of service and industrial applications. These regulators have limited-capacity internal relief across the diaphragm to help minimize over pressurization.

The MEGR-1912 Series with capacity ratings of less than 320,000 BTU/hr (129 scfh), are often used on small portable outdoor appliances.

Underwriters Laboratories requires horizontally mounted regulators to be installed with vent opening protection to prevent blockage by freezing rain.

## SPECIFICATIONS

- Type:** Single Stage
- Max. Inlet Pressure:** 250 PSI
- Vent Screen:** Monel
- Gasket:** CGR 2750
- Relief Valve:** Brass and Zinc
- Control and Relief Valve Spring:** Plated Steel
- Diaphragm Assembly:** Nitrile (NBR) with Zinc disk
- Spring Case:** Die Cast - Zinc
- Spring Seat:** Plated Steel
- Diaphragm Plate:** Plated Steel
- Body Material / Lower Casting:** Die Cast - Zinc
- Temperature Range:** -20° to 170° F
- Approximate Weight:** 1.3 lbs.
- Listings:** UL LISTED / UL 144



MEGR-1912  
SERIES 

Part No.	Inlet x Outlet Connection Style	Orifice Sizes, Inches (mm)	Outlet Pressure Setting	Outlet Pressure Ranges, Inches W.C. (mbar)	Vent Orientation	BTU/H LPG @ 100 PSI Inlet
MEGR-1912/101	1/4" x 3/8" FNPT	0.073 (1,8)	11-inches w.c. (27 mbar)	9.25 to 13 (23 to 32)	Over Outlet	242,953
MEGR-1912/104	1/4" x 1/4" FNPT	0.073 (1,8)	11-inches w.c. (27 mbar)	9.25 to 13 (23 to 32)	Over Outlet	242,953
MEGR-1912/109	1/4" x 3/8" FNPT	0.073 (1,8)	7-inches w.c. (17 mbar)	5 to 10 (12 to 25)	Over Outlet	242,953
MEGR-1912/197	1/4" x 3/8" FNPT	0.094 (2,4)	20-inches w.c. (50 mbar)	12 to 24 (30 to 60)	Over Outlet	313,488
MEGR-1912H/108	1/4" x 3/8" FNPT	0.094 (2,4)	1.5 PSI (103 mbar)	0.5 to 2.7 psi (34 to 186 mbar)	Over Outlet	297,814
MEGR-1912H/520	1/4" x 1/4" FNPT	0.094 (2,4)	3.5 PSI (241 mbar)	2.7 to 5 psi (186 to 345 mbar)	Over Outlet	----
MEGR-1912H/534	1/4" x 1/4" FNPT	0.073 (1,8)	1.5 PSI (103 mbar)	0.5 to 2.7 psi (34 to 186 mbar)	Over Outlet	----
MEGR-1912N/113	1/4" x 3/8" FNPT	0.073 (1,8)	5-inches w.c. (27 mbar)	3 to 7 (7 to 17)	Over Outlet	----
MEGR-1912N/194	1/4" x 1/4" FNPT	0.073 (1,8)	5-inches w.c. (27 mbar)	3 to 7 (7 to 17)	Over Outlet	----

\* Other configurations and materials available upon request



# HIGH PRESSURE REGULATORS

The **MEGR-130 series** fixed high pressure single stage regulators are designed to provide an economical solution for pounds to pounds service applications. The MEGR-130 can be used to regulate air as well as LP gas. Regulators must be installed in compliance with federal, state or local codes or laws in accordance with NFPA 58.



**MEGR-130-20**  
Pre-Set at 20 PSIG



Non-Adjustable Configurations	
Part No.	Description
MEGR-130-05	Compact High Pressure Fixed Reg 5 PSI - 1/4" FNPT Inlet/Outlet
MEGR-130-10	Compact High Pressure Fixed Reg 10 PSI - 1/4" FNPT Inlet/Outlet
MEGR-130-20	Compact High Pressure Fixed Reg 20 PSI - 1/4" FNPT Inlet/Outlet
MEGR-130-30	Compact High Pressure Fixed Reg 30 PSI - 1/4" FNPT Inlet/Outlet
MEGR-130-50	Compact High Pressure Fixed Reg 50 PSI - 1/4" FNPT Inlet/Outlet
MEGR-130-80	Compact High Pressure Fixed Reg 80 PSI - 1/4" FNPT Inlet/Outlet

## SPECIFICATIONS

**Type:** Adjustable or Fixed / PSI

**Max. Inlet Pressure:** 250 PSIG (17,2 bar)

**Inlet Connection:** 1/4" FNPT

**Outlet Connection:** 1/4" FNPT

**Orifice Diameter:** 0.0625"

**Exterior Finish:** Red Anodized

**Diaphragm:** Fabric Reinforced Buna N

**Bonnet/Body Material:** Die Cast Zinc

**BTU / H Capacity:** 1,200,000 BTU/H @ 40 PSI

**Listings:** UL LISTED / UL 144

**MEGR-350** -Single stage, adjustable high pressure regulator. The body and bonnet of both the fixed and adjustable regulators are precisely machined and feature a crimped design and fabric reinforced rubber diaphragm creating a positive seal for leak-free performance.

**MEGR-360** with the Type I (QCC) is designed specifically for appliances such as turkey fryers, fish fryers, camp stoves and torch applications that require pounds to pounds pressure instead of inches water column. These regulators will meet or exceed most requirements on a specific outlet setting (0-10 PSI) depending on the application.



**MEGR-350**  
Adjustable 0-10 PSIG



Adjustable Configurations	
Part No.	Description
MEGR-350	Compact High Press. Adjustable Reg 0-10 PSI - 1/4" FNPT Inlet/Outlet
MEGR-350-20	Compact High Press. Adjustable Reg 0-20 PSI - 1/4" FNPT Inlet/Outlet
MEGR-350-30	Compact High Press. Adjustable Reg 0-30 PSI - 1/4" FNPT Inlet/Outlet
MEGR-351	Compact High Pressure Adjustable Reg 0-10 PSI - Full Flow POL x 1/4" FNPT
MEGR-360	Compact High Pressure Adjustable Reg 0-10 PSI - Black F. QCC x 1/4" FNPT

NOTE: Not designed to provide 100% shutoff of flow



# HIGH PRESSURE REGULATORS

The **MEGR-6120 Series** are UL listed high-pressure regulators that meet a variety of applications for liquid or vapor service. The compact body design makes these regulators particularly useful in installations with space limitations. The basic MEGR-6120 Series regulators come equipped with a handwheel adjustment. The non-adjustable **ME6121 Series** provides a tamper-resistant spring case and one of seven fixed set points: 5, 10, 20, 30, 40, 50, or 60 PSI.

The MEGR-6120 & MEGR-6121 Series are UL listed as high pressure, non-relief regulators. Both MEGR-6120 & MEGR-6121 Series regulators contain brass materials that are **not** compatible with anhydrous ammonia service.

## SPECIFICATIONS

- Type:** Adjustable or Fixed / PSI
- Max. Inlet Pressure:** 250 PSI (17, 2 bar)
- Inlet Connection:** 1/4" FNPT
- Outlet Connection:** 1/4" FNPT
- Gauge Port:** 1/4" FNPT
- Exterior Finish:** Red Wet Coat
- Diaphragm:** Fabric Reinforced Buna N
- Body / Bonnet Material:** Die Cast Aluminum
- Liquid Capacity:** 3-5 GPH
- Listings:** UL LISTED / UL 144

MEGR-6120 Series 



CAPACITIES: BTU/H LPG (VAPOR)		
Outlet Set Point	Inlet Pressure	BTU / HR
15 PSI	50 PSI	850,000
15 PSI	100 PSI	1,700,000
15 PSI	150 PSI	2,500,000
20 PSI	50 PSI	900,000
20 PSI	100 PSI	1,800,000
40 PSI	100 PSI	1,500,000
40 PSI	150 PSI	2,000,000
50 PSI	100 PSI	1,300,000
50 PSI	150 PSI	1,800,000
50 PSI	200 PSI	2,300,000

\*Approximate BTU/H vapor capacities taking 10-20% droop into consideration

Note: Side Outlet Connection Style (Plugged): 1/4" MNPT, pressure gauge (MEJ500 Series) can be installed

Adjustable Configurations	
Part No.	Description
MEGR-6120-30	High Pressure Adjustable Reg 1-30 PSI - 1/4" FNPT Inlet/Outlet
MEGR-6120-60	High Pressure Adjustable Reg 1-60 PSI - 1/4" FNPT Inlet/Outlet
MEGR-6120-100	High Pressure Adjustable Reg 1-100 PSI - 1/4" FNPT Inlet/Outlet

MEGR-6121 Series 



Non-Adjustable Configurations	
Part No.	Description
MEGR-6121-05	High Pressure Fixed Reg 5PSI - 1/4" FNPT Inlet/Outlet
MEGR-6121-10	High Pressure Fixed Reg 10PSI - 1/4" FNPT Inlet/Outlet
MEGR-6121-20	High Pressure Fixed Reg 20PSI - 1/4" FNPT Inlet/Outlet
MEGR-6121-30	High Pressure Fixed Reg 30PSI - 1/4" FNPT Inlet/Outlet
MEGR-6121-40	High Pressure Fixed Reg 40PSI - 1/4" FNPT Inlet/Outlet
MEGR-6121-50	High Pressure Fixed Reg 50PSI - 1/4" FNPT Inlet/Outlet
MEGR-6121-60	High Pressure Fixed Reg 60PSI - 1/4" FNPT Inlet/Outlet



# HIGH PRESSURE REGULATORS

The MEGR-164 Series adjustable high-pressure regulators offer a wide selection of available pressure ranges. High pressure regulators are typically used to reduce tank pressure to an intermediate pressure for use by another regulator. They may be used as high pressure regulators on distribution systems when used in conjunction with first-stage downstream regulators.

When equipped with an integral relief valve (MEGR-164SR Series), the regulator may be used as a final-stage regulator on high pressure systems. It may also be used as a first-stage regulator when set at 10 PSIG (0,69 bar) or less. The 1/4"-inch FNPT tapped side outlet can be used to install a pressure gauge or a hydrostatic relief valve. This series contains brass materials that are **not** compatible with anhydrous ammonia service.

## SPECIFICATIONS

- Type:** Adjustable/ PSI
- Max. Inlet Pressure:** 250 PSI
- Inlet Connection:** 1/2" FNPT or 3/4" FNPT
- Outlet Connection:** 1/2" FNPT or 3/4" FNPT
- Exterior Finish:** Gray Urethane
- Regulator Spring:** Steel
- Stem Guide/Disk Holder:** Stainless Steel
- Diaphragm:** Fabric Reinforced Nitrile (NBR)
- Bonnet/Body Material:** Cast Aluminum
- Vent:** Non-Relieving
- Operating Temperature Range:** -40° to 200° F
- Listings:** UL LISTED / UL 252



MEGR-164 Series



Part No.	Description	Outlet Pressure Setting, PSIG	Outlet Adjustment Range, PSIG	BTU/H * LPG @ 60 PSI Inlet	BTU/H * LPG @ 100 PSI Inlet
MEGR-164/33	1/2" FNPT x 1/2" FNPT Adjustable High Pressure Regulator	10	0-30	6,098,000	6,800,000
MEGR-164/35		20	0-30	6,400,000	8,335,000
MEGR-164/36		40	0-60	6,100,000	9,145,000
MEGR-164/222		50	0-125	4,900,000	7,225,000
MEGR-164SR/21	1/2" FNPT x 1/2" FNPT Adjustable High Pressure Regulator w/ Internal Relief Valve	10	0-15	4,675,000	7,825,000
MEGR-164SR/22		15	0-30	3,050,000	4,125,000
MEGR-164SR/23		20	0-30	3,405,000	4,755,000
MEGR-164-6/33	3/4" FNPT x 3/4" FNPT Adjustable High Pressure Regulator	10	0-30	9,150,000	10,875,000
MEGR-164-6/35		20	0-30	10,105,000	12,400,000
MEGR-164-6/36		40	0-60	9,960,000	13,415,000
MEGR-164-6/222		50	35-100	4,575,000	11,890,000

Note: 1" model also available (MEGR-164-8). Please contact factory for more information.

\* BTU/H Capacity @ 20% Droop

RECOMMENDED TO USE WITH EXTERNAL PRESSURE RELIEF DEVICE SUCH AS MEGR-1290 SERIES



# HIGH PRESSURE REGULATORS

The MEGR-11301F is a reliable and accurate regulator making it ideal for numerous high pressure applications. This multi-purpose regulator can be used as a pilot supply or pressure-loading regulator where high pressure operating medium must be reduced for use by gas regulator pilots or pressure-loaded regulators. Its rugged design and multiple outlet ports offer versatility for a wide variety of applications.

## SPECIFICATIONS

- Type:** Adjustable / PSI
- Max. Inlet Pressure:** 5500 PSIG
- Inlet Connection:** 1/4" FNPT (1 Port)
- Outlet Connection:** 1/4" FNPT (3 Ports)
- Exterior Finish:** Brass
- Bonnet / Body Material:** Brass
- Bottom Cap and Spring Case:** Brass
- Gasket:** Nitrile (NBR)
- Valve Spring:** Stainless Steel
- Diaphragm:** Stainless Steel
- Valve Disks:** Nylon
- Vent:** 4 Holes (5/32" each)
- Temp. Range:** -40° F. / 225° F.



Part No.	Description	Inlet (1 Port)/ Outlet (3 Ports)	Outlet Pressure Range (PSIG)
MEGR-11301F	High Pressure Regulator	1/4" FNPT	0-120

# LIQUID BACKPRESSURE/RELIEF VALVE

The MEGR-198H Series, liquid service valves are direct-operated relief valves for use on relief and backpressure applications involving large LP-Gas pumping systems and vaporizers. Internal pressure registration eliminates the need for a control line.

## SPECIFICATIONS

- Type:** Adjustable / PSI
- Orifice Material:** Stainless Steel
- Max. Inlet Pressure:** 250 PSIG
- Regulator Spring:** Plated Steel
- O-Ring Seat:** Nitrile (NBR)
- Exterior Finish:** Gray Powder Coat
- Diaphragm:** Neoprene
- Body Material / Spring Case:** Iron

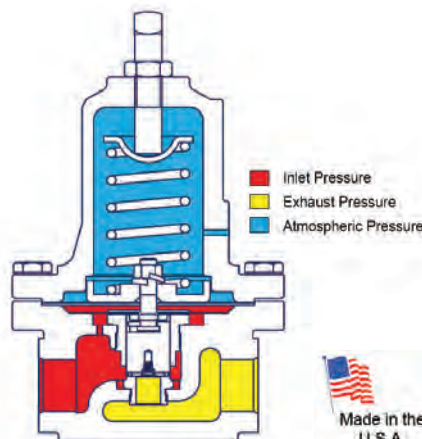

Part No.	Inlet/Outlet Size	Relief Pressure Setting PSIG (BAR)	Outlet Range PSIG (BAR)	Relief Capabilities GPM/LPG	
				10 PSI Over Set P point	50 PSI Over Set Point
MEGR-198H-22	3/4" FNPT	100 (6.9)	70 to 140 (4.8 to 9.7)	49	93
MEGR-198H-30	1" FNPT	100 (6.9)	70 to 140 (4.8 to 9.7)	49	93
MEGR-198H-31	1" FNPT	175	130-200	52	109





# COMMERCIAL/INDUSTRIAL

## FIRST STAGE / HIGH PRESSURE

The **MEGR-1627 Series** commercial/industrial regulator is a large capacity, high pressure unit for use in conjunction with MEGR-CS1200 or MEGR-S1202 Series regulators. It can also be used on final-stage (PSI to PSI) service. The diaphragm case and/or regulator body on the MEGR-1627 Series can be rotated in any of four positions to allow installation in locations with limited space. Available with a monitor or integral relief valve. The MEGR-1627 Series is perfectly suited for jurisdictional systems, grain dryers, direct fired vaporizers or other high capacity service applications.

The **MEGR-1630 Series** First Stage / Industrial regulators are large capacity, high pressure units for use in conjunction with MEGR-S1202 Series regulators. They can also be used on final stage (pounds-to-pounds) service. These regulators are best suited for industrial applications where high flow capacity is required.

### SPECIFICATIONS

- Type:** Adjustable / PSI
- Orifice Diameter:** 3/8" or 1/2"
- Orifice Material:** Aluminum
- Max. Inlet Pressure:** 250 PSI
- Regulator Spring:** Steel
- Stem Guide / Disk Holder:** Stainless Steel
- Valve Stem:** Steel
- Exterior Finish:** Grey Powder Coat
- Diaphragm:** Fabric Reinforced Nitrile (NBR)
- Bonnet Cap & Housing/Body Material:** Cast Aluminum/ Iron
- Temp. Range:** -20° F. / 180° F.
- Listings:** UL LISTED / UL 144

MEGR-1627 Series



MEGR-1630 Series



Part No.	Description	Inlet/Outlet	Orifice	PSIG Outlet Set Point	PSIG Outlet Range	Monitor	BTU/H LPG @ 100 PSI Inlet	BTU/H LPG @ 20 PSI Inlet
MEGR-1627/497	First Stage High Pressure Regulator	1" FNPT	1/2"	20	15-40	No	36,600,000	6,050,000
MEGR-1627/576		2" FNPT	1/2"	10	5-20	No	45,000,000	6,003,000
MEGR-1627/5810		3/4" FNPT	3/8"	10	5-20	No	11,700,000	4,700,000
MEGR-1627/6210		3/4" FNPT	1/2"	10	5-20	No	12,400,000	6,700,000
MEGR-1627/7710		1" FNPT	1/2"	10	5-20	No	25,100,000	6,900,000
MEGR-1627M/267		2" FNPT	1/2"	10	5-20	Yes	36,100,000	6,003,000
MEGR-1627M/471		1" FNPT	1/2"	10	5-20	Yes	25,100,000	6,900,000
MEGR-1627R/113		3/4" FNPT	3/8"	10	5-20	Token Relief	9,800,000	4,200,000
MEGR-1627V/7710*		1" FNPT	1/2"	10	5-20	No	25,100,000	6,900,000

\* Viton® construction

Part No.	Description	Inlet/Outlet	Orifice	PSIG Outlet Set Point	Outlet PSIG Range	*SCFH/HR LPG	BTU/H LPG @ 100 PSI Inlet	BTU/H LPG @ 20 PSI Inlet
MEGR-1630-104/78	First Stage Regulator	2" FNPT	1/2"	10	8-20	18,900	47,000,000	7,700,000

Note: Other configurations and materials available upon request.



# COMMERCIAL/INDUSTRIAL

## SECOND STAGE / LOW PRESSURE

The **MEGR-S1202/MEGR-CS1200** Series commercial/industrial regulators are large capacity, low pressure second stage units for installation at schools, bakeries, and similar applications. They contain a limited capacity internal relief valve and can be used in conjunction with either MEGR-1627 Series or MEGR-1630 Series high-pressure regulators.

For high capacity installations, the MEGR-1289H Series relief valve is required to be installed in the downstream system.

**MEGR-1HSRL Series:** Offers a full size high capacity light commercial type regulator with an adjustment range from 6-14" WC (factory set @ 11" WC), a heavy duty cast iron body with a universal body to bonnet union for fast relocation of inlet to outlet vent location. These light commercial second stage regulators are used to reduce outlet pressures from first stage regulators (normally 10 PSI) to 11" WC.

### SPECIFICATIONS

- Type:** Adjustable / Inches WC or PSI
- Orifice Diameter:** 3/8", 5/16", 1/2" or 1"
- Max. Inlet Pressure:** 25 PSIG
- Body Material:** Cast Iron
- Regulator Spring:** Music Wire
- Spring Case/ Stem Guide/ Disk Holder:** Aluminum
- Disk/ Diaphragm and O-Ring:** Fabric Reinforced Nitrile (NBR)
- Closing Cap Gasket:** Neoprene



Part No.	Description	Inlet/Outlet Connection Style	Orifice	Outlet Pressure Range	Outlet Pressure Setting	Maximum Operating Inlet Pressure	BTU/H LPG @ 25 PSI Inlet	BTU/H LPG @ 10 PSI Inlet
MEGR-1HSRL-BFC	Second Stage Low Pressure Regulator	3/4" FNPT	3/8"	6-14" WC	11" WC	40 PSIG	—	2,000,000
MEGR-1HSRL-CFC		1" FNPT	3/8"	6-14" WC	11" WC	40 PSIG	—	2,500,000
MEGR-CS1200IR6EC1		3/4" FNPT	1/2"	6-14" WC	11" WC	25 PSIG	2,100,000	1,600,000
MEGR-CS1200IR6EC3		1" FNPT	1/2"	6-14" WC	11" WC		2,500,000	1,900,000
MEGR-CS1200IR6EC6		1-1/4" FNPT	1/2"	6-14" WC	11" WC		3,100,000	2,800,000
MEGR-CS1200IR7EC1		3/4" FNPT	5/16"	6-14" WC	7" WC		*1,250,000	*985,000
MEGR-CS1200IR7EC3		1" FNPT	5/16"	0.5-3 PSI	7" WC		*1,620,000	*1,525,000
MEGR-S1202G-BNC		1-1/2" FNPT	1"	9 - 18" WC	11" WC		14,700,000	10,800,000
MEGR-S1202G-CNC		2" FNPT	1"	9 - 18" WC	11" WC		30,000,000	23,000,000
MEGR-S1202H-CNK		2" FNPT	1"	1.5-3.25 PSI	2 PSI		22,200,000	10,300,000

Note: Other configurations and materials available upon request.  
WC = Water Column

\* Flow Rates listed in BTU Natural Gas



# COMMERCIAL/INDUSTRIAL

## SECOND STAGE

The MEGR-1133 series pressure regulator is a manual, direct acting, self-operating, spring loaded, adjustable regulator. It is used in applications where pressure reduction is required. The regulator will reduce the risk of “shock” from abrupt changes of downstream conditions. This can help prevent safety equipment from shutting an operation down. The MEGR-1133 is equipped with external pressure registration; an external control line is needed to connect the output pressure port with the diaphragm chamber. The MEGR-1133 utilizes a balance diaphragm to reduce the effects of supply pressure changes on the output pressure. The external pressure registration of the standard MEGR-1133 also allows it to be used as a monitor regulator.



### SPECIFICATIONS

- Maximum Operating Inlet:** 60 PSIG
- Maximum Emergency Inlet:** 125 PSIG
- Maximum Operating Outlet:**
  - MEGR-1133L - 2 PSIG
  - MEGR-1133H - 10 PSIG
- End Connections:** 2" NPT
- Temperature Range:** -40°F to 200°F



### MATERIALS OF CONSTRUCTION

- Body:** Iron
- Bonnet:** Aluminum
- Orifice:** Aluminum
- Regulator Spring:** Steel
- Stem Guide/Disk Holder:** Aluminum
- Valve Stem:** Aluminum
- Diaphragm:** Fabric Reinforced Nitrile (NBR)
- Exterior Finish:** Gray Powder Coat

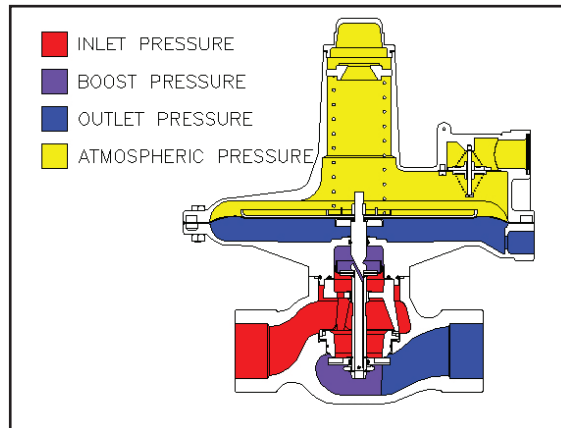

Part No.	Description	Inlet/Outlet	Orifice	Range of Adjustment	Outlet Set Point	BTU/H LPG @ 10 PSI Inlet	BTU/H LPG @ 20 PSI Inlet
MEGR-1133H-2	Second Stage Regulator	2" FNPT	2"	2-5 PSI	2 PSI	27,405,000	52,700,000
MEGR-1133H-3	Second Stage Regulator	2" FNPT	2"	5-10 PSI	5 PSI	22,300,000	41,600,000
MEGR-1133L-4	Second Stage Regulator	2" FNPT	2"	8.5"-18" WC	14" WC	45,600,000	77,100,000
MEGR-1133L-6	Second Stage Regulator	2" FNPT	2"	.75-2 PSI	2 PSI	46,700,000	77,100,000

Note: Other configurations available upon request



# VAPOR BACKPRESSURE / RELIEF VALVES

Available in settings ranging between 1 to 75 PSIG for the 3/4" & 1" models and 7"WC to 15 PSI for the 2" models. The MEGR-1289H Series relief valve is a throttling relief valve used downstream of pressure regulators to protect the downstream system from overpressure. A smooth throttling action minimizes pressure surges in the system during emergency operation.

This unit features a pilot tube booster to achieve the highest possible relief capacity with a minimum buildup of system pressure.

The MEGR-1289H Series relief valve is installed between large second stage regulators and the burner to provide high capacity relief. They are ideal for low pressure settings due to the increased sensitivity provided by the large diaphragm area. Suitable as a pressure high capacity relief device when installed between a first and second stage regulator.

## SPECIFICATIONS

**Type:** Adjustable / Inches WC or PSI

**Max. Inlet Pressure:** 100 PSIG (1" Body)  
25 PSIG (2" Body)

**Spring:** Plated Steel

**Exterior Finish:** Gray Powder Coat

**Diaphragm:** Fabric Reinforced Nitrile (NBR)

**Bonnet/Body Material:** 1" - All Aluminum  
2" - Aluminum Bonnet / Iron Body

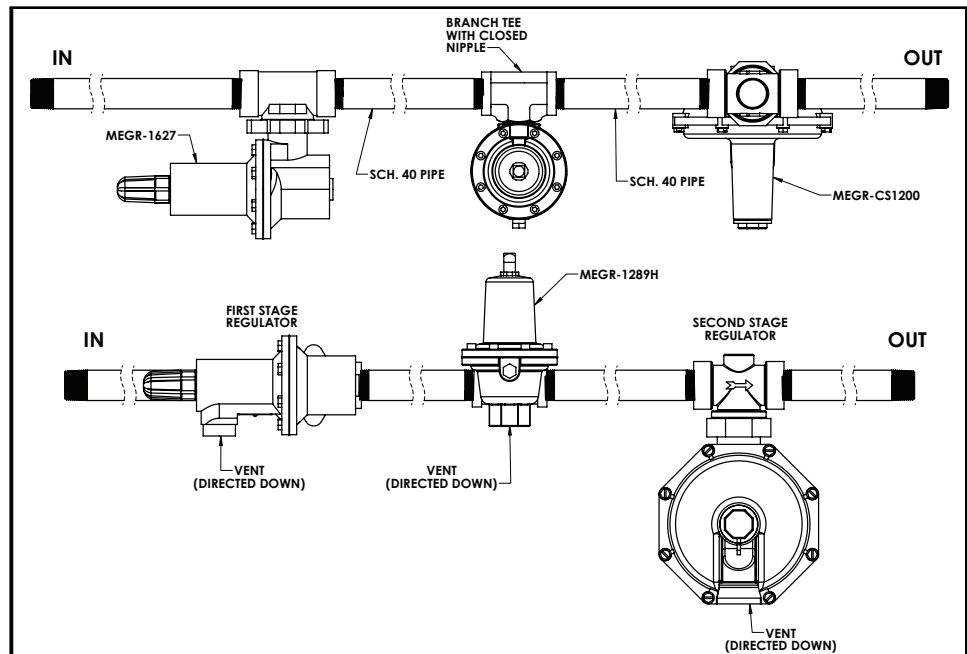

Part No.	Description	Inlet/Outlet	Max. Inlet PSIG	Set Point	Set Point Range	SCFH / Propane
MEGR-1289H/1	Back Pressure Regulator/ Relief Valve	2" FNPT	25	9" WC	7-18" WC	55,000
MEGR-1289H/2	Back Pressure Regulator/ Relief Valve	2" FNPT	25	1 PSIG	.5-2.25 PSIG	55,500
MEGR-1289H/3	Back Pressure Regulator/ Relief Valve	2" FNPT	25	3 PSIG	1.75-7 PSIG	58,000
MEGR-1289H/4	Back Pressure Regulator/ Relief Valve	2" FNPT	25	6 PSIG	4-10 PSIG	58,500
MEGR-1289H/5	Back Pressure Regulator/ Relief Valve	2" FNPT	25	12 PSIG	10-15 PSIG	61,000
MEGR-1289H/41	Back Pressure Regulator/ Relief Valve	1" FNPT	100	2 PSIG	1-4.5 PSIG	45,500
MEGR-1289H/42	Back Pressure Regulator/ Relief Valve	1" FNPT	100	8 PSIG	4-15 PSIG	46,000
MEGR-1289H/43	Back Pressure Regulator/ Relief Valve	1" FNPT	100	15 PSIG	10-20 PSIG	48,000
MEGR-1289H/49	Back Pressure Regulator/ Relief Valve	1" FNPT	100	25 PSIG	15-50 PSIG	49,000
MEGR-1289HH-1	Back Pressure Regulator/ Relief Valve	1" FNPT	100	50 PSIG	45-75 PSIG	50,000
MEGR-1290H/43	Back Pressure Regulator/ Relief Valve	3/4" FNPT X 1" FNPT	100	15 PSIG	10-20 PSIG	40,000
MEGR-1290H/49	Back Pressure Regulator/ Relief Valve	3/4" FNPT X 1" FNPT	100	25 PSIG	15-50 PSIG	50,000

Note: Other configurations and materials available upon request.

# COMMERCIAL/INDUSTRIAL

## PILOT OPERATED

The MEGR-199 Series Industrial regulators are large capacity, pilot operated, low or high pressure units for use in applications with loads demanding up to 75,000,000 BTU/H capacity. These regulators are best suited for industrial applications where high flow capacity and a downstream monitor control line can be applied. The MEGR-199 series provides exceptional downstream control while operating at very high capacities with minimal droop under varying flow and inlet pressures.



MEGR-199 Series

### SPECIFICATIONS

- Type:** Adjustable/PSI/WC
- Max. Inlet Pressure:** 150-300 PSI
- Exterior Finish:** Gray Powder Coat
- Orifice Size:** 7/8" or 1-1/8"
- Orifice Material:** Stainless Steel
- Regulator Spring:** Steel
- Diaphragm Plate:** Steel
- Diaphragm:** Fabric Reinforced Nitrile (NBR)
- Body Material:** Iron
- Bonnet Cap & Bonnet:** Iron

Part No.	Description	Inlet/ Outlet	Max. Pressure	Orifice	Range of Adjustment	Outlet Set Point	BTU/H LPG @ 20 PSI Inlet
MEGR-199-501P	Pilot Operated Low Pressure Regulator	2" FNPT	150	1-1/8"	7" WC-2 PSI	1	48,825,000
MEGR-199-502P	Pilot Operated Low Pressure Regulator	2" FNPT	150	1-1/8"	1-5 PSI	5	55,125,000
MEGR-199-503P	Pilot Operated Low Pressure Regulator	2" FNPT	150	1-1/8"	2-10 PSI	10	61,425,000
MEGR-199-504P	Pilot Operated Low Pressure Regulator	2" FNPT	150	1-1/8"	5-15 PSI	15	63,000,000
MEGR-199-510P	Pilot Operated High Pressure Regulator	2" FNPT	250	7/8"	7" WC-2 PSI	1	29,295,000
MEGR-199-511P	Pilot Operated High Pressure Regulator	2" FNPT	250	7/8"	1-5 PSI	5	33,075,000
MEGR-199-512P	Pilot Operated High Pressure Regulator	2" FNPT	250	7/8"	5-15 PSI	15	37,800,000
MEGR-199-513P	Pilot Operated High Pressure Regulator	2" FNPT	250	7/8"	2-10 PSI	10	36,225,000
MEGR-199-515P	Pilot Operated High Pressure Regulator	2" FNPT	250	7/8"	10-20 PSI	20	40,950,000
MEGR-199-903P	Pilot Operated High Pressure Regulator	2" FNPT	250	7/8"	10-65 PSI	30	44,100,000
MEGR-199-502PH	Pilot Operated High Pressure Regulator	2" FNPT	300	1-1/8"	1-5 PSI	5	55,125,000
MEGR-199-503PH	Pilot Operated High Pressure Regulator	2" FNPT	300	1-1/8"	2-10 PSI	10	61,425,000
MEGR-199-504PH	Pilot Operated High Pressure Regulator	2" FNPT	300	1-1/8"	5-15 PSI	15	63,000,000
MEGR-199-505PH	Pilot Operated High Pressure Regulator	2" FNPT	300	1-1/8"	10-20 PSI	20	67,725,000
MEGR-199-901PH	Pilot Operated High Pressure Regulator	2" FNPT	300	1-1/8"	10-65 PSI	30	74,025,000
MEGR-199M-504PH	Monitor Pilot Operated High Pressure Regulator	2" FNPT	300	1-1/8"	5-15 PSI	15	42,650,000
MEGR-199M-505PH	Monitor Pilot Operated High Pressure Regulator	2" FNPT	300	1-1/8"	10-20 PSI	20	67,725,000
MEGR-199M-901PH	Monitor Pilot Operated High Pressure Regulator	2" FNPT	300	1-1/8"	10-65 PSI	30	74,025,000

(1) Capacity based on inlet pressures 20 PSIG greater than outlet pressure set point and 20% droop.



# COMMERCIAL/INDUSTRIAL REGULATOR OPTIONS

MEGR-1627 Series First Stage Regulator Options Chart					
Base	Relief/Monitor		Body Options	Orifice	Adjustment Range
P/N	Code	Description	Description	Size	Description
MEGR-1627	M	Monitor	3/4" FNPT	1/8"	5-20PSI
	R	Token Relief	1" FNPT	3/16"	15-40PSI
	-	Non-Relieving	2" FNPT	1/4"	35-80PSI
				3/8"	70-150PSI
			1/2"	140-250PSI	

MEGR-1289/1290 Series Commercial Regulator Relief Valve Options Chart				
Base	Pressure		Body Options	Adjustment Range
P/N	Code	Description	Description	Description
MEGR-1289	H	High	1" FNPT	7-18" WC*
	L	Low	2" FNPT	10-14" WC**
MEGR-1290	H	High	3/4" FNPT	.5-2.25PSI*
	L	Low	-	1.75-7PSI*
				4-10PSI*
				10-15PSI*
				1-4.5PSI**
				4-15PSI**
				10-20PSI**
			15-50PSI**	
			45-75PSI***	

\* Note - Available In 2" Body Only.  
 \*\* Note - Available in 3/4" or 1" Body Only.  
 \*\*\* Note - Available in 3/4" or 1" HH Body Only.

MEGR-CS1200 Series Second Stage Commercial Regulator P/N Configurator Chart										
Base	Sensing		Relief		Orifice		Adjustment Range		Body Options	
P/N	Code	Description	Code	Description	Code	Size	Code	Description	Code	Description
MEGR-CS1200	I	Internal	R	Internal	1	1/8"	A	4.5-7.5" WC	C1	3/4" FNPT
					2	3/16"	C	6-9.5" WC	C3	1" FNPT
					3	1/4"	E	6-14" WC	C6	1-1/4" FNPT
					5	3/8"	F	13.5-29" WC		
					6	1/2"	G	.5-2PSI		
							H	.3-3PSI		

MEGR-S1202 Series Second Stage Commercial Regulator P/N Configurator Chart									
Base	Pressure		Body Options		Orifice		Adjustment Range		
P/N	Code	Description	Code	Description	Code	Size	Code	Description	Description
MEGR-S1202	G	Low	B	1-1/2" FNPT	J	1/4"	A	3.5-6.5" WC	
	H	High	C	2" FNPT	K	3/8"	B	5-9" WC	
					L	1/2"	C	9-18" WC	
					M	3/4"	D	14-30" WC	
					N	1"	J *	1-2PSI	
					O	1-3/16"	K *	1.5-3.25PSI	
							L *	2-5PSI	
							M *	2-6PSI	
							N *	4-10PSI	

\* Note - Only Available In High Pressure Body Construction

MEGR-1133 Series Second Stage Commercial Regulator Options Chart				
Base	Pressure		Body Options	Adjustment Range
P/N	Code	Description	Description	Description
MEGR-1133	H	High	2" FNPT	2-4" WC
	L	Low		3.5-6" WC
				5-9" WC
				8.5-18" WC
				14-28" WC
				.75-2PSI
				1.5-3.25PSI*
				2-5PSI*
				5-10PSI*

\* Note - Only Available In H Body Configuration

MEGR-199 Series Pilot Operated Commercial Regulator Options Chart							
Base	Monitor		Body Options	Pressure		Orifice	Adjustment Range
P/N	Code	Description	Description	Code	Description	Size	Description
MEGR-199	M	Monitor	2" FNPT	P	250PSI	1/2"	7" WC-2PSI
	-	Standard		PH	300PSI	5/8"	1-5PSI
						3/4"	2-10PSI
						7/8"	5-15PSI
						1-1/8"	10-20PSI
							10-65PSI*

\*Note - Only Available in PH Body Configuration



# VALVE SAFETY WARNING

Marshall Excelsior Company (MEC) would like to provide you with information regarding the hazards associated with Liquefied Petroleum Gas (LPG) and anhydrous ammonia (NH<sub>3</sub>) equipment. All MEC products must be installed and maintained in accordance with NFPA 58 "Liquefied Petroleum Gas Code", NFPA 59 "Utility LP-Gas Plant Code" for LPG, and ANSI Standard K61.1 for NH<sub>3</sub>, as well as all other applicable state, federal and local requirements. In the interest of safety, all persons employed in handling LPG and NH<sub>3</sub> must be trained in proper handling and operating procedures.

MEC products are mechanical devices that are subject to wear, contaminants, corrosion, and aging of components made of materials such as rubber and metal. Over time these devices will eventually become inoperative. The safe service life of these products is affected by the environment and conditions of use that they are subjected to. MEC products have a long record of quality and service, so managers and service personnel must keep in mind the hazards that can arise from using aging devices that have outlived their safe service life.

## !!! WARNING !!!

**Contact with, or inhalation of liquid propane, anhydrous ammonia, and their vapors can cause serious injury and death! NH<sub>3</sub> and LPG must be released outdoors in air currents that will ensure dispersion to prevent exposure to people and livestock and in accordance with local regulations. LPG must be kept far enough from open flame or other sources of ignition to prevent fire or explosion! LPG vapor is heavier than air and will not disperse or evaporate rapidly if released in still air! An abundant supply of clean water must be readily available and easily accessible as a means of providing IMMEDIATE First Aid treatment for exposure to anhydrous ammonia.**

## !!! CAUTION !!!

- Always wear suitable eye protection, gloves and protective clothing when operating or servicing LPG and NH<sub>3</sub> equipment.
- Check seals, seats and Acme threads for wear and damage before use. Repair or replace all defective parts immediately.
- Always completely relieve system or line pressure prior to servicing equipment and plumbing.
- Use a suitable sealant on tapered pipe joints and always pressure test for leaks prior to returning to service.
- Always replace protective dust caps after use.
- To prevent the accidental opening of any valve, never carry or grasp a valve by its hand wheel or handle.
- To prevent accidental discharge, introducing contaminants and premature wear, never intentionally drag or drop a hose end valve.
- Use only the special wrenches designed for making 2-1/4" and 3-1/4" Acme valve connections.
- Regular inspection and maintenance is essential for continued safe operation.

There are developing trends in state legislation and proposed national legislation making the owner of products responsible for replacing products before they outlive their safe service life. LP-Gas dealers should be aware of such legislation as it affects them.

The contents of this publication are for informational purposes only. While every effort has been made to ensure accuracy, these contents are not to be construed as warranties or guarantees, expressed or implied, regarding the products or services described herein or for their use or applicability. Marshall Excelsior Co. reserves the right to modify or improve the designs or specifications of such products at any time without notice.

The MEC™ logo is the trademark of Marshall Excelsior Co.

## Hose End and Filling Valves

Follow this procedure on every filling application in order to prevent hazardous conditions:

- Check hose end valve and filler valve for foreign materials and, if present, remove with extreme care. If foreign material cannot be safely removed, do not proceed with filling and replace valve.
- Make sure the Acme connector easily spins on by hand. Never use hammers or pipe wrenches to tighten Acme connections.
- If a leak is detected when filling is started, immediately stop the operation and follow procedures to correct the leaking condition.
- Before disconnecting a filler valve, close both the filler and hose end valve tightly and vent the trapped gas by (a) using the vent on the hose end valve or (b) slightly loosening coupling nut to vent the gas before disconnecting. Loosen the filler valve very slowly. If the gas does not stop venting, then there is a leak in the filler valve or hose end valve. Do not disconnect the filling connector. Make sure you are familiar with your companies' procedure for handling this hazardous situation and follow it carefully.

## Back Checks and Valves with Back Checks

Back checks limit flow to one direction. They are not intended to be a primary shut-off. Always fully close shut-off valves equipped with back checks when not in use.

## Excess Flows and Valves with Excess Flows

Excess flows check closed when their rated flow is exceeded. Always fully open a shut-off valve with an excess flow when in use.

## Quick Acting Filling Valves

Inspect valves daily to ensure locking mechanism is working properly.



# Excelsa-Flange TURBO-FLO LE DRY BREAK TRANSFER VALVES

## FOR USE WITH LPG & NH<sub>3</sub> TRANSFER SYSTEMS

The ME808-16 Series valves feature our new modular Excelsa-Flange 4-bolt inlet flange design that can be easily adapted to both NTP thread or socket weld type A companion flanges (ME840 & ME841 Series) ranging from 1-1/4" to 2" in diameter making it universal to piping sizes within this range. This innovative system allows installers the ability to eliminate unnecessary connections as well as possible leak points by integrating a convenient 4 bolt flange union at the valve inlet. The Turbo-Flo LE system provides a safe, ergonomic and efficient solution for liquid or vapor transfer applications while increasing productivity and dramatically reducing fugitive product emissions. For use with bobtail, transport, railcar and bulk plant applications.



ME808-16

### FEATURES

- Universal 4 bolt inlet flange for built in union joint
- Reduces product emissions 99.6% over standard valve combinations
- 100% compatible with all existing acme transfer connections
- Heavy duty spring loaded safety latch prevents accidental opening of valve
- Cam operated vapor equalization feature for smooth valve operation
- All stainless internal components
- Factory installed hydrostatic relief valve
- Specially formulated low temperature valve seals for maximum performance and life under all operating conditions
- Integrated Back Check (IBC) feature to allow trapped liquid to be forced back upstream of the valve if liquid is trapped downstream of the valve seat.
- Available with brass or steel acme connections.

Part No.	Description	Discharge at Disconnect	Material	Mating Flange Type	Weight (lbs.)
ME808-16	Low Emission Transfer Valve 4 Bolt Type B Flange x 3-1/4" M. Acme Fixed	3.2 CC	Ductile/Brass	A	12.3
ME808A-16	Low Emission Transfer Valve 4 Bolt Type B Flange x 3-1/4" M. Acme Fixed - w/ screen	3.2 CC	Ductile/Brass	A	12.3
ME808S-16	Low Emission Transfer Valve 4 Bolt Type B Flange x 3-1/4" M. Acme Fixed	3.2 CC	Ductile/Steel	A	12.3
ME808SA-16	Low Emission Transfer Valve 4 Bolt Type B Flange x 3-1/4" M. Acme Fixed - w/ screen	3.2 CC	Ductile/Steel	A	12.4
Accessories					
Part No.	Description				
ME807PIB	MEC Smart Interlock Sensor Kit for ME807 Series				



# TURBO-FLO LE SHUTOFF VALVE

FOR USE WITH LPG & LH3 TRANSFER SYSTEMS

This revolutionary system provides a safe, ergonomic and efficient solution to transfer applications while increasing productivity and dramatically reducing fugitive product emissions. For use with bobtail, transport, railcar and bulk plant applications.



**ME807-16**

## FEATURES

- Reduces product emissions 99.6% over standard valve combinations
- 100% compatible with all existing acme transfer connections
- Heavy duty spring loaded safety latch prevents accidental opening of valve
- Cam operated vapor equalization feature for smooth valve operation
- All stainless internal components
- Factory installed hydrostatic relief valve
- Specially formulated low temperature valve seals for maximum performance and life under all operating conditions
- Integrated Back Check (IBC) feature to allow trapped liquid to be forced back upstream of the valve if liquid is trapped downstream of the valve seat
- Available with brass or steel acme connections
- Designed for bi-directional flow of product
- Integrated pilot feature allows the ME807 to equalize and open only when connected to mating connection ensuring maximum safety.



**ME135**

The **ME135 discharge hose adapter** allows transport hoses to be adapted to work with the ME807 LE Shutoff Valve while providing a flexible connection in the transport trailer hose bleed down lines.

Turbo-Flo LE Transfer Valves			
Part No.	Description	Discharge at Disconnect	Material
<b>ME807-16</b>	Low Emission Transfer Valve 2" FNPT x 3-1/4" M. Acme Fixed	.09 CC	Ductile/Brass
<b>ME807S-16</b>	Low Emission Transfer Valve 2" FNPT x 3-1/4" M. Acme Fixed	.09 CC	Ductile/Steel
Accessories			
Part No.	Description		
<b>ME134WR</b>	3-1/4"F.Acme x 2MPT Filler Coupling w/Retainer Ring & 3/8"FNPT Port-Brass/Steel		
<b>ME134SWR</b>	3-1/4"F.Acme x 2MPT Filler Coupling w/Retainer Ring & 3/8"FNPT Port-Steel/Steel		
<b>ME135</b>	3-1/4"F.Acme x 2MPT Filler Coupling w/Ring & Discharge Hose-Brass Nut/Steel Stem		
<b>ME806-16</b>	Low Emission Transfer Valve 2" FNPT x 3-1/4" F. Acme Swivel		
<b>ME806S-16</b>	Low Emission Transfer Valve 2" FNPT x 3-1/4" F. Acme Swivel		
<b>ME807PIB</b>	Smart Interlock Technology Sensor Bracket Assembly for ME807 Series		



# TURBO-FLO LE TRANSFER SYSTEM

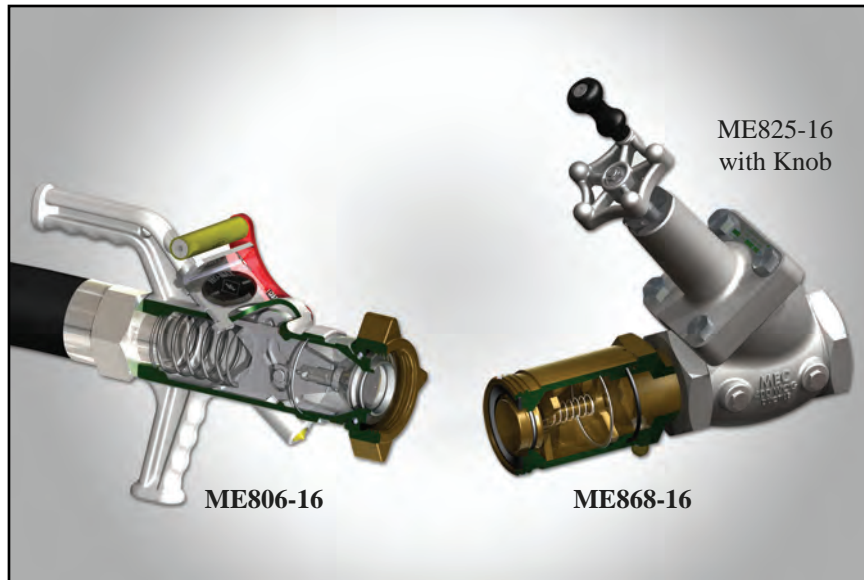

Up to **55%** increased flow when entire system is installed compared to a standard globe valve system

The **TURBO-FLO LE™** (Low Emission) Transfer System is the industries **most efficient and cost-effective way** to transfer LP-Gas in bobtail, transport, railcar, and bulk plant applications. This product will pay for itself through gas savings during disconnect and its increased flow rate. While any part of this system is interchangeable with other standard systems, to receive **maximum** savings, all three products (LE Transfer Valve, LE Acme Adapter, and MEC Globe Valve) must be used simultaneously.

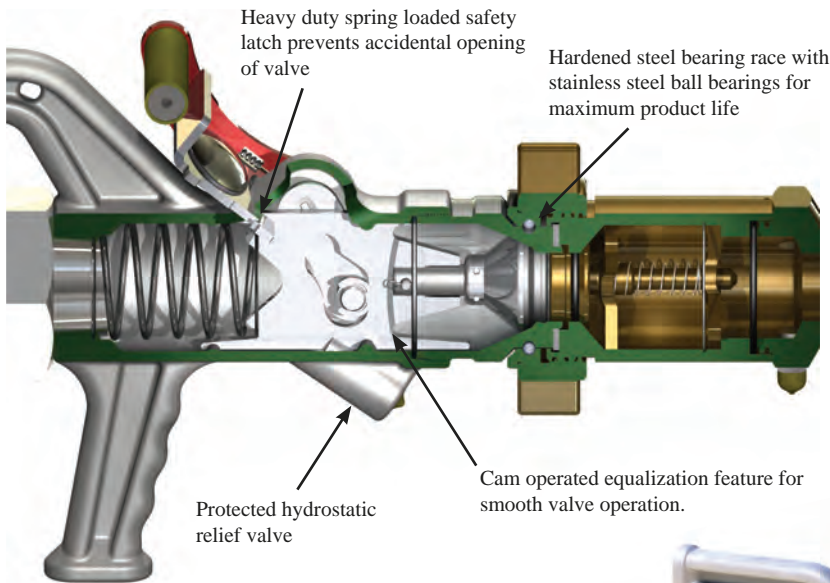

### FEATURES

- Reduces product emissions by 99.6% over standard valves
- 100% compatible with existing Acme transfer connections
- All stainless steel internal components
- Convenient carrying handles and custom fit dust plug with lanyard (not shown)

Pilot orifice allows the valve to equalize and open only when the valve is attached to the mating part. When the valve is not attached to the mating part, the valve cannot equalize and will not open.

TURBO-FLO LE Transfer Valve				
Part No.	Inlet (FNPT)	Outlet (F. Acme)	Discharge at Disconnect	Material
ME806-16	2"	3-1/4"	.09 CC	Ductile/Brass
ME806S-16*	2"	3-1/4"	.09 CC	Ductile/Steel

\* Rated for LP-Gas & NH<sub>3</sub>



**ME806-16**  
U.S. Patented  
Canada Patent Pending



# TURBO-FLO LE TRANSFER SYSTEM

TRUCK & PLANT EQUIPMENT

Turbo-Flo LE Acme Adapters								
Part No.	Inlet (M. Acme)	Outlet (MNPT)	Factory Installed Screen	Discharge at Disconnect	Material	Accessories		
						Mechanical Brake Interlock Retro-Fit	Electronic Proximity Interlock Kit	Back Check Test Adapter
ME866-8	1-3/4"	1"	No	.16 CC	Brass	—	—	—
ME866A-8	1-3/4"	1"	Yes	.16 CC	Brass	—	—	—
ME866-10	1-3/4"	1-1/4"	No	.16 CC	Brass	—	—	—
ME866A-10	1-3/4"	1-1/4"	Yes	.16 CC	Brass	—	—	—
ME867-10	2-1/4"	1-1/4"	No	1.96 CC	Brass	—	—	—
ME867A-10	2-1/4"	1-1/4"	Yes	1.96 CC	Brass	—	—	—
ME868-16*	3-1/4"	2"	No	3.11 CC	Brass	ME868MIB	ME868PIB	MEP105
ME868A-16*	3-1/4"	2"	Yes	3.11 CC	Brass	ME868MIB	ME868PIB	MEP105
ME868-24*	3-1/4"	3"	No	3.11 CC	Brass	ME868MIB	ME868PIB	MEP105
ME868A-24*	3-1/4"	3"	Yes	3.11 CC	Brass	ME868MIB	ME868PIB	MEP105

\* Not for use in conjunction with soft seat back check



**ME868-16**  
U.S. Patented  
Canada Patent Pending

## TURBO-FLO LE TRANSFER SYSTEM ACCESSORIES

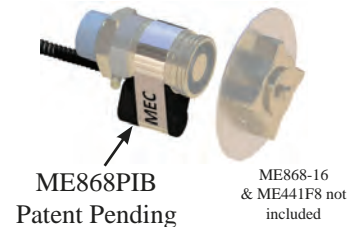

**ME868BLK** – “Bypass Line Kit” is used to create a one-way closed loop between the upstream and downstream sides of a Marshall Excelsior 2” globe valve when used in conjunction with a ME868 Series low emission Acme adapter. The kit features a brass one-way check valve and preformed heavy wall copper tubing with brazed end fittings for durability. This product is intended to prevent over pressurization of the ME868 Series low emission Acme adapters making them truly low emission. This product will also greatly reduce pressures within the ME868 Series adapters thereby decreasing any wear that may occur to the shutoff valves or the low emission Acme adapter.

**ME868MIB** – “Mechanical Interlock Bracket” allows for a standard Parker style pneumatic air roller valve normally used in conjunction with standard bobtail brake interlock systems to be retro-fit to the ME868 Series low emission Acme adapters. This bracket system allows the standard brake interlock system and connections to be moved forward to the end of the low emission adapter where normal contact with the ME441F8 flange Acme cap can occur. The kit includes all bracketing and mounting hardware. (Kit does not include Parker style pneumatic roller valve)

**ME868PIB** – “Proximity Interlock Bracket” uses the new MEC smart interlock technology designed to connect with the Allison automatic transmission “auxiliary function range inhibit” preventing operation of the bobtail while this connection is in use. MEC smart interlock technology incorporates a high grade TURCK proximity switch that senses the presence of the stainless steel flange on the ME441F8 Acme cap when secured tightly to the ME868 Series low emission Acme adapter. This kit comes complete with all mounting hardware, MEC smart interlock technology and wiring harness to reach 5’ below the deck of the bobtail.

**MEP105** – This adapter allows for the periodic evacuation and testing of a bobtail’s internal back check valve during five year inspection requirements. The adapter fits snugly into the female Acme side of a ME130 which then can be threaded onto the ME868 Series low emission Acme adapter pushing the valve poppet to the open position thereby depressurizing the system for testing purposes. (Note: Be sure to consult instruction manual supplied with MEP105 test adapter before attempting use.)



Marshall Excelsior offers three types of globe and angle valves (standard, integrated pilot feature (P) or integrated back check feature (IBC)) depending on the intended application. All Marshall Excelsior globe and angle valves are designed to withstand extreme temperatures and can **increase flow up to 70 percent** over a standard globe valve. The 35 degree seat angle on the 1-1/4" and larger globe valves make them ergonomically designed for bobtail, transport and bulk plant applications. This 35 degree seat angle also allows up to 70 percent more flow. The 1-1/4" and larger globe and angle valves have an optional 360 degree rotating ME829 **E-Z Turn** knob

To increase the longevity of the seal, all Marshall Excelsior globe and angle valves have a 360 degree rotating seal that stops rotating when it contacts the sealing surface while the valve continues to be tightened. The 1-1/4" and larger models feature ball bearings to facilitate increased seal life.

All 1-1/4" and larger globe and angle valves come with an upstream and downstream plugged port. The boss of these ports are large enough to drill and tap a 3/4" FNPT hole for a jumper line or standard by-pass valve.

These valves are mainly used in piping systems to control liquid or vapor flow in bulk plants, bobtails, transports, pumps or compressors. Globe valves are designed to be installed in a straight section of piping and angle valves are designed to be installed when a 90 degree directional change is needed in the piping.

Change the sealing compound and Marshall Excelsior's

globe and angle valves can be used in numerous industries including, but not limited to LP-Gas, anhydrous ammonia, petrochemical and chemical applications. The standard seal compound is Nitrile with Teflon® or Viton® also available. Contact us if you have a need for a different seal compound.

**Marshall Excelsior valves are designed to be hand tightened. Using wrenches or excess force to open or close the valve can cause damage to the seal, decreasing the valve's life.**

**Installation Note:** Before installing a globe or angle valve, the piping system and container must be free of dirt, debris, foreign matter and other particles, large or small, that could damage the sealing surface or seal of the valve. A minimal amount of pipe sealant should be used on the mating part. Excess pipe sealant can also cause damage to the seal surface or seal. Damage to the sealing surface or the seal will cause the valve to leak.

To avoid damage to the valve or piping, due to pressure build-up from temperature changes, a hydrostatic relief valve should be installed where liquid can be trapped between two shutoff valves.

A vent valve should be installed on the downstream side of the globe or angle valve if the angle valve is used as a shutoff valve at the end of a loading hose. This allows the operator to vent the trapped liquid before disconnect.

Teflon® is a trademark of DuPont Company and Viton® is a trademark of DuPont Performance Elastomers

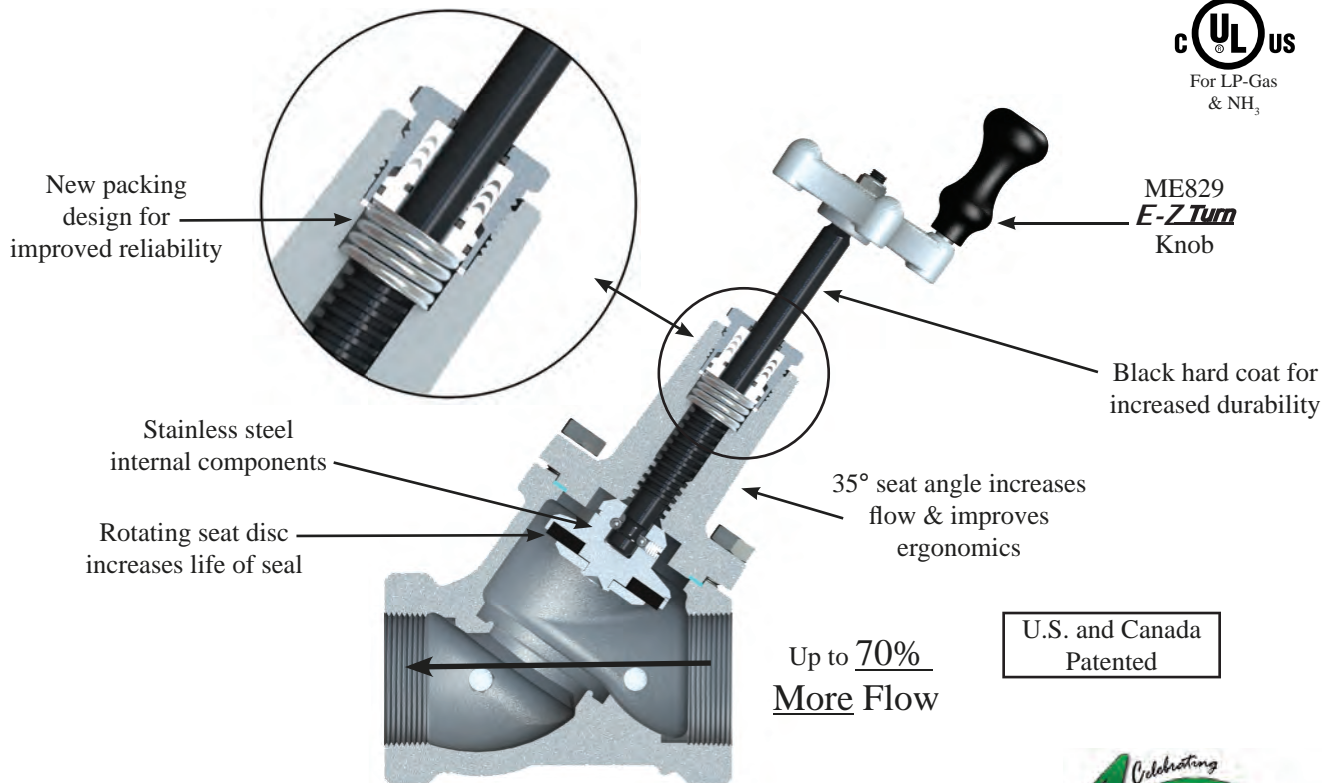

# High Flow **GLOBE AND ANGLE VALVES**

## Excelsa-Flange SERIES

The ME813, ME818, ME819 and ME823 Series valves feature our new modular **Excelsa-Flange** 4 Bolt inlet/outlet design that can be easily adapted to both NTP thread or socket weld type A companion flanges (ME840 & ME841 Series) ranging from 1-1/4" to 2" in diameter making it universal to piping sizes within this range. This innovative system allows installers the ability to eliminate unnecessary connections as well as possible leak points by integrating a convenient 4 bolt flange union at the valve inlet/outlet connections.

**ME813-16**  
2" Double Flange Angle Valve



**ME823-16**  
2" Double Flange  
Globe Valve



**ME819-16**  
2" Flange x NPT  
Globe Valve



### FEATURES

- All stainless steel internal components with rotating seat disc design & V-cup Teflon® packing stem seals
- Double lead acme stem thread ensures quick and efficient operation
- Durable ductile iron valve body with zinc plating finish
- 1-1/4" & larger globe valves have 35° seat angle for maximum product flow
- 1-1/4" & larger globe valve designed ergonomically correct for bobtail transport and bulk plant applications
- Rated for 400 WOG
- Operating temperature -40° to +212° Fahrenheit
- Up to **70% MORE FLOW** than the nearest competitor
- 1/4" FNPT or 1/2" FNPT plugged accessory ports upstream and downstream of valve seat
- Standard Nitrile seat, optional Teflon or Viton seat

Angle	Globe	Description	Side Ports	Inlet	Outlet	Mating Flange Type	Weight (lbs.)	
							Angle	Globe
ME813-10	ME823-10	1-1/4" - 4 Bolt Full Flow Double Flange Valve	1/4" FNPT	4 Bolt Flange Type B	4 Bolt Flange Type B	A	14.8	15.3
—	ME822-16	2" - 4 Bolt Full Flow Double Flange Valve	1/2" FNPT	4 Bolt Flange Type B	4 Bolt Flange Type B	A	—	19.7
ME813-16	ME823-16	2" - 4 Bolt Full Flow Double Flange Valve	1/4" FNPT	4 Bolt Flange Type B	4 Bolt Flange Type B	A	17.6	19.6
—	ME818-16	2" - 4 Bolt Full Flow Single Flange Valve	1/2" FNPT	4 Bolt Flange Type B	2" FNPT	A	—	17.7
—	ME819-10	1-1/4" - 4 Bolt Full Flow Single Flange Valve	1/4" FNPT	4 Bolt Flange Type B	1-1/4" FNPT	A	—	14.0
—	ME819-16	2" - 4 Bolt Full Flow Single Flange Valve	1/4" FNPT	4 Bolt Flange Type B	2" FNPT	A	—	17.7

Viton® and Teflon® are trademarks of DuPont Performance Elastomers.





ME825-6  
Vent Valve Not  
Included

## FEATURES

- All stainless steel internal components with rotating seat disc design & V-cup Teflon® packing stem seals
- Double stem seal design ensures leak free operation
- Double lead stem thread ensures quick and efficient operation
- Durable ductile iron valve body with automotive grade powder coat finish
- 1-1/4" & larger globe valves have 35° seat angle for maximum product flow
- 1-1/4" & larger globe valve designed ergonomically correct for bobtail transport and bulk plant applications
- 1-3/4", 2-1/4" & 3-1/4" Acme threads available on globe valves
- Rated for 400 WOG
- Operating temperature -40° to +212° Fahrenheit

Part No.		Inlet (FNPT)	Outlet	Side Port (T)	No. of Side Ports	Flange Style Bonnet	Accessories			
Angle	Globe						E-Z Turn Knob	Push-To-Turn Locking Handwheel Kit	Hydrostatic Relief Valves	Vent Valves
ME815-4	ME825-4	1/2"	1/2" FNPT	1/4"	2	No	—	—		
ME815-6	ME825-6	3/4"	3/4" FNPT	1/4"	2	No	—	—		
ME815-8	ME825-8	1"	1" FNPT	1/4"	2	No	—	—		
ME815-10	ME825-10	1-1/4"	1-1/4" FNPT	1/4"	2	Yes	ME829	ME815-16LHK	MEH225 MEH225SS MEH25/450	MEJ400 MEJ400SC MEJ402S
—	ME826-10	1-1/4"	1-3/4" M. Acme	1/4"	2	Yes	ME829	ME815-16LHK		
—	ME827-10	1-1/4"	2-1/4" M. Acme	1/4"	2	Yes	ME829	ME815-16LHK		
ME815-12	ME825-12	1-1/2"	1-1/2" FNPT	1/4"	2	Yes	ME829	ME815-16LHK		
ME815-16	ME825-16	2"	2" FNPT	1/4"	2	Yes	ME829	ME815-16LHK		
—	ME824-16	2"	2" FNPT	1/2"	2	Yes	ME829	ME815-16LHK	MEH50/460	—
ME815-2F	ME825-2F	2"-300LB Flanged	2"-300LB Flanged	1/4"	2	Yes	ME829	ME815-16LHK	MEH225 MEH225SS MEH25/450	MEJ400 MEJ400SC MEJ402S
ME815-24	ME825-24	3"	3" FNPT	1/4"	2	Yes	included	—		
ME815-3F		3"-300LB Flanged	3"-300LB Flanged	1/4"	2	Yes	included	—		

To order Teflon® or Viton® Seal add "T" for Teflon® and "V" for Viton® after the prefix part number i.e. ME815T-10 or ME815V-10

Teflon® is a trademark of DuPont Company and Viton® is a trademark of DuPont Performance Elastomers.



# High Flow **GLOBE AND ANGLE VALVES**

## Next Generation **Excelsa-Flange** SERIES

The *Next Generation* Flanged 2" Globe and Angle Valves feature our new modular **Excelsa-Flange** 4 Bolt inlet/outlet design that can be easily adapted to both NPT thread or socket weld type A companion flanges (ME840 & ME841 Series) ranging from 1-1/4" to 2" in diameter making it universal to piping sizes within this range. This innovative system allows installers the ability to eliminate unnecessary connections as well as possible leak points by integrating a convenient 4 bolt flange union at the valve inlet/outlet connections.

- ALL OF THE SAME GREAT FEATURES OF THE ORIGINAL FULL FLOW MEC GLOBE VALVES WITH ADDITIONAL PRODUCT PERFORMANCE ENHANCEMENTS.

**Pilot Feature: (P)** This globe valve model incorporates a pilot orifice feature to facilitate pressure equalization in sections of system piping that have bidirectional flow or high differential pressures. This greatly reduces the opening torque required and prevents premature wear of the valve seat.

**Integrated Back Check Feature: (IBC)** These globe and angle valve models incorporate an integrated back check feature to allow trapped downstream pressure to automatically bypass to the upstream side of the valve. These valves are designed for systems with flow in one direction, creating a closed loop system that prevents the product from relieving to the atmosphere making for a low emission, more environmentally friendly option.

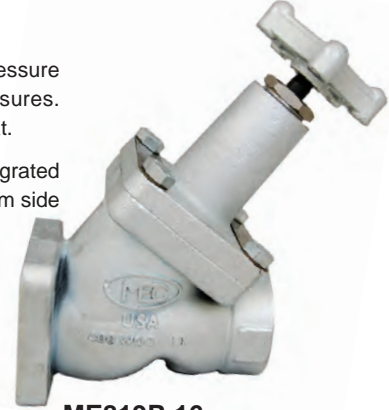

**ME819P-16**  
2" - Flange x NPT  
Globe Valve

**PATENT  
#8,596,301**

Integrated Back Check  
Feature

**ME823IBC-16**

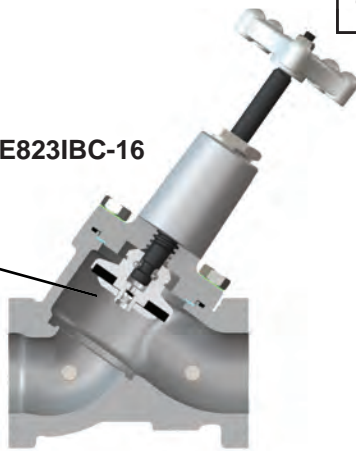
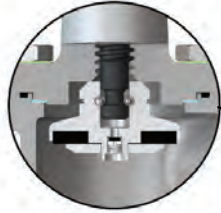

Pilot Feature

**ME823P-16**

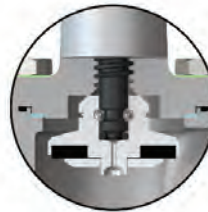

Angle	Globe	Description	Side Ports	Inlet	Outlet	Mating Flange Type	Weight (lbs.)	
							Angle	Globe
ME813IBC-16	ME823IBC-16	2" Full Flow 4 Bolt Double Flange (IBC) Valve	1/4" FNPT	4 Bolt Flange Type B	4 Bolt Flange Type B	A	17.6	20.1
—	ME822IBC-16	2" Full Flow 4 Bolt Double Flange (IBC) Valve	1/2" FNPT	4 Bolt Flange Type B	4 Bolt Flange Type B	A	—	19.7
ME813P-16	ME823P-16	2" Full Flow 4 Bolt Double Flange (P) Valve	1/4" FNPT	4 Bolt Flange Type B	4 Bolt Flange Type B	A	18.1	20.1
—	ME822P-16	2" Full Flow 4 Bolt Double Flange (P) Valve	1/2" FNPT	4 Bolt Flange Type B	4 Bolt Flange Type B	A	—	20.1
—	ME818IBC-16	2" Full Flow 4 Bolt Single Flange (IBC) Valve	1/2" FNPT	4 Bolt Flange Type B	2" FNPT	A	—	18.2
—	ME818P-16	2" Full Flow 4 Bolt Single Flange (P) Valve	1/2" FNPT	4 Bolt Flange Type B	2" FNPT	A	—	18.2
—	ME819IBC-16	2" Full Flow 4 Bolt Single Flange (IBC) Valve	1/4" FNPT	4 Bolt Flange Type B	2" FNPT	A	—	18.1
—	ME819P-16	2" Full Flow 4 Bolt Single Flange (P) Valve	1/4" FNPT	4 Bolt Flange Type B	2" FNPT	A	—	18.1



## High Flow **GLOBE AND ANGLE VALVES**

These *Next Generation High Flow* globe and angle valves have the same great features of the original *High Flow Marshall Excelsior* globe and angle valves with additional product performance enhancements. These globe and angle valves provide a positive shutoff that is highly reliable with *High Flow* performance with bidirectional flow or reduced product emissions.

**Integrated Back Check Feature (IBC)** - Designed for use in sections of piping where the trapped liquid pressure may exceed 100 psig between two valves. When trapped liquid pressure exceeds 100 psig, the integrated back check feature automatically bypasses trapped downstream system pressure through the valve seat to the upstream side of the valve into the product container or piping. A closed looped system is created because the 100 psig is far below the 400—500 psig set pressure of a hydrostatic relief valve keeping the product in the system and reducing product emissions.

**WARNING:** NFPA 58 requires that a hydrostatic relief valve be installed into any section of piping that could allow liquid to become trapped between two shutoff valves.

**Integrated Pilot Feature (P)** - Designed for sections of piping that have bidirectional flow. Standard globe and angle valves installed in bidirectional systems can have a potential for back pressure to build-up on the upstream side of a closed valve. This pressure adds to the force required to open the valve causing additional wear to the valve stem and seat material. The integrated pilot feature allows the first portion of stem travel to unseat the pilot orifice, automatically equalizing the system pressure prior to unseating the valve holder seal. This greatly reduces the opening torque required in bidirectional systems and prevents premature wear of the primary valve seat material and valve components.

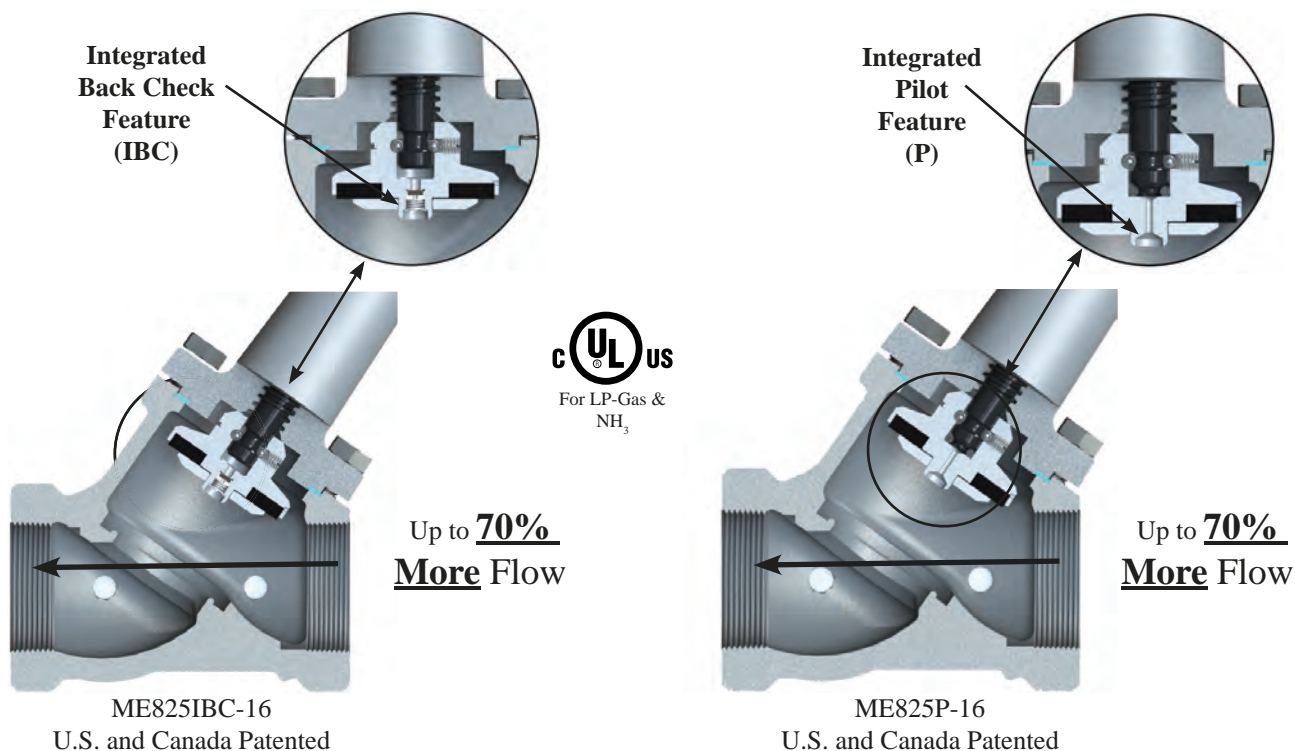

Part No.				Inlet (FNPT)	Outlet	Side Port (FNPT)	No. of Side Ports	Flange Style Bonnet	Accessories		
Angle		Globe							E-Z Turn Knob	Hydrostatic Relief Valves	Vent Valves
Integrated Back Check	Pilot Feature	Integrated Back Check	Pilot Feature								
ME815IBC-16	ME815P-16	ME825IBC-16	ME825P-16	2"	2" FNPT	1/4"	2	Yes	ME829	MEH225 MEH225S MEH25/450	MEJ400 MEJ400SC MEJ402S
—	—	ME828IBC-16	ME828P-16	2"	3-1/4" Male Acme	1/4"	2	Yes	ME829		
—	—	ME824IBC-16	ME824P-16	2"	2" FNPT	1/2"	2	Yes	ME829	MEH50/460	—



# High Flow **GLOBE AND ANGLE VALVES**

## Excelsa-Flange 2" BOTTOM PORT / INTEGRATED PILOT VALVE

Provides a positive shut-off valve that is highly reliable with full flow performance while providing bi-directional flow. Ideally suited for use on transport trailers with 1/2" blow down lines to provide rapid and complete product evacuation prior to disconnecting transfer hose. Valves can be purchased with hydrostatic relief valves pre-installed on the out board side port of the globe valve main seal.

- All of the same great features of the original full flow MEC globe valves with additional product performance enhancements.

**Pilot Feature:** (P) This globe valve model incorporates a pilot orifice feature to facilitate pressure equalization in sections of system piping that have bidirectional flow or high differential pressures. This greatly reduces the opening torque required and prevents premature wear of the valve seat.

The **Excelsa-Flange 2"** bottom port operated flanged globe valves feature our new modular Excelsa-Flange 4 bolt inlet/outlet flange design that can be easily adapted to both NPT thread or socket weld Type A companion flanges (ME840 & ME841 Series) ranging from 1-1/4" to 2" in diameter making it universal to piping sizes within this range. This innovative system allows installers the ability to eliminate unnecessary connections as well as possible leak points by integrating a convenient 4 bolt flange union at the valve inlet/outlet connections.

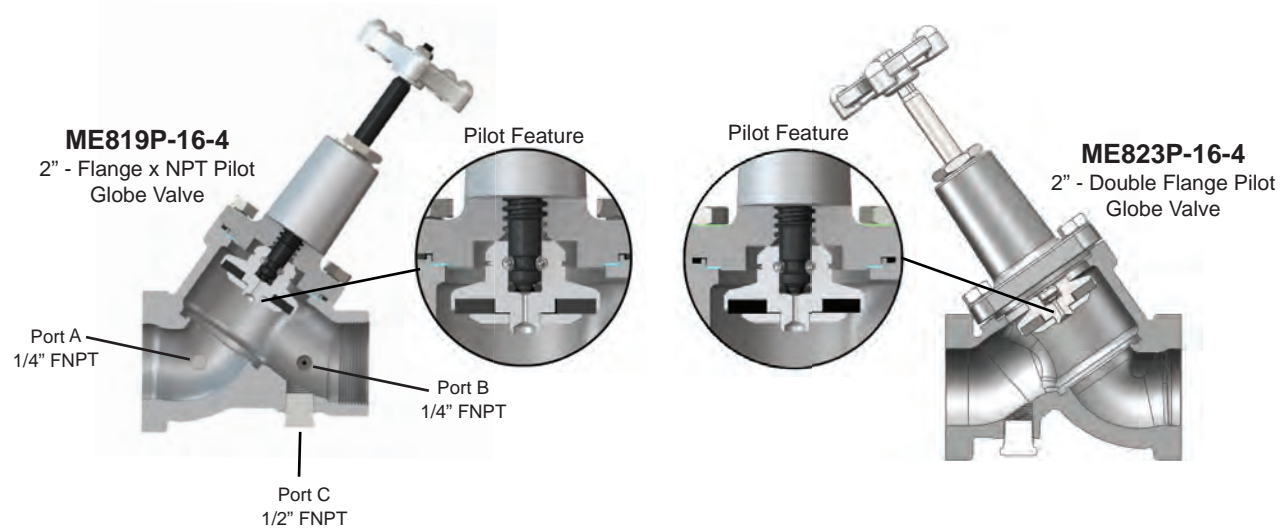

Part No	Description	1/4" FNPT Side Port A	1/4" FNPT Side Port B	1/2" FNPT Bottom Port C	Inlet	Outlet	Mating Flange Type	Weight (lbs)
ME822P-16-4*	2" Full Flow 4 Bolt Flange (P) Valve	Plugged	Plugged	Plugged	4 Bolt Flange Type B	4 Bolt Flange Type B	A	20.2
ME823P-16-4		Plugged	Plugged	Plugged		4 Bolt Flange Type B	A	20.1
ME823P-16H-4		Plugged	MEH225	Plugged		4 Bolt Flange Type B	A	20.1
ME823P-16HSS-4		Plugged	MEH225SS	Plugged		4 Bolt Flange Type B	A	20.1
ME818P-16-4*		Plugged	Plugged	Plugged		2" FNPT	A	18.2
ME819P-16-4		Plugged	Plugged	Plugged		2" FNPT	A	18.2
ME819P-16H-4		Plugged	MEH225	Plugged		2" FNPT	A	18.2
ME819P-16HSS-4		Plugged	MEH225SS	Plugged		2" FNPT	A	18.2

\*Indicates all ports 1/2" FNPT



# High Flow **GLOBE AND ANGLE VALVES**

## 2" Next Generation - 1/2" BOTTOM PORT

Provides a positive shut-off valve that is highly reliable with *High Flow* performance while providing bi-directional flow. Ideally suited for use on transport trailers with 1/2" blow down lines to provide rapid and complete product evacuation prior to disconnecting the transfer hose. Valves can be purchased with hydrostatic relief valves pre-installed in the side port of the globe valve downstream of the main seal.

- All of the same great features of the original full flow MEC globe valves with additional product performance enhancements.
- **Pilot Feature: (P)** These globe valve models incorporate a pilot orifice feature to facilitate pressure equalization in sections of system piping that have bidirectional flow or high differential pressures. This greatly reduces the opening torque required and prevents premature wear of the valve seat.

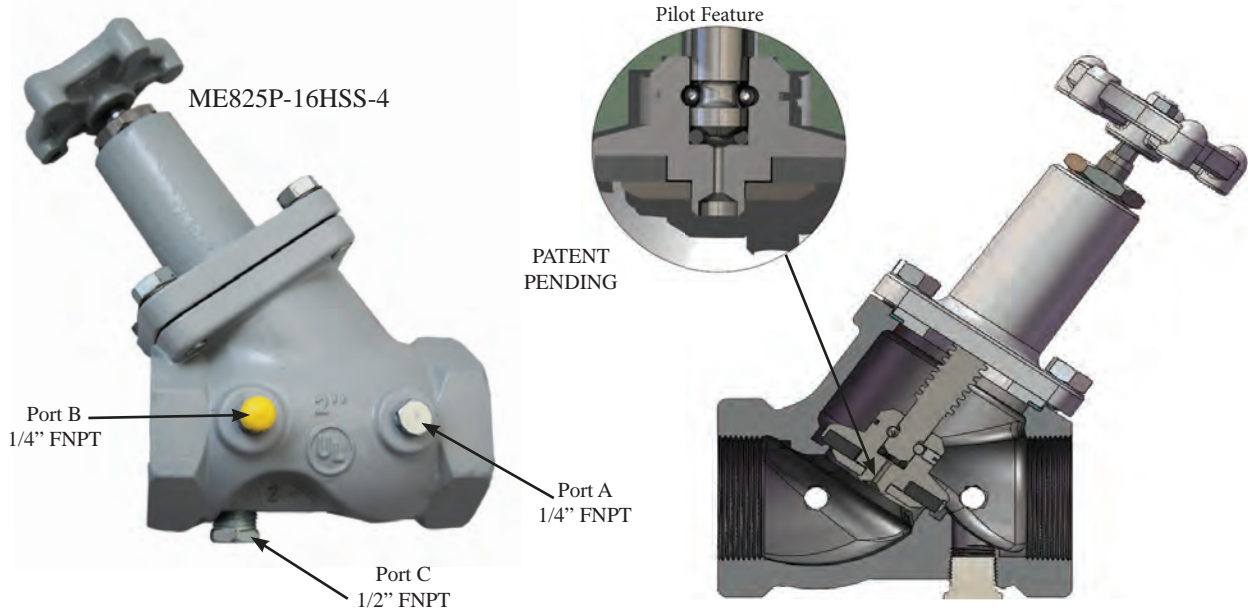

Next Generation Globe and Angle Valves						
Part No.	Description	1/4" FNPT Side Port A	1/4" FNPT Side Port B	1/2" FNPT Bottom Port	Inlet/Outlet	Accessories
						E-Z Turn Knob
ME825P-16-4	Full Flow Valve with Integrated Pilot Feature	Plugged	Plugged	Plugged	2" FNPT	ME829
ME825P-16H-4	Full Flow Valve with Integrated Pilot Feature	Plugged	MEH225	Plugged	2" FNPT	ME829
ME825P-16HSS-4	Full Flow Valve with Integrated Pilot Feature	Plugged	MEH225SS	Plugged	2" FNPT	ME829

## **PUSH-TO-TURN LOCKING HANDWHEEL KIT**

Helps prevent accidental opening of any 1-1/4", 1-1/2", or 2" MEC angle or globe valve configuration. Once installed the kit requires the operator to push down on the hand wheel to engage the valve stem in order to open or fully close the valve making it a deliberate action to actuate. The ejection spring disengages the handwheel from the stem when released, preventing unintentional opening of the valve.

Part No.	Description
ME815-16LHK	Push-To-Turn Locking Handwheel Kit for all 1-1/4", 1-1/2" & 2" MEC Angle / Globe Valves
Note: MEC strongly recommends use of ME829 EZ-Turn Handwheel knob to promote ease of use for this product (NOT INCLUDED IN ME815-16LHK KIT).	

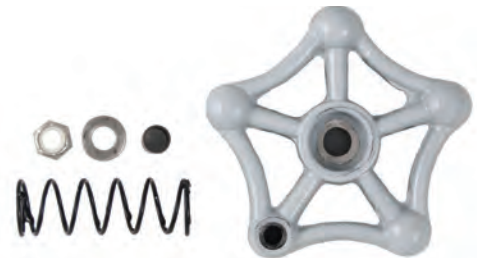

# GLOBE VALVES

## FULL PORT - FLANGED

The Full Port Flanged Globe Valves provide all the servicability features of a traditional globe valve with the full port flow capacity of a ball valve. Flanged end connections facilitate easy servicing along with a replaceable valve seat providing long service life for your investment. The valve also features an integrated pilot feature allowing pressure equalizing across the valve seat for bi-directional system flow.

### FEATURES

- Has same great reliable and durable teflon stem packing glands as our other globe valves
- Features exclusive slip cam construction for full port flow rates
- All stainless steel internal component construction for maximum corrosion resistance
- Removable bonded main seat disc assembly
- Same overall length as ANSI ball valve
- **Pilot Feature: (P)** These globe valve models incorporate a pilot orifice feature to facilitate pressure equalization in sections of system piping that have bidirectional flow or high differential pressures. This greatly reduces the opening torque required and prevents premature wear of the valve seat.

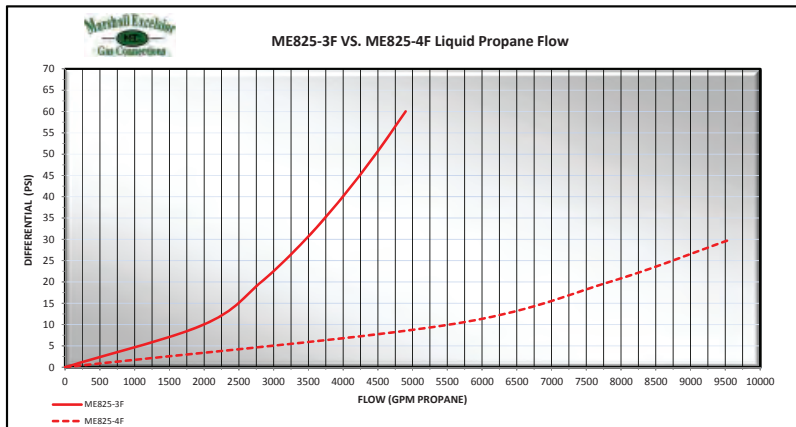
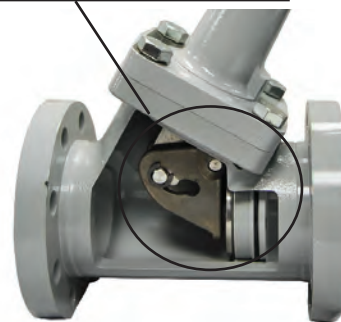
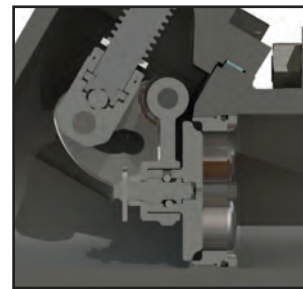

Part No.	Description	Side Port	No. of Side Ports	Inlet	Outlet
ME825-3F	Full Port Globe Valve with Integrated Pilot Feature	1/4" FNPT	2	3"-300 LB	3"-300 LB
ME825-4F	Full Port Globe Valve with Integrated Pilot Feature	1/4" FNPT	2	4"-300 LB	4"-300 LB
Accessories					
Part No.	Description				
ME829	Black Handwheel E-Z Turn Knob Kit				
ME980SK-24	3" & 4"-300LB ESV & Globe Valve Flange Stud Kit				
ME904S-3F-027	3"-300 LB Spiral Ring Flange Gasket-Carbon Steel				
ME904S-4F-027	4"-300 LB Spiral Ring Flange Gasket-Carbon Steel				



# High Flow SOCKET WELD BODIES

## Excelsa-Flange SERIES

Marshall Excelsior offers the largest closing flow selection in the industry. These excess flow valves are intended for use in liquid or vapor. These tees and elbows are available in both 2" and 3" socket weld pipe configuration and maximize flow through system piping where a 90° turn must be made. Flow rates are maximized by an optimized flow path as well as nearly seamless piping joints reducing turbulence and focusing flow through the system. Ideally suited for pump discharge lines, transport loading/unloading tee assemblies, spray fill lines or any other piping application where piping is welded and high flow rates are desired.



**MEP995S-24/16**  
3" F. Socket Weld X (2") -2" F. Socket Weld Tee



**MEP996S-16**  
2" F. Socket Weld X 2" F. Socket Weld Tee

### FEATURES

- All steel construction for maximum durability and weldability
- Available in 2" & 3" Socket Weld configurations
- Coated for maximum corrosion resistance
- Approved for use in LPG or NH<sub>3</sub> service
- Rated 400 WOG

MEC Excelsa-Flange High Flow Socket Weld Tees		
Part No.	Description	Weight (lbs.)
MEP995S-16	Excelsa-Flange™ 2" x 2" x 2" Socket Weld High Flow Tee Body-Steel	6.1
MEP995SBW-16	Excelsa-Flange™ 2" x 2" x 2" Butt Weld High Flow Tee Body-Steel	4
MEP995S-24/16	Excelsa-Flange™ 3" x 2" x 2" Socket Weld High Flow Tee Body-Steel	7.8
MEC Excelsa-Flange High Flow Socket Weld Elbows		
Part No.	Description	Weight (lbs.)
MEP996S-16	Excelsa-Flange™ 2" x 2" Socket Weld High Flow Elbow Body-Steel	3.8
MEP996S-24	Excelsa-Flange™ 3" x 3" Socket Weld High Flow Elbow Body-Steel	6.7

NOTE: Available in Stainless Steel i.e. MEP995SS-16

# 4 BOLT UNIONS & COMPANION FLANGES

These 4 bolt unions can be used anywhere system piping needs to be joined together between shut off valves. Using piping unions such as these significantly improves the ease by which maintenance can be performed particularly where long runs or multiple directional changes are necessary. Our flange unions feature a captured o-ring design, hardened mounting bolts, and are available in NTP or Socket Weld configurations. Suitable for use in mobile or stationary applications.

### FEATURES

- All steel construction for maximum durability and weldability
- Available in 1-1/4" - 2" FNPT or Socket Weld configurations
- Zinc plated flange faces for maximum corrosion resistance
- No plating on weld surfaces for improved weld quality with minimum weld prep
- Approved for use in LPG or NH<sub>3</sub> service
- Rated 400 WOG

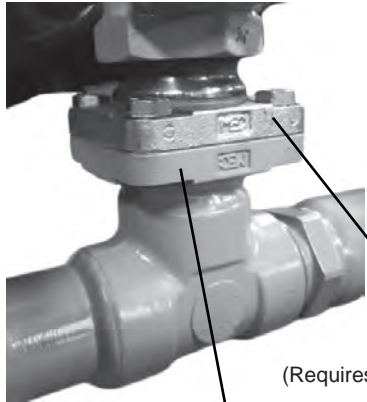

**ME841-16F**  
(Requires purchase of flat face flange)  
**TYPE A FLANGE**

**ME843-16-107**  
(Requires purchase of mating kit)  
**TYPE B FLANGE**



**MEP840/MEP841**

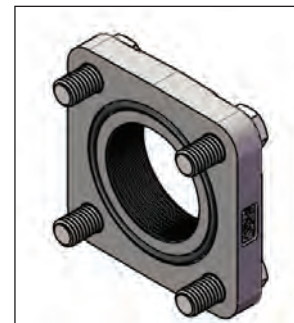

**TYPE "A"**

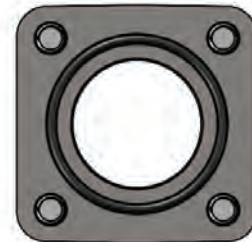

**O-RING SEAL**

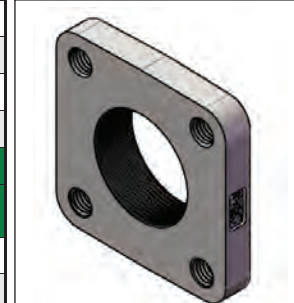

**TYPE "B"**

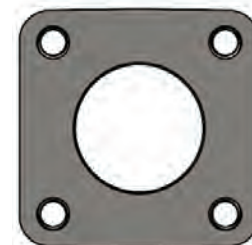

**FLAT FACE**

MEC Flat Face Flanges			
Part No.	Description	Flange Type	Weight (lbs.)
ME842-10-107	1-1/4" FNPT Tapped 4 Bolt Flat Face Flange Adapter	B	2.7
ME843-10-107	1-1/4" Socket Weld 4 Bolt Flat Face Flange Adapter	B	2.6
ME842-12-107	1-1/2" FNPT Tapped 4 Bolt Flat Face Flange Adapter	B	2.6
ME843-12-107	1-1/2" Socket Weld 4 Bolt Flat Face Flange Adapter	B	2.5
ME842-16-107	2" FNPT Tapped 4 Bolt Flat Face Flange Adapter	B	2.2
ME843-16-107	2" Socket Weld 4 Bolt Flat Face Flange Adapter	B	2.0
MEC Universal Flange Kit			
Part No.	Description	Flange Type	Weight (lbs.)
ME840-10F	1-1/4" FNPT 4 Bolt Flange Adapter Plate w/ Bolts & O-Ring	A	3.0
ME841-10F	1-1/4" Socket Weld 4 Bolt Flange Adapter Plate w/ Bolts & O-Ring	A	2.9
ME840-12F	1-1/2" FNPT 4 Bolt Flange Adapter Plate w/ Bolts & O-Ring	A	2.8
ME841-12F	1-1/2" Socket Weld 4 Bolt Flange Adapter Plate w/ Bolts & O-Ring	A	2.7
ME840-16F	2" FNPT 4 Bolt Flange Adapter Plate w/ Bolts & O-Ring	A	2.5
ME841-16F	2" Socket Weld 4 Bolt Flange Adapter Plate w/ Bolts & O-Ring	A	2.3
MEP840-10	1-1/4" FNPT 4 Bolt 90° Flange Adapter Elbow w/ Bolts & O-Ring	A	4.8
MEP841-10	1-1/4" Socket Weld 4 Bolt 90° Flange Adapter Elbow w/ Bolts & O-Ring	A	4.7
MEP840-12	1-1/2" FNPT 4 Bolt 90° Flange Adapter Elbow w/ Bolts & O-Ring	A	4.6
MEP841-12	1-1/2" Socket Weld 4 Bolt 90° Flange Adapter Elbow w/ Bolts & O-Ring	A	4.6
MEP840-16	2" FNPT 4 Bolt 90° Flange Adapter Elbow w/ Bolts & O-Ring	A	4.3
MEP841-16	2" Socket Weld 4 Bolt 90° Flange Adapter Elbow w/ Bolts & O-Ring	A	4.2

NOTE: Flanges available in Stainless Steel i.e. ME841SS-16F



## for BOBTAIL TRUCK / PLANT APPLICATIONS

These bypass valves are specifically designed to protect truck and plant pumps from damage due to excessive pressure while providing the industry's best bypass flow rates across a full range of set pressures. They feature wide open flow channels with an orifice weep hole chamber to prevent the valve from slamming open / closed. The weep hole chamber also helps prevent valve seat chatter by allowing constant pressure communication between both the upstream and downstream side of the seat.

### FEATURES

- All ductile iron body and bonnet
- All stainless steel wetted components
- Heavy duty protective stem cap
- Wide open flow channels for industry best flow rates
- Orifice weep hole to maintain constant pressure above and below valve seat
- Large range of set pressure springs
- Weldable steel NPT and socket weld flanges
- Zinc dichromate finish for maximum corrosion resistance
- Available with or without flanges factory assembled
- Flanges available 1-1/4" through 2" NPT and socket weld construction
- Universal 4 bolt, flanged body configuration
- Two 1/4" FNPT plugged auxiliary pressure ports
- Factory set at 125 PSI
- Alternative springs available: ME840-16-108-40 (20-40 PSI)  
ME840-16-108-70 (40-70 PSI)  
ME840-16-108-90 (70-90 PSI)  
ME840-16-108-150 (125-150 PSI)



**ME840-16/125**



Part No.	Description	Standard Spring Range*	Flange Type**
ME840-10-125	1-1/4" FNPT High Flow Bypass Valve	90-125 PSI	A
ME841-10-125	1-1/4" Socket Weld High Flow Bypass Valve	90-125 PSI	A
ME840-12-125	1-1/2" FNPT High Flow Bypass Valve	90-125 PSI	A
ME841-12-125	1-1/2" Socket Weld High Flow Bypass Valve	90-125 PSI	A
ME840-16-125	2" FNPT High Flow Bypass Valve	90-125 PSI	A
ME840C-16-125	2" FNPT Classic Flow Bypass Valve	90-125 PSI	A
ME841-16-125	2" Socket Weld High Flow Bypass Valve	90-125 PSI	A
ME840-125	1-1/4" -2" Universal High Flow Bypass w/o Flanges	90-125 PSI	B

\* Alternate spring ranges available. Please see replacement parts section in back of catalog.  
\*\* See previous page for flange options



**ME840-16-104**  
Standard Poppet



**ME840C-16-104**  
Classic Poppet

\*Designed to create higher differential pressure and increased poppet travel in low flow applications such as bobtails



## High Flow **BYPASS VALVES**

### for DISPENSING APPLICATIONS

Intended for use in small cylinder filling applications as a bypass and primer valve for turbine style dispensing pumps. These bypass valves feature a special “check ball” mechanism that helps eliminate vapor from liquid while keeping the pump flooded and properly primed. The priming and vapor elimination features in combination with the high flow bypass design significantly reduces pump wear and promotes seal longevity.

**FEATURES**

- Ductile iron body and bonnet construction
- Large range of set pressure springs
- Two 1/4" FNPT plugged auxiliary pressure ports (outlet side)
- Stainless steel main valve poppet
- Heavy duty protective stem cap
- Available in 3/4" & 1" FNPT threaded versions
- Factory set at 125 PSI
- Durable powder coat finish
- Alternative springs available: ME840-8-108-60 (25-60 PSI)  
ME840-8-108-225 (100-225 PSI)

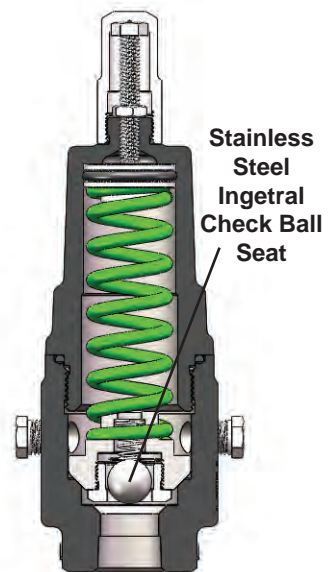

Part No.	Description	Standard Spring Range*
ME840-6-150	3/4" FNPT High Flow Bypass Valve	50-150 PSI
ME840-8-150	1" FNPT High Flow Bypass Valve	50-150 PSI

\* Alternate spring ranges available. Please see replacement parts section in back of catalog



## High Flow **BYPASS VALVES**

### for PLANT APPLICATIONS

Specifically designed for plant systems where maximum bypass flow is necessary to protect the pump from rapid pressure changes or over pressurization. Perfectly suited for 4" base mount pumps or larger pump applications.

**FEATURES**

- Ductile iron body and bonnet construction
- All stainless steel internal wetted components
- Bonnet / seat positioned at 35° angle for maximum product flow
- Downstream bleed port to boost product flow during bypass
- Two 1/4" FNTP plugged auxiliary pressure ports
- Heavy duty protective stem cap
- Factory set at 100 PSI
- Durable powder coat finish



Part No.	Description	Standard Spring Range*
ME840-24-100	3" FNPT High Flow Bypass Valve	0-100 PSI
ME840-24-200	3" FNPT High Flow Bypass Valve	0-200 PSI

\* Alternate spring ranges available. Please see replacement parts section in back of catalog



# HOSE END VALVES

*High Flow* LOW EMISSION

These hose end valves are leading the industry in minimal product loss during disconnect without sacrificing flow. They have instant full-on flow with the added protection of a quick closing, self-locking handle to prevent accidental opening of the valve during transport. They are designed to be used at the end of a filling hose on a bobtail, dispensing system or nurse tank.

## FEATURES

- All stainless steel component construction
- Molded and riveted on valve main seal
- Vents less than .50cc for minimal loss of product at disconnect
- Self-locking toggle handle prevents accidental valve opening
- Toggle handle and stem assembly rotate 360°
- Durable ductile iron valve body with automotive grade powder coat finish
- Stainless steel 1-3/4" female Acme insert cast into the handle
- No additional adapters or connectors needed for operation
- Optional extended version offers 6 inches of additional reach for filling underground containers or other hard to reach applications
- Optional composite style offers a durable lightweight handle that is resistant to frosting and cold transfer during the filling operation
- Optional factory installed **EZTurn** stainless steel swivel

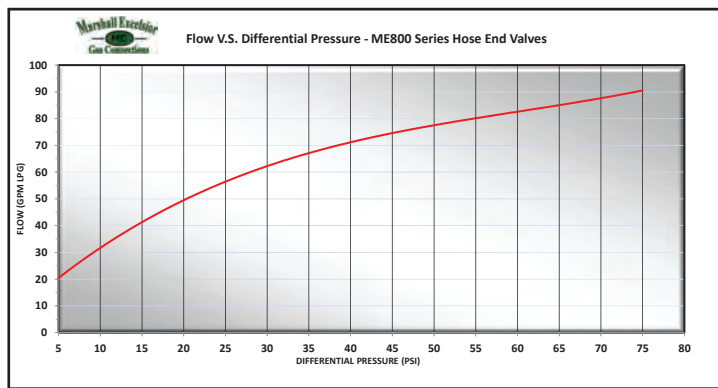

Part No.	Inlet (FNPT)	Outlet (F. Acme)	Handle Style	Handle Material	Factory Installed E-Z Turn Swivel	Extended Version	Accessories
							Holster
ME800	1"	1-3/4"	Standard	Aluminum	No	No	MEP801
ME800-6	3/4"	1-3/4"	Standard	Aluminum	No	No	MEP801
ME800WS	1"	1-3/4"	Standard	Aluminum	Yes	No	MEP801
ME800C	1"	1-3/4"	Standard	Composite	No	No	MEP801
ME800CWS	1"	1-3/4"	Standard	Composite	Yes	No	MEP801
ME800G	1"	1-3/4"	Fluted	Aluminum	No	No	MEP801
ME800G-6	3/4"	1-3/4"	Fluted	Aluminum	No	No	MEP801
ME800GWS	1"	1-3/4"	Fluted	Aluminum	Yes	No	MEP801
ME800GC	1"	1-3/4"	Fluted	Composite	No	No	MEP801
ME800GCWS	1"	1-3/4"	Fluted	Composite	Yes	No	MEP801
ME800EXT	1"	1-3/4"	Standard	Aluminum	No	Yes	No
ME800EXTWS	1"	1-3/4"	Standard	Aluminum	Yes	Yes	No





## HOSE END VALVE LOCK

Designed to prevent valve operation while in place, eliminating the possibility of accidental discharge and/or theft of product. Simply slide the lock over the handle/bonnet of the hose end or quick acting dispensing valve. For maximum security a common padlock can be installed.

### FEATURES

- All stainless steel construction
- 3/8" diameter through holes for standard 2-1/2" shackle style padlock

Part No.	Fits	Accessories	
		2-1/2" Deep Shackle Padlock	
		Keyed Alike	Keyed Different
ME540	ME800, ME810, ME820 Series	ME540P-KA	ME540P-KD



## HOSE END VALVE HOLSTER

Designed to provide a durable and convenient receptacle to store bobtail hose end delivery valves during over-the-road transit. This holster can be mounted fully above deck or partially below deck in left or right hand hose reel applications with an ergonomic angle providing optimum conditions for delivery personnel.

### FEATURES

- All aluminum and stainless steel construction
- Urethane anti-vibration valve sleeve to prevent incidental damage to delivery valve
- Machined adjustment ribs for easy, secure height adjustment
- Deck backing plate and all mounting hardware supplied



MEP801

U.S and Canada Patented

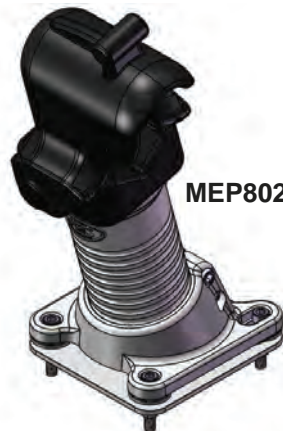

MEP802



MEP804

Part No.	Description	Fits	Accessories
MEP801	Bobtail Hose End Valve Holster-Aluminum	ME800 Series	MEP801H (Urethane Weather Hood)
MEP802	Bobtail Hose End Valve Holster-Aluminum w/ All Weather Hood	ME800 Series	MEP801-04 (Urethane Holster Strap)
MEP804	Bobtail Quick-Jaw Hose End Valve Holster -Aluminum w/ All Weather Hood	ME800 Series, AL363 or AL366 (Squibb Taylor)	MEP801H (Urethane Weather Hood) MEP801-04 (Urethane Holster Strap)



# HOSE END SWIVEL CONNECTIONS

The **ZTurn** hose end swivel connector allows the hose end valve to rotate 360° creating an easier connection to the tank filler valve while under pressure. It also promotes hose life by preventing twisting and kinking during reeling and unreeling from hose reel.

## FEATURES

- All stainless steel construction for maximum durability and corrosion resistance
- Large bearing surface for increased strength and durability
- 360° rotation under maximum working pressure of 400 psig
- Our **UL** LISTED seal pack design allows for extremely long life with no maintenance required
- Straight through bore for unobstructed flow characteristics
- See low emission hose end valves for factory installed **EZTurn**



Part No.	Inlet (FNPT)	Outlet (MNPT)
ME850SS-6	3/4"	3/4"
ME850SS-6/8	3/4"	1"
ME850SS-8	1"	1"
ME850SS-8/6	1"	3/4"
ME850SS-10/8	1-1/4"	1"

## GROUNDING STUD

Designed to help prevent static electricity from being generated due to friction from the pump. In some cases static electricity can build-up enough to create an ignition source and cause an explosion.



Part No.	Thread
ME4H	3/8"-16

## SMART INTERLOCK TECHNOLOGY

Designed to prevent a vehicle from being operated while the hose end delivery valve, loading line or wheel chocks are in use. The smart interlock technology connects directly to the Allison Automatic Transmission through the "Auxiliary Function Range Inhibit" or braking system for manual transmission vehicles. This revolutionary system incorporates the industry's best and most durable sensor, TURCK - which is backed with a lifetime product warranty.

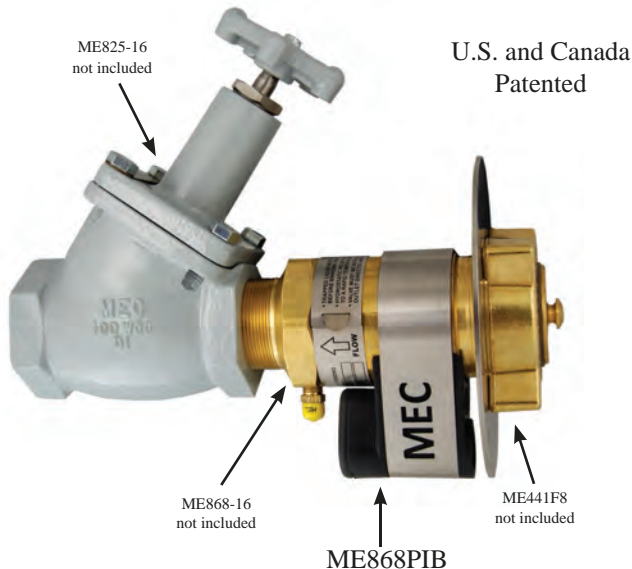

### MEC SMART INTERLOCK TECHNOLOGY FEATURES

- "Potted" TURCK proximity switch for maximum weather resistance and security against vibration
- Supplied with water tight conduit and necessary wiring hardware to reach 5' below deck with water tight receptacle plug

### SENSOR BRACKET ASSEMBLY FEATURES

- Smart interlock technology
- Molded urethane sensor body housing for durability and maximum sensor protection
- Stainless steel all weather mounting band and hardware



# SMART INTERLOCK TECHNOLOGY

TRUCK & PLANT EQUIPMENT



ME200PIBK



ME890PIB



ME217PIB

Smart Interlock Technology



MEP801PIH  
ME800  
Not Included



MEP801PIK

Part No.	Description	Temperature Range	Accessories
ME200PIB	Sensor Bracket Assembly for ME200 Wheel Chocks	-20° to +160° F.	ME200EXT (Standoff Extension Kit)
ME200PIBK	Sensor Bracket Assembly with ME200 Wheel Chocks	-20° to +160° F.	
ME217PIB	Sensor Bracket Assembly for ME217 Series	-20° to +160° F.	MEP801PC/20 (20' Proximity Cable) MEP801PC/30 (30' Proximity Cable) Includes Water Tight Receptacle Plug
ME503PIB	Sensor Bracket Assembly for ME503-16 & ME252-16	-20° to +160° F.	
ME807PIB	Sensor Bracket Assembly for ME807 Series	-20° to +160° F.	
ME808PIB	Sensor Bracket Assembly for ME808 Series	-20° to +160° F.	
ME868PIB	Sensor Bracket Assembly for ME868 Valve Series	-20° to +160° F.	
MEP801PIH	Sensor Assembly with MEP801 Hose End Valve Holster	-20° to +160° F.	
MEP802PIH	Holster W/Proximity Interlock Sensor Assembly with All Weather Hood	-20° to +160° F.	
MEP804PIH	Bobtail Quick-Jaw Hose End Valve Holster w/ Proximity Interlock Sensor Assembly	-20° to +160° F.	
MEP801PIK	Interlock Retro Fit Kit for MEP801 Hose End Valve Holster	-20° to +160° F.	
MEP801PIKL	Low Temperature Interlock Retro Fit Kit for MEP801 Hose End Valve Holster	-50° to +160° F.	
ME890PIB	Universal Sensor Bracket Assembly for Enclosures	-20° to +160° F.	

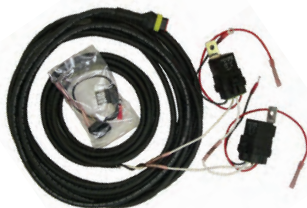

MEP802PCK/20

Smart Interlock Technology Wiring Harness Kits						
Part No.	Description	No. of Relays	LED Power Indicator	Inline Fuse	Cable Length	Accessories
MEP801PCK/20	Wiring Harness Kit	1	Yes	Yes	20'	MEP801PC/20 (20' Proximity Cable)
MEP801PCK/30	Wiring Harness Kit	1	Yes	Yes	30'	MEP801PC/30 (30' Proximity Cable)
MEP802PCK/20	Wiring Harness Kit	2*	Yes	Yes	20'	
MEP802PCK/30	Wiring Harness Kit	2*	Yes	Yes	30'	Includes Water Tight Receptacle Plug
MEP803PCK/30	Wiring Harness Kit	3**	Yes	Yes	30'	

\* One additional cable required (MEP801PC/20 or MEP801PC/30)

\*\* Two additional cables required (MEP801PC/20 or MEP801PC/30)



# QUICK ACTING DISPENSING VALVES

Dispensing valves are designed to be used at the end of a filling hose for bobtail, dispensing system or nurse tank filling operations. These valves have instant full-on flow with the added protection of a quick closing, self-locking handle to prevent accidental opening of the valve during transport.



**ME820 Series**



**ME810 Series**



## FEATURES

- All stainless steel internal components
- Self-locking toggle handle prevents accidental operation
- Durable ductile iron valve body with automotive grade powder coat finish
- Toggle handle and stem assembly rotate 360°
- Stainless steel factory installed vent valve

Part No.		Inlet & Outlet (FNPT)	No. of Side Ports	Accessories		
Angle	Globe			MNPT x 1-3/4 F. Acme Adapter		
				Short Brass	Short Steel*	Extended Steel*
<b>ME810-4</b>	ME820-4	1/2"	1	ME110 ME110C	—	ME635-4 ME635G-4
<b>ME810-6</b>	ME820-6	3/4"	1	ME111 ME111C	ME111S ME111SC	ME635-6 ME635G-6
<b>ME810-8</b>	ME820-8	1"	1	ME112 ME112C	ME112S ME112SC	ME635-8 ME635G-8

\* Rated for LP-Gas & NH<sub>3</sub>



**ME821 Series**



Part No.	Body Style	Inlet & Outlet (FNPT)	No. of Side Ports	Accessories		
				MNPT x 1-3/4 F. Acme Adapter		
				Short Brass	Short Steel*	Extended Steel*
<b>ME821-4</b>	Globe	1/2"	2	ME110 ME110C	—	ME635-4 ME635G-4
<b>ME821-6</b>	Globe	3/4"	2	ME111 ME111C	ME111S ME111SC	ME635-6 ME635G-6
<b>ME821B-4**</b>	Globe	1/2"	2	ME110 ME110C	—	ME635-4 ME635G-4
<b>ME821B-6**</b>	Globe	3/4"	2	ME111 ME111C	ME111S ME111SC	ME635-6 ME635G-6

\* Rated for LP-Gas & NH<sub>3</sub>  
\*\* Includes MEJ400 Brass Vent Valve

## FEATURES

- All stainless steel internal components
- Reduced size and weight for easier handling
- Self-locking toggle handle prevents accidental operation
- Durable ductile iron valve body with automotive grade powder coat finish
- Toggle handle and stem assembly rotate 360°
- Factory installed 1/4" FNPT plugged ports



# HOSE END FILL ADAPTERS

These adapters are intended to be attached to the LP-Gas delivery truck hose outlets. They feature minimal flow restriction which allows for fast delivery while providing an integral check valve to prevent further product loss if the tank fill valve fails to close. In the event the tank fill valve should fail, leave the fill adapter connected to the fill valve and disconnect the filler hose end valve. Then place the filler valve cap onto the fill adapter. The tank fill valve should be repaired immediately.

To increase flow up to 30 percent over standard hose end filler adapters use the ME578 hose end fill adapter. It is a full-flow, manually operated hose end fill adapter where the user controls whether the valve is open or closed, providing maximum protection against product discharge.

## FEATURES

- Integral breakaway feature in the event of truck roll away leaving check intact on tank
- ME570, ME572, ME574, ME578 shortest overall height in the industry allowing adapters to fit inside tank hood
- ME571 has a floating internal seat design which allows check to swivel freely when installed on hose end valve
- ME571H has same features as standard ME571 but with 30% MORE FLOW
- ME578 has a full-port design which allows for full flow
  - Removable shutoff key and key ring supplied
- Extended versions provide an additional 7" for use on underground tanks
  - Prevents pinching or cutting of the delivery hose on the protective tank collar
  - Eliminates dangerous extensions that do not incorporate the appropriate fill check device
  - Eliminates unsafe stacking of multiple fill check adapters to obtain the desirable fill connection height
  - Overall length allows adapter to fit inside protective tank collar
  - Optional heavy duty aluminum handle with a stainless steel 1-3/4" female Acme insert cast into the handle



ME570



ME571



ME572



ME571H



ME574



ME578



ME574EXT



ME572EXTHD

Part No.	Filler Valve F. Acme Connection	Hose End M. Acme Connection	Handle Style	Handle Material	Swivels	Factory Installed Vent Valve	Extended Version OAL**	Additional Keys
ME570	1-3/4"	1-3/4"	Standard	Brass	No	No	—	—
ME571	1-3/4"	1-3/4"	Standard	Brass	Yes*	No	—	—
ME571H	1-3/4"	1-3/4"	Standard	Brass	Yes*	No	—	—
ME572	1-3/4"	1-3/4"	Standard	Brass	Yes	No	—	—
ME572EXT	1-3/4"	1-3/4"	Standard	Brass	Yes	No	7.789"	—
ME572EXTHD	1-3/4"	1-3/4"	Heavy Duty	Cast Aluminum	Yes	No	7.790"	—
ME574	1-3/4"	1-3/4"	Standard	Brass	Yes	Yes	—	—
ME574EXT	1-3/4"	1-3/4"	Standard	Brass	Yes	Yes	7.789"	—
ME574EXTHD	1-3/4"	1-3/4"	Heavy Duty	Cast Aluminum	Yes	Yes	7.790"	—
ME578	1-3/4"	1-3/4"	Standard	Brass	Yes	No	—	ME578-02
ME578C	1-3/4"	1-3/4"	Heavy Duty	Brass	Yes	No	—	ME578-02

\* ME571 and ME571H allows the hose end valve to swivel while connected to the filler hose end adapter  
 \*\* OAL includes free-spinning ACME caps



An excess flow valve is a protective device to help control the discharge of product in the event of complete breakage of pipe lines or hose rupture. However, an excess flow valve can only offer limited protection from gas discharge, because it will only close under those conditions which cause the flow through the valve to exceed its rated closing flow, and even when closed it necessarily allows some “bleed” past the valve.

Excess flow check valves have helped minimize gas loss in many incidents involving breakage of hoses and transfer piping. Thus, they do provide a useful safety function in LP-Gas systems. However, there have also been transfer system accidents where excess flow valves have been ineffective in controlling gas loss due to a variety of conditions and to the inherent limitations of these valves. This bulletin explains the protection excess flow valves can offer, points out conditions which can interfere with that protection, and offers suggestions for effective excess flow valve installation.

If any of the following conditions are present, an excess flow valve is not designed to close and may not provide protection:

1. The piping system restrictions (due to pipe length, branches, reduction in pipe size, or number of other valves) decrease the flow rate to less than the valve’s closing flow. (Valve should be selected by closing flow rating—not just by pipe size).
2. The break or damage to the downstream line is not large enough to allow enough flow to close the valve.
3. A shutoff valve in the line is only partially open and will not allow enough flow to close the excess flow valve.
4. LP-Gas pressure upstream of the excess flow valve, particularly due to low temperature, is not high enough to produce a closing flow rate.
5. Foreign matter is lodged in the valve and prevents closing.
6. A build-up of process material, which may be found in LP-Gas, may occur over a period of time causing the valve to stick open and prevent proper operation.
7. The piping break or damage occurs upstream of an in-line excess flow valve, so the escaping product is not passing through the valve.
8. The flow through the valve is in the wrong direction. (Excess flow valves only respond to flow in one direction.)
9. The excess flow valve has been damaged, or is otherwise not in operating condition.

Excess flow valves have numerous conditions where the valve may not operate correctly and should not be the sole means in the event a pipe is damaged and product needs to be controlled. It is recommended that another shutoff protection device be installed in addition to or instead of an excess flow valve to control the escape of product when a pipe is damaged.

Where excess flow valves are installed,, they should be checked to see that:

1. They are installed in the correct direction—the arrow on the valve indicates the shutoff direction. (Excess flow valves only respond to flow in one direction.)
2. The flow rating on the valve is proper for the installation. The rating must be above the normal system flow, but no higher than necessary, to prevent “nuisance” closing in normal conditions. If the manufacturer’s catalog information is not sufficient, the valve suppliers can provide sizing assistance.
3. To help avoid separating the upstream piping and valve, an in-line excess flow valve is installed to help pipe damage occur downstream.

When the excess flow valves can be examined separate from the line (before the installation or if removed for system maintenance), they should be checked to see that the parts are in good condition and that the poppet can be pushed fully closed.

### Testing of Excess Flow Valves

In order to test an excess flow valve in a piping system, the flow through the valve must exceed the valve’s closing rating. This test should only be attempted by trained personnel familiar with the process. If no one at the facility has experience in proper testing, outside expert help should be obtained. The exact procedure used may vary with the installation, gas discharge exposure, and availability of equipment.

In general, most testing makes use of the fact that excess flow valves are “surge sensitive” and will close quicker under a sudden flow surge than under steady flow. A sufficient surge can often be created by using a quick closing valve to control sudden, momentary flow into a tank or piping section containing very low pressure. An audible click from the excess flow valve (and corresponding stoppage of flow) indicates its closure.

A test involving venting gas to the atmosphere is hazardous and may be impractical or illegal.

Any test of any excess flow valve will not prove that the valve will close in an emergency situation, due to reasons cited before. This test will only check the valve’s condition, and the flow rate sizing for those test conditions.

For additional information on excess flow valves contact your local distributor, Marshall Excelsior and refer to NFPA 58.



# EXCESS FLOW VALVES

## Excelsior-Flange SERIES

Marshall Excelsior offers the **largest closing flow selection** in the industry. These excess flow valves are intended for use in liquid or vapor LP-Gas or NH<sub>3</sub> systems. These valves can be used for filling, withdrawal and vapor equalization in containers or line applications, specifically long lines or branch piping. This product is designed to protect against excessive discharge as a result of a break in the hose or piping system. The excess flow feature is designed to remain closed after activation until the system pressure equalizes on both sides of the shutoff poppet.

The ME883S-16 Series valves feature our new modular **Excelsior-flange** 4 bolt inlet flange design that can be easily adapted to both NPT thread or socket weld type B companion flanges ranging from 1-1/4" to 2" in diameter making it universal to piping sizes within this range. This innovative system allows installers the ability to eliminate unnecessary extra connections as well as possible leak points by integrating a convenient 4 bolt flange union at the valve inlet.

**WARNING:** An excess flow valve will not activate if there is a break or leak downstream of the valve that does not equal or exceed the closing flow of the valve or if the excess flow valve installed exceeds the flow capacity of the system. See the Excess Flow Warning page for more information regarding the use of excess flow devices.

### FEATURES

- All models feature stainless steel stem, spring and valve guide
- Valve body: Ductile Iron / Shutoff poppet assy: zinc plated steel & stainless steel
- Available 2" NPT x 4 Bolt Type A Flange
- All models can be used with LP Gas or NH<sub>3</sub>
- Available in a wide variety of closing flow rates - see chart below



**ME883S-16/105**  
2" NPT x 4 Bolt Flange  
Excess Flow Valve

Part No.	Description	Material	Closing Flow	Mating Flange Type	Weight (lbs.)
ME883S-16/80	Excelsior-Flange 2" MNPT x 4 Bolt Type A Flange Excess Flow	Ductile	80	B	4.23
ME883S-16/105	Excelsior-Flange 2" MNPT x 4 Bolt Type A Flange Excess Flow	Ductile	105	B	4.23
ME883S-16/114	Excelsior-Flange 2" MNPT x 4 Bolt Type A Flange Excess Flow	Ductile	114	B	4.23
ME883S-16/140	Excelsior-Flange 2" MNPT x 4 Bolt Type A Flange Excess Flow	Ductile	140	B	4.23
Accessories					
Part No.	Description				
MEP173	4 Bolt Type A Flange Valve Installation Tool w/ 1" Square Drive				
MEP183-102	Replacement Torque Posts				

**\*\*WARNING** - Reducing outlet pipe size below 2" nominal diameter could result in excess flow feature failing to close as designed  
Liquid Butane Capacity = Flow Rate x .94  
Liquid Anhydrous Ammonia Capacity = Flow Rate x .90

*"Throw away that pipe wrench for  
**GOOD!**"*



**MEP873**



# EXCESS FLOW VALVES

Marshall Excelsior offers the Largest Closing Flow Selection in the industry. These excess flow valves are intended for use in liquid or vapor LP-Gas or NH<sub>3</sub> systems. These valves can be used for filling, withdrawal and vapor equalization in containers or line applications, specifically long lines or branch piping. This product is designed to protect against excessive discharge as a result of a break in the hose or piping system. The excess flow feature is designed to remain closed after activation until the system pressure equalizes on both sides of the shutoff poppet.

**NOTE:** Intended for direct installation into pressure vessels and/or piping.

**WARNING:** An excess flow valve will not activate if there is a break or leak downstream of the valve that does not equal or exceed the closing flow of the valve or if the excess flow valve installed exceeds the flow capacity of the system. See the Excess Flow Warning page for more information regarding the use of excess flow devices.

## FEATURES

- All stainless steel internal components
- Integral breakaway feature leaves valve assembly intact with internal hex broach for easy removal



ME880 Series



ME880S Series



ME882S Series

Part No.			Inlet MNPT	Outlet FNPT	Closing Flow GPM Propane
Brass	Steel*	Stainless Steel*			
ME880-4/1.8	—	—	1/4"	1/4"	1.8
ME880-6/4.6	ME880S-6/4.6	ME880SS-6/4.6	3/4"	3/4"	4.6
ME880-6/14	ME880S-6/14	ME880SS-6/14	3/4"	3/4"	14
ME880-6/17	ME880S-6/17	ME880SS-6/17	3/4"	3/4"	17
ME880-6/22	ME880S-6/22	ME880SS-6/22	3/4"	3/4"	22
ME880-6/28	ME880S-6/28	ME880SS-6/28	3/4"	3/4"	28
ME880-10/32	ME880S-10/32	ME880SS-10/32	1-1/4"	1-1/4"	32
ME880-10/42	ME880S-10/42	ME880SS-10/42	1-1/4"	1-1/4"	42
ME880-12/95	—	—	1-1/2"	1-1/2"	95
ME880-16/80	ME880S-16/80	ME880SS-16/80	2"	2"	80
ME880-16/105	ME880S-16/105	ME880SS-16/105	2"	2"	105
ME880-16/114	ME880S-16/114	ME880SS-16/114	2"	2"	114
ME880-16/140	ME880S-16/140	ME880SS-16/140	2"	2"	140
—	ME882S-16/80	—	2"	2" MNPT	80
—	ME882S-16/105	—	2"	2" MNPT	105
—	ME882S-16/114	—	2"	2" MNPT	114
—	ME882S-16/140	—	2"	2"	140
—	ME880S-24/265	—	3"	3"	265
—	ME880S-24/350	—	3"	3"	350
—	ME882S-24/265	—	3"	3" MNPT/2" FNPT	265
—	ME882S-24/350	—	3"	3" MNPT/2" FNPT	350

Liquid Butane Capacity = Flow Rate x .94

Liquid Anhydrous Ammonia Capacity = Flow Rate x .90





# BACK CHECK VALVES

## High Flow Excelsa-Flange SERIES

The ME873S Series valves feature our new modular Excelsa-Flange 4 bolt inlet flange design that can be easily adapted to both NPT thread or socket weld type B companion flanges ranging from 1-1/4" to 2" in diameter making it universal to piping sizes within this range. This innovative system allows installers the ability to eliminate unnecessary extra connections as well as possible leak points by integrating a convenient 4 bolt flange union at the valve inlet. Marshall Excelsior High Flow back check valves provide back flow protection to container openings or liquid lines where flow is intended for one direction. The valve is normally held closed until pressure activates the valve when flow is directed into piping or containers causing the back check to open. When flow stops or reverses, the check returns to the closed position. All MEC High Flow Back Check valves are supplied with o-ring soft seats, which can be removed for metal to metal seating. Also available with permanently bonded on main valve seals (SBN).



**ME873S-24**  
SHOWN WITH O-RING REMOVED  
METAL TO METAL



**ME873SBN-24**  
(SBN - BONDED SEAT)



**ME873S-16**  
SHOWN WITH O-RING REMOVED  
METAL TO METAL

### FEATURES

- Universal seat - Remove O-ring seal to create metal to metal seating surface or (SBN) bonded seat
- Up to **20% MORE FLOW** than nearest competitor
- Maximum product flow achieved by full port and stem travel design
- All models feature stainless steel stem, spring and valve guide
- Valve body: Ductile Iron / Shutoff poppet assy: steel & stainless steel
- Available in 2" NPT and 3" NPT x 4 Bolt Type A Flange
- All models can be used with LP Gas or NH<sub>3</sub>
- Universal 4 bolt flange inlet type A

MEC Excelsa-Flange High Flow Back Check Valves					
Part No.	Description	Material	Propane Flow 10 PSIG Pressure Differential	Mating Flange Type	Weight (lbs.)
ME873S-16	Excelsa-Flange™ 2" MNPT x 4 Bolt Type A Flange Back Check Valve	Ductile	187	B	4.2
ME873SBN-16	Excelsa-Flange™ 2" MNPT x 4 Bolt Type A Flange Back Check Valve (SBN) Bonded Seat	Ductile	187	B	4.2
ME873S-24	Excelsa-Flange™ 3" MNPT x 4 Bolt Type A Flange Back Check Valve	Ductile	449	B	7.0
ME873SBN-24	Excelsa-Flange™ 3" MNPT x 4 Bolt Type A Flange Back Check Valve (SBN) Bonded Seat	Ductile	449	B	7.1

Liquid Butane Capacity = Flow Rate x .94

Liquid Anhydrous Ammonia Capacity = Flow Rate x .90

Replacements o-rings available upon request. See Replacement Parts section.



# BACK CHECK VALVE - SOCKET WELD

High Flow  **Excelsa-Flange** SERIES

These **Excelsa-Flange** High Flow Socket Weld Back Check valves lead the industry with up to **20% More Flow** than the nearest competitor. Back check valves provide flow protection to container openings or liquid lines where flow is intended for one direction. The valve is normally closed until pressure activates the valve when flow is directed into piping or containers causing the back check to open. When flow stops or reverses, the check returns to the closed position.

Featuring socket weld connection points, these valves are ideally suited for inline applications where welded piping construction is desired, such as in a bobtail spray fill / bypass return combination line. A perfect companion to the MEC **Excelsa-Flange** product line. Only available with metal-to-metal seat due to high heat associated with socket weld construction/installation.



## FEATURES

- Up to 20% More Flow than nearest competitor
- Maximum flow achieved by full port and increased stem travel design
- Integral breakaway feature leaves valve assembly intact
- All stainless steel internal components
- High temperature Inconel spring withstands heat from welding

Part No.	Inlet Socket Weld	Outlet Socket Weld	Propane Flow @ 10 PSIG Pressure Differential	Weight (lbs.)
ME870SW-16	2" Female	2" Male	189	1.77
* Rated for LP-Gas & NH <sub>3</sub>				

Liquid Butane Capacity = Flow Rate x .94

Liquid Anhydrous Ammonia Capacity = Flow Rate x .90

# High Flow BACK CHECK VALVES

These back check flow valves lead the industry with up to **20% More Flow** than the nearest competitor. Back check valves provide flow protection to container openings or liquid lines where flow is intended for one direction. The valve is normally closed until pressure activates the valve when flow is directed into piping or containers causing the back check to open. When flow stops or reverses, the check returns to the closed position.

These valves come with dual seating capabilities or an optional bonded soft seat on 2 and 3" models. With the dual seating capabilities, the factory installed O-ring provides a leak-free, soft seat seal which enables repair and maintenance to be done on depressurized plumbing. Remove the O-ring to allow metal-to-metal seating with a minimal leak seal to restrict flow in case of a break in the line. Note: Leaving the O-ring soft seat installed on the valve will require a minimum of 15 psig pressure differential between the transfer line and container to unseat the valve and allow it to fully open.

## FEATURES

- Up to **20% More Flow** than nearest competitor
- Maximum flow achieved by full port and increased stem travel design
- Integral breakaway feature leaves valve assembly intact with internal hex broach for easy removal
- All stainless steel internal components
- Dual purpose seat reduces inventory from 2 to 1



**ME870 Series**  
Shown with  
O-Ring Soft Seat



**ME870S Series**  
Shown with O-Ring  
Removed for  
Metal-to-Metal Seat

High Flow Back Check Valves					
Part No.			Inlet FNPT	Outlet MNPT	Propane Flow at 10 PSIG Pressure Differential
Brass	Steel*	Stainless Steel*			
ME870-6	ME870S-6	ME870SS-6	3/4"	3/4"	24
ME870-10	ME870S-10	ME870SS-10	1-1/4"	1-1/4"	61
ME870-12	—	—	1-1/2"	1/2"	112
ME870-16	ME870S-16	ME870SS-16	2"	2"	187
—	ME872S-16	—	2" MNPT	2"	187
—	ME870S-24	—	3"	3"	449
—	ME872S-24	—	2" FNPT/ 3" MNPT	3"	449
—	ME872S-24SP**	—	2" FNPT	3"	449

\* Rated for LP-Gas & NH<sub>3</sub>  
\*\* Includes removable o-ring



**ME872S-16**

High Flow Back Check Valves w/ Bonded Soft Seat					
Part No.			Inlet FNPT	Outlet MNPT	Propane Flow at 10 PSIG Pressure Differential
Brass	Steel*	Stainless Steel*			
—	ME870SBN-10	—	1-1/4"	1-1/4"	61
—	ME870SBN-16	—	2"	2"	187
—	ME872SBN-16	—	2" MNPT	2"	187
—	ME870SBN-24**	—	3"	3"	449
—	ME872SBN-24	—	2" FNPT/ 3" MNPT	3"	449
—	ME872SBN-24SP	—	2" FNPT	3"	449

\* Rated for LP-Gas & NH<sub>3</sub>  
\*\* Use for high flow transport applications



**ME870SBN-24**  
Shown with Bonded  
Soft Seat

Liquid Butane Capacity = Flow Rate x .94  
Liquid Anhydrous Ammonia Capacity = Flow Rate x .90



# High Flow **DOUBLE BACK CHECK FILL VALVES**

Marshall Excelsior High Flow Double Back Check Valves provide back flow protection to container openings or liquid lines where flow is intended in one direction. The valve is normally held closed until pressure activates the valve when flow is directed into piping or containers causing the double back check to open. When flow stops or reverses, both checks return to the closed position. All MEC High Flow Double Back Check Valves are supplied with the correct ACME cap and chain assembly, as well as factory installed hydrostatic relief protection.

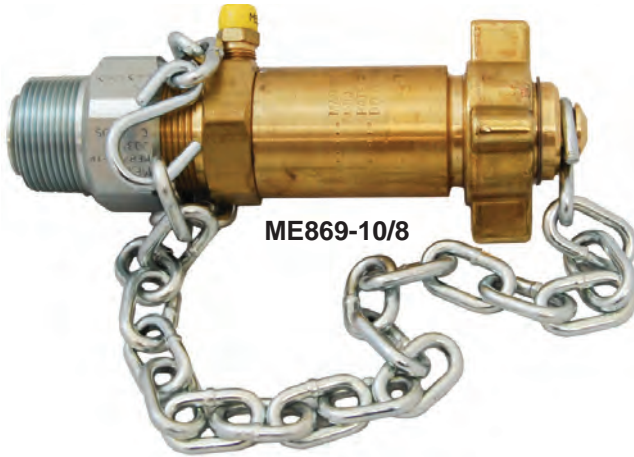

## FEATURES

- Primary Seat - Creates metal to metal seating surface
- Secondary Seat - bonded nitrile soft seat for a leak free seal
- Up to **20% More Flow** than nearest competitor
- Maximum product flow achieved by full port and stem travel design
- All models feature stainless steel stem, spring and valve guide in body check assembly
- Built in hydrostatic relief valve
- For use with **LP Gas ONLY**



Part No.	Description	Propane Flow		
		Differential Pressure		
		10 PSI	25 PSI	50 PSI
ME869-10/10	Double Back Check Valve 1-1/4" MNPT x 2-1/4" M. Acme	75	116	157
ME869-10/8	Double Back Check Valve 1-1/4" MNPT x 1-3/4" M. Acme	51	85	124
ME869-16	Double Back Check Valve 2" MNPT x 3-1/4" M. Acme	195	296	416
ME869-24	Double Back Check Valve 3" MNPT x 3-1/4" M. Acme	347	519	718



## Excelsior-Flange 1-1/4" MNPT x 4 BOLT FLANGE

The ME991-10 Series valves feature our new modular **Excelsior-Flange** 4 bolt outlet flange design that can be easily adapted to both NTP thread or socket weld type B companion flanges (ME842 & ME843 Series) ranging from 1-1/4" to 2" in diameter making it universal to piping sizes within this range. This innovative system allows installers the ability to eliminate unnecessary connections as well as possible leak points by integrating a convenient 4 bolt flange union at the valve outlet. Intended for use on bobtail trucks and storage tanks with 1-1/4" threaded connections in directional or bi-directional flow applications. Provides both manual shut-down as well as excess flow closing in the event of the piping being separated from the valve. Can be equipped with manual latch, pneumatic or rotary actuator, open/ closing devices. All valve models are equipped with a break-away feature in the cast body which permits the piping to shear off in the event of side impact, leaving the valve poppet intact and protecting the tank from catastrophic product loss. FOR LIQUID OR VAPOR SERVICE APPLICATIONS.



1-1/4" MNPT x 4 Bolt Type A Flanged Internal Valve



### FEATURES

- Durable 316 SS body
- All stainless internal component construction
- Precision machined hard coated stem
- Fully retained nitrile seat disc
- Large variety of excess flow closing values
- Roller cam actuation
- Industry's fastest bleed time
- Removable data plate
- Industry's easiest valve to service
- Standard construction utilizes nitrile seals
- Available with Neoprene, Viton®, or Kalrez® seals
- LISTED for LPG & NH<sub>3</sub> service
- Rulon™ bearing on stub shaft
- 4 Bolt universal outlet flange for built in union joint

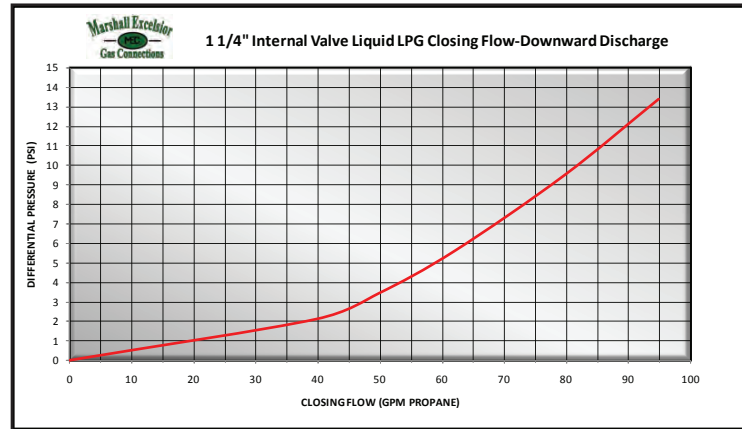

"X"	1-1/4" Valve Liquid Closing Flow Values
35	35 GPM LPG Closing Flow
55	55 GPM LPG Closing Flow
85	85 GPM LPG Closing Flow
* For NH <sub>3</sub> multiply GPM by .90	

Part No. *	Description	Mating Flange Type	Weight (lbs.)
ME991-10-"X"	Excelsior-Flange™ 1-1/4" MNPT x 4 Bolt Type A Flange Internal Valve - Only	B	5.7
ME991A-10-"X"	Excelsior-Flange™ 1-1/4" MNPT x 4 Bolt Type A Flange Internal Valve - w/Pneumatic Actuator	B	9.5
ME991AR-10-"X"	Excelsior-Flange™ 1-1/4" MNPT x 4 Bolt Type A Flange Internal Valve - w/Rotary Actuator	B	10.2
ME991M-10-"X"	Excelsior-Flange™ 1-1/4" MNPT x 4 Bolt Type A Flange Internal Valve - w/Manual Latch	B	5.7

\* Note: Indicate desired excess flow closing value when ordering - see chart for values  
 i.e. ME991-10-85 (85 GPM)  
 To order Kalrez® add "K" for Kalrez® after the prefix part number i.e. ME991K-10-35  
 To order Neoprene add "N" for Neoprene after the prefix part number i.e. ME991N-10-35  
 To order Viton® add "V" for Viton® after the prefix part number i.e. ME991V-10-35

Viton® and Kalrez® are trademarks of DuPont Performance Elastomers.



## 1-1/4" THREADED



ME990M-10 Series

Intended for use on bobtail trucks and storage tanks with 1-1/4" threaded connections in directional or bi-directional flow applications. Provides both manual shut-down as well as excess flow closing in the event of the piping being separated from the valve. Can be equipped with manual latch, pneumatic or rotary actuator, open/ closing devices. All valve models are equipped with a break-away feature in the cast body which permits the piping to shear off in the event of side impact, leaving the valve poppet intact and protecting the tank from catastrophic product loss. For liquid or vapor service applications.

### FEATURES

- Standardized 316 stainless steel cast body for maximum durability and corrosion resistance
- All stainless internal component construction
- Hexagonal installation flats to fit standard 2-3/8" hex socket wrench
- Precision machined hard coated stem
- Fully retained Nitrile seat disc
- Large variety of excess flow closing values
- Roller cam actuation
- Industry's fastest bleed time
- Removable data plate
- Industry's easiest valve to service
- Standard construction utilizes Nitrile seals
- Available with Neoprene, Viton®, or Kalrez® seals
- LISTED for LPG & NH<sub>3</sub> service
- Rulon™ bearing on stub shaft

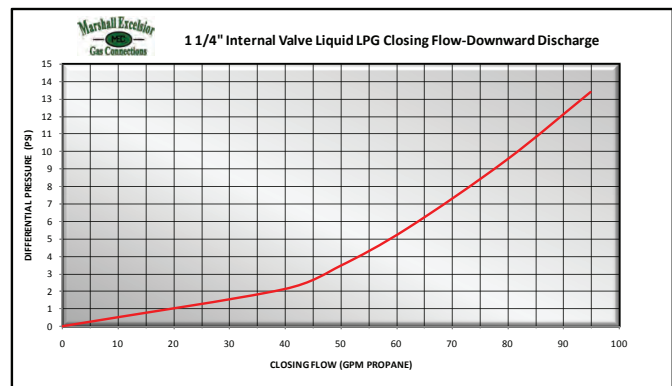

"X"	1-1/4" Valve Liquid Closing Flow Values
35	35 GPM LPG Closing Flow
55	55 GPM LPG Closing Flow
85	85 GPM LPG Closing Flow

\* For NH<sub>3</sub> multiply GPM by .90

Part No. *	Description
ME990-10-"X"	Excelerator™ 1-1/4" MNPT x 1-1/4" FNPT Internal Valve - Only
ME990A-10-"X"	Excelerator™ 1-1/4" MNPT x 1-1/4" FNPT Internal Valve - with Pneumatic Actuator
ME990AR-10-"X"	Excelerator™ 1-1/4" MNPT x 1-1/4" FNPT Internal Valve - with Rotary Actuator
ME990M-10-"X"	Excelerator™ 1-1/4" MNPT x 1-1/4" FNPT Internal Valve - with Manual Latch

\*Note: Indicate desired excess flow closing value when ordering - see chart for values  
 i.e. ME990-10-85 (85 GPM)  
 To order Kalrez® add "K" for Kalrez® after the prefix part number i.e. ME990K-10-35  
 To order Neoprene add "N" for Neoprene after the prefix part number i.e. ME990N-10-35  
 To order Viton® add "V" for Viton® after the prefix part number i.e. ME990V-10-35

Viton® and Kalrez® are trademarks of DuPont Performance Elastomers.



## 1-1/4" THREADED TEE BODY

Intended for use on bobtail trucks and storage tanks with 1-1/4" threaded connections in directional or bi-directional flow applications. Provides both manual shut-down as well as excess flow closing in the event of the piping being seperated from the valve. Can be equipped with manual latch, pneumatic or rotary actuator, open/ closing devices. All valve models are equipped with a break-away feature in the cast body which permits the piping to shear off in the event of side impact, leaving the valve poppet intact and protecting the tank from catastrophic product loss. The tee body features an additional FNPT side discharge port . For liquid or vapor service applications.

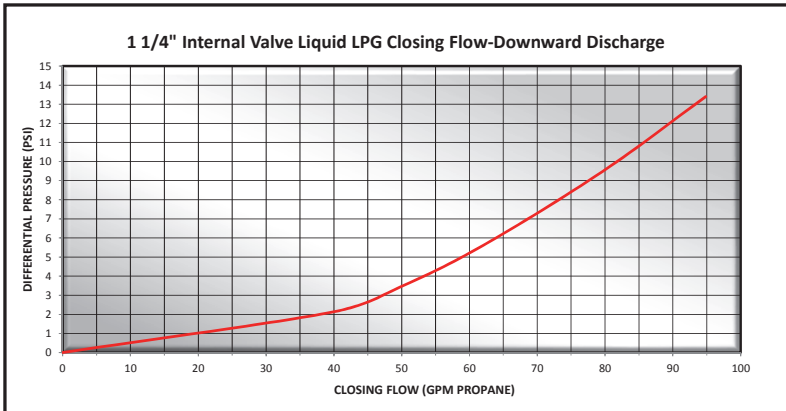

**ME992-10**  
1-1/4" NTP Tee Body Internal Valve



### FEATURES

- Standardized 316 stainless steel cast body for maximum durability and corrosion resistance
- All stainless internal component construction
- Precision machined hard coated stem
- Fully retained nitrile seat disc
- Large variety of excess flow closing values
- Roller cam actuation
- Industry's fastest bleed time
- Removable data plate
- Industry's easiest valve to service
- Standard construction utilizes nitrile seals
- Available with Neoprene, Viton®, or Kalrez® seals
- LISTED for LPG & NH<sub>3</sub> service
- Rulon™ bearings on stem and stub shafts

"X"	1-1/4" Valve Liquid Closing Flow Values
35	35 GPM LPG Closing Flow
55	55 GPM LPG Closing Flow
85	85 GPM LPG Closing Flow
* For NH <sub>3</sub> multiply GPM by .90	

MEC Excelerator™ 1-1/4" Threaded Tee Body Internal Valves	
Part No. *	Description
ME992-10-"X"	Excelerator™ 1-1/4" MNPT x 1-1/4" FNPT Internal Valve - Only
ME992A-10-"X"	Excelerator™ 1-1/4" MNPT x 1-1/4" FNPT Internal Valve - with Pnuematic Actuator
ME992AR-10-"X"	Excelerator™ 1-1/4" MNPT x 1-1/4" FNPT Internal Valve - with Rotary Actuator
ME992M-10-"X"	Excelerator™ 1-1/4" MNPT x 1-1/4" FNPT Internal Valve - with Manual Latch
* Note: Indicate desired excess flow closing value when ordering - see chart for values i.e. ME992-10-85 (85 GPM) To order Kalrez® add "K" for Kalrez® after the prefix part number i.e. ME992K-10-35 To order Neoprene add "N" for Neoprene after the prefix part number i.e. ME992N-10-35 To order Viton® add "V" for Viton® after the prefix part number i.e. ME992V-10-35	

Viton® and Kalrez® are trademarks of DuPont Performance Elastomers.



## 2" & 3" THREADED

Intended for use on transport trucks and large storage tanks with 2" or 3" threaded connections in directional or bi-directional flow applications. Provides both manual shut-down and excess flow closing in the event of the piping being separated from the valve. Can be equipped with manual latch, pneumatic or rotary actuator open/ closing devices. All valve models are equipped with a break-away feature in the cast body which permits the piping to shear off in the event of side impact, leaving the valve poppet intact and protecting the tank from catastrophic product loss. For liquid or vapor service applications

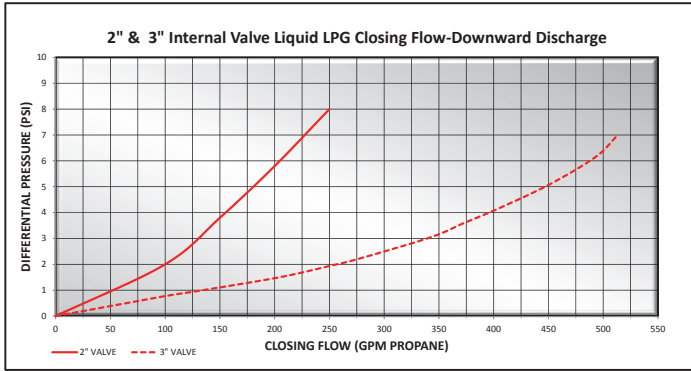

### FEATURES

- Durable ductile body with cadmium surface plating
- All stainless internal component construction
- One piece threaded packing gland
- Precision machined hard coated stem
- Fully retained Nitrile seat disc
- Largest variety of excess flow closing values
- Roller cam actuation
- Industry's fastest bleed time
- Removable data plate
- Industry's easiest valve to service
- Standard construction utilizes Nitrile seals
- Available with Neoprene, Viton®, or Kalrez® seals
- LISTED for LPG & NH<sub>3</sub> service
- Rulon™ bearings on stem and stub shafts

"X"	2" Valve Liquid Closing Flow Values
110	110 GPM LPG Closing Flow
160	160 GPM LPG Closing Flow
260	260 GPM LPG Closing Flow

"X"	3" Valve Liquid Closing Flow Values
175	175 GPM LPG Closing Flow
250	250 GPM LPG Closing Flow
300	300 GPM LPG Closing Flow
375	375 GPM LPG Closing Flow
400	400 GPM LPG Closing Flow
475	475 GPM LPG Closing Flow
500	500 GPM LPG Closing Flow

MEC Excelerator™ 2" & 3" Threaded Internal Valves	
Part No. *	Description
ME990-16-"X"	Excelerator™ 2" MNPT x 2" FNPT Internal Valve - Only
ME990A-16-"X"	Excelerator™ 2" MNPT x 2" FNPT Internal Valve - with Pneumatic Actuator
ME990AR-16-"X"	Excelerator™ 2" MNPT x 2" FNPT Internal Valve - with Rotary Actuator
ME990M-16-"X"	Excelerator™ 2" MNPT x 2" FNPT Internal Valve - with Manual Latch
ME990-24-"X"	Excelerator™ 3" MNPT x 3" FNPT Internal Valve - Only
ME990A-24-"X"	Excelerator™ 3" MNPT x 3" FNPT Internal Valve - with Pneumatic Actuator
ME990AR-24-"X"	Excelerator™ 3" MNPT x 3" FNPT Internal Valve - with Rotary Actuator
ME990M-24-"X"	Excelerator™ 3" MNPT x 3" FNPT Internal Valve - with Manual Latch

\*Note: Indicate desired excess flow closing value when ordering - see chart for values  
i.e. ME990-24-250 (250 GPM)  
Note: Available in all Stainless Steel Construction  
To order Kalrez® add "K" for Kalrez® after the prefix part number i.e. ME990K-16-160  
To order Neoprene add "N" for Neoprene after the prefix part number i.e. ME990N-16-160  
To order Viton® add "V" for Viton® after the prefix part number i.e. ME990V-16-160

Viton® and Kalrez® are trademarks of DuPont Performance Elastomers.





## 2" & 3" THREADED TEE BODY

Intended for use on transport trucks and large storage tanks with 2" or 3" threaded connections in directional or bi-directional flow applications. Provides both manual shut-down and excess flow closing in the event of the piping being separated from the valve. Can be equipped with manual latch, pneumatic or rotary actuator open/ closing devices. All valve models are equipped with a break-away feature in the cast body which permits the piping to shear off in the event of side impact, leaving the valve poppet intact and protecting the tank from catastrophic product loss. The tee body features an additional FNPT side discharge port. For liquid or vapor service applications.

### FEATURES

- Durable ductile body with cadmium surface plating
- All stainless internal component construction
- One piece threaded packing gland
- Precision machined hard coated stem
- Fully retained nitrile seat disc
- Largest variety of excess flow closing values
- Roller cam actuation
- Industry's fastest bleed time
- Removable data plate
- Industry's easiest valve to service
- Standard construction utilizes nitrile seals
- Available with Neoprene, Viton®, or Kalrez® seals
-  LISTED for LPG & NH<sub>3</sub> service
- Rulon™ bearings on stem and stub shafts



**ME992M-16**  
2" NTP Tee Body Internal Valve w/ Manual Latch

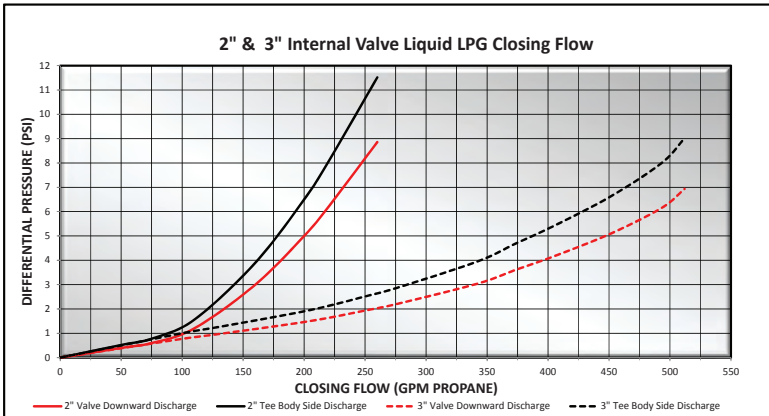

"X"	2" Valve Liquid Closing Flow Values
110	110 GPM LPG Closing Flow
160	160 GPM LPG Closing Flow
260	260 GPM LPG Closing Flow

"X"	3" Valve Liquid Closing Flow Values
175	175 GPM LPG Closing Flow
250	250 GPM LPG Closing Flow
300	300 GPM LPG Closing Flow
375	375 GPM LPG Closing Flow
475	475 GPM LPG Closing Flow
500	500 GPM LPG Closing Flow

For NH<sub>3</sub> multiply GPM by .90  
Side discharge increases differential to close by approx. 2 PSIG

Part No. *	Description
ME992-16-"X"	Excelsior™ 2" MNPT x 2" FNPT Tee Body Internal Valve - Only
ME992A-16-"X"	Excelsior™ 2" MNPT x 2" FNPT Tee Body Internal Valve - with Pneumatic Actuator
ME992AR-16-"X"	Excelsior™ 2" MNPT x 2" FNPT Tee Body Internal Valve - with Rotary Actuator
ME992M-16-"X"	Excelsior™ 2" MNPT x 2" FNPT Tee Body Internal Valve - with Manual Latch
ME992-24-"X"	Excelsior™ 3" MNPT x 3" FNPT Tee Body Internal Valve - Only
ME992A-24-"X"	Excelsior™ 3" MNPT x 3" FNPT Tee Body Internal Valve - with Pneumatic Actuator
ME992AR-24-"X"	Excelsior™ 3" MNPT x 3" FNPT Tee Body Internal Valve - with Rotary Actuator
ME992M-24-"X"	Excelsior™ 3" MNPT x 3" FNPT Tee Body Internal Valve - with Manual Latch

\*Note: Indicate desired excess flow closing value when ordering - see chart for values - i.e. ME992-24-250 (250 GPM)  
To order Kalrez® add "K" for Kalrez® after the prefix part number i.e. ME992K-16-160  
To order Neoprene add "N" for Neoprene after the prefix part number i.e. ME992N-16-160  
To order Viton® add "V" for Viton® after the prefix part number i.e. ME992V-16-160

Viton® and Kalrez® are trademarks of DuPont Performance Elastomers.



## 2" & 3" MNPT x 300 LB FLANGED

Intended for use on transport trucks and large storage tanks with 2" or 3" threaded connections in directional or bi-directional flow applications. The ME991-16 & ME991-24 Series feature standard 300# outlet flanges for fast reliable piping connections downstream of the tank. Ideally suited for existing tanks with NPT threaded couplings but downstream welded piping is desirable. Provides both manual shut-down and excess flow closing in the event of the piping being separated from the valve. Can be equipped with manual latch, pneumatic or rotary actuator open/ closing devices. All valve models are equipped with a break-away feature in the cast body which permits the piping to shear off in the event of side impact, leaving the valve poppet intact and protecting the tank from catastrophic product loss. For liquid or vapor service applications.



**ME991-24**  
3" MNPT x 3"- 300#  
Flanged Internal Valve

**ME991-16**  
2" MNPT x 2"- 300#  
Flange Internal Valve

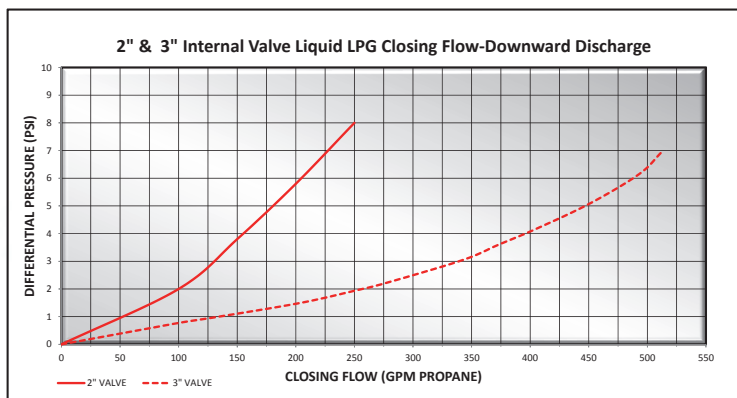

### FEATURES

- Durable ductile body with cadmium surface plating
- All stainless internal component construction
- One piece threaded packing gland
- Precision machined hard coated stem
- Fully retained nitrile seat disc
- Largest variety of excess flow closing values
- Roller cam actuation
- Industry's fastest bleed time
- Removable data plate
- Industry's easiest valve to service
- Standard construction utilizes nitrile seals
- Available with Neoprene, Viton®, or Kalrez® seals
- LISTED for LPG & NH<sub>3</sub> service
- Rulon™ bearings on stem and stub shafts Rulon™
- Xylan™ coated corrosion resistant mounting studs & gaskets included

"X"	2" Valve Liquid Closing Flow Values
110	110 GPM LPG Closing Flow
160	160 GPM LPG Closing Flow
260	260 GPM LPG Closing Flow

"X"	3" Valve Liquid Closing Flow Values
175	175 GPM LPG Closing Flow
250	250 GPM LPG Closing Flow
300	300 GPM LPG Closing Flow
375	375 GPM LPG Closing Flow
475	475 GPM LPG Closing Flow
500	500 GPM LPG Closing Flow

\* For NH<sub>3</sub> multiply GPM by .90

Part No. *	Description
ME991-16-"X"	Excelerator™ 2" MNPT x 2"-300# Flange Internal Valve - Only
ME991A-16-"X"	Excelerator™ 2" MNPT x 2"-300# Flange Internal Valve - with Pneumatic Actuator
ME991AR-16-"X"	Excelerator™ 2" MNPT x 2"-300# Flange Internal Valve - with Rotary Actuator
ME991M-16-"X"	Excelerator™ 2" MNPT x 2"-300# Flange Internal Valve - with Manual Latch
ME991-24-"X"	Excelerator™ 3" MNPT x 3"-300# Flange Internal Valve - Only
ME991A-24-"X"	Excelerator™ 3" MNPT x 3"-300# Flange Internal Valve - with Pneumatic Actuator
ME991AR-24-"X"	Excelerator™ 3" MNPT x 3"-300# Flange Internal Valve - with Rotary Actuator
ME991M-24-"X"	Excelerator™ 3" MNPT x 3"-300# Flange Internal Valve - with Manual Latch

\* Note: Indicate desired excess flow closing value when ordering - see chart for values  
i.e. ME991-24-250 (250 GPM)  
To order Kalrez® add "K" for Kalrez® after the prefix part number i.e. ME991K-16-160  
To order Neoprene add "N" for Neoprene after the prefix part number i.e. ME991N-16-160  
To order Viton® add "V" for Viton® after the prefix part number i.e. ME991V-16-160

Viton® and Kalrez® are trademarks of DuPont Performance Elastomers.



## Excelsior-Flange 2"- 300 LB X 2" - 8 BOLT COMPANION FLANGE

The ME994S-2F series valves feature our new modular Excelsior-Flange 2"-8 bolt outlet flange design that can be easily adapted to either 2" NPT or socket weld companion flanges (MEP994S-2F-2SW) making it universal to either piping construction.

### FEATURES

- Durable steel body with cadmium surface plating
- Universal 2"-8 bolt outlet flange connection for threaded or welded piping
- Universal 2"-8 bolt outlet flange provides a built-in union joint for easy servicing
- All stainless internal component construction
- One piece threaded packing gland
- Precision machined hard coated stem & stem guide
- Fully retained nitrile seat disc
- Largest variety of excess flow closing values
- Corrosion resistant sleeved flange bolt holes
- Xylan coated corrosion resistant mounting studs
- Roller cam actuation
- Industry's fastest bleed time
- Removable data plate
- Industry's easiest valve to service
- Standard construction utilizes nitrile seals
- Available with Neoprene, Viton®, or Kalrez® seals
- Available with 316 Stainless Steel bodies
- UL LISTED for LPG & NH<sub>3</sub> service
- Rulon™ bearings on stem and stub shafts
- Fits standard 2" - 300# flanged tank openings



X	2" Valve Liquid Closing Flow Values
110	110 GPM LPG Closing Flow
160	160 GPM LPG Closing Flow
260	260 GPM LPG Closing Flow

\* For NH<sub>3</sub> Multiply GPM by .90

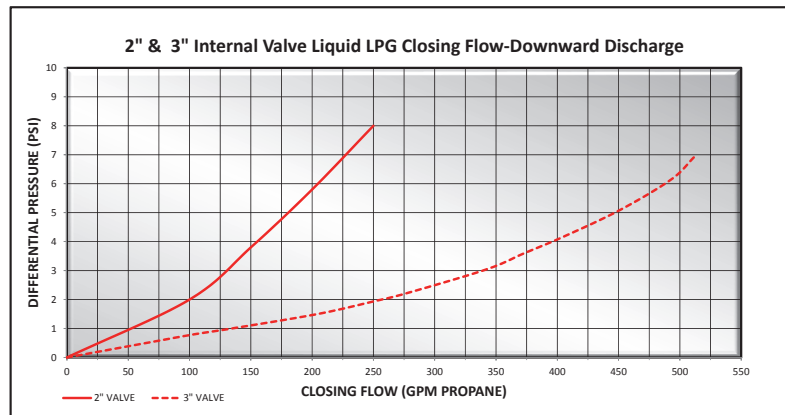

Part No. *	Description	Weight (lbs.)
ME994S-2F-16-"X"	Excelsior™ 2"-300 lb. Modified Single Flange x 2"-8 Bolt Flange Internal Valve - Only	21.6
ME994SA-2F-16-"X"	Excelsior™ 2"-300 lb. Modified Single Flange x 2"-8 Bolt Flange Internal Valve - with Pneumatic Actuator	35.5
ME994SAR-2F-16-"X"	Excelsior™ 2"-300 lb. Modified Single Flange x 2"-8 Bolt Flange Internal Valve - with Rotary Actuator	28.9

\* Note: Indicate desired excess flow closing value when ordering - see chart for values i.e. ME994S-2F-16-260 (260 GPM)  
 To order Kalrez® add "K" for Kalrez® after the prefix part number i.e. ME994SK-2F-16-260  
 To order Neoprene add "N" for Neoprene after the prefix part number i.e. ME994SN-2F-16-260  
 To order Viton® add "V" for Viton® after the prefix part number i.e. ME994SV-2F-16-260  
 Available in Stainless Steel – add "SS" to part number i.e. ME994SS-3F-24-500

MEC Excelsior™ Excelsior-Flange Companion Flange Kits		
Part No. *	Description	Weight (lbs.)
MEP994-2F-16	2" -8 Bolt x 2" FNPT Excelsior-Flange Companion Flange Kit w/ Bolts and O-Ring	3.5
MEP994-2F-2SW	2" -8 Bolt x 2" Socket Weld Excelsior-Flange Companion Flange Kit w/ Bolts and O-Ring	3.6

Available in Stainless Steel with Stainless Steel Bolts – Add "SS" to part number i.e. MEP994SS-3F-3SW



## 2" -300 LB SINGLE AND DOUBLE FLANGED

Intended for use on bobtail delivery trucks, transport trucks and large storage tanks with 2" flanged connections in directional or bi-directional flow applications. Provides both manual shut-down and excess flow closing in the event of the piping being separated from the valve. Can be equipped with manual latch, pneumatic or rotary actuator open/ closing devices. All valve models are equipped with a break-away feature in the cast body which permits the pump or piping to shear off in the event of side impact, leaving the valve poppet intact and protecting the tank from catastrophic product loss.

### FEATURES

- Durable steel body with cadmium surface plating
- All stainless internal component construction
- One piece threaded packing gland
- Precision machined hard coated stem & stem guide
- Fully retained Nitrile seat disc
- Largest variety of excess flow closing values
- Corrosion resistant sleeved flange bolt holes
- Xylan coated corrosion resistant mounting studs
- Roller cam actuation
- Industry's fastest bleed time
- Removable data plate
- Industry's easiest valve to service
- Standard construction utilizes Nitrile seals
- Available with Neoprene, Viton®, or Kalrez® seals
- Available with 316 Stainless Steel bodies
-  LISTED for LPG & NH<sub>3</sub> service
- Rulon™ bearings on stem and stub shafts

**ME990S-2F-16**  
2"-300LB x 2" FNPT



**ME990S-2DFM**  
2"-300LB Double  
Flanged Internal Valve



X	2" Valve Liquid Closing Flow Values
110	110 GPM LPG Closing Flow
160	160 GPM LPG Closing Flow
260	260 GPM LPG Closing Flow
* For NH <sub>3</sub> Multiply GPM by .90	

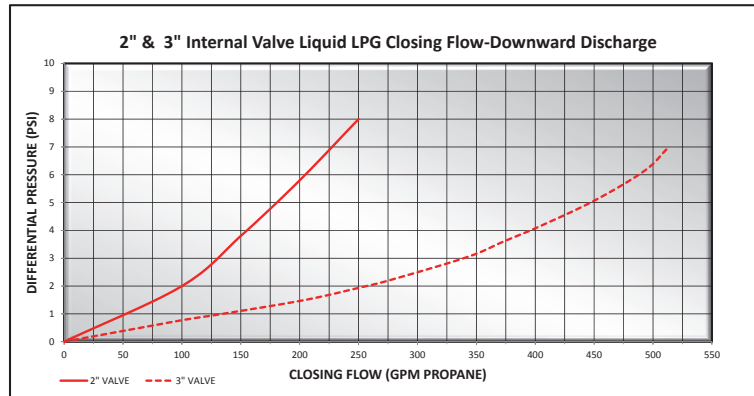

Part No. *	Description
ME990S-2F-16-"X"	Excelerator™ 2"-300 lb. Modified Single Flange x 2" FNPT Internal Valve - Only
ME990SA-2F-16-"X"	Excelerator™ 2"-300 lb. Modified Single Flange x 2" FNPT Internal Valve - with Pneumatic Actuator
ME990SAR-2F-16-"X"	Excelerator™ 2"-300 lb. Modified Single Flange x 2" FNPT Internal Valve - with Rotary Actuator
ME990S-2DFM-"X"	Excelerator™ 2"-300 lb. Modified Double Flange Internal Valve - Only
ME990SA-2DFM-"X"	Excelerator™ 2"-300 lb. Modified Double Flange Internal Valve - with Pneumatic Actuator
ME990SAR-2DFM-"X"	Excelerator™ 2"-300 lb. Modified Double Flange Internal Valve - with Rotary Actuator

\* Note: Indicate desired excess flow closing value when ordering - see chart for values i.e. ME990S-2F-16-260 (260 GPM)  
 To order Kalrez® add "K" for Kalrez® after the prefix part number i.e. ME990SK-2F-16-260  
 To order Neoprene add "N" for Neoprene after the prefix part number i.e. ME990SN-2F-16-260  
 To order Viton® add "V" for Viton® after the prefix part number i.e. ME990SV-2F-16-260

Viton® and Kalrez® are trademarks of DuPont Performance Elastomers.



## 2" & 3"- 300 LB 3-WAY FLANGED TEE BODY SERIES

Intended for use on bobtail delivery trucks, transport trucks and large storage tanks with 2" & 3" flanged connections in directional or bi-directional flow applications. Provides both manual shut-down and excess flow closing in the event of the piping being separated from the valve. Can be equipped with manual latch, pneumatic or rotary actuator open/ closing devices. All valve models are equipped with a break-away feature in the cast body which permits the pump or piping to shear off in the event of side impact, leaving the valve poppet intact and protecting the tank from catastrophic product loss. The flanged tee body features an additional 300 lb. flanged side discharge port for liquid service applications.

### FEATURES

- Durable steel body with cadmium surface plating
- All stainless internal component construction
- One piece threaded packing gland
- Precision machined hard coated stem & stem guide
- Fully retained Nitrile seat disc
- Largest variety of excess flow closing values
- Corrosion resistant sleeved flange bolt holes
- Xylan coated corrosion resistant mounting studs
- Roller cam actuation
- Industry's fastest bleed time
- Removable data plate
- Industry's easiest valve to service
- Standard construction utilizes Nitrile seals
- Available with Neoprene, Viton®, or Kalrez® seals
- Available with 316 Stainless Steel bodies
-  LISTED for LPG & NH<sub>3</sub> service
- Rulon™ bearings on stem and stub shafts



ME993S-16 Series

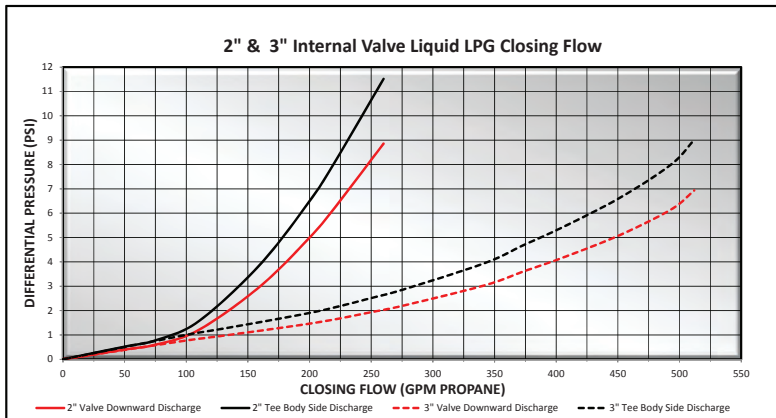

"X"	2" Valve Liquid Closing Flow Values
110	110 GPM LPG Closing Flow
160	160 GPM LPG Closing Flow
260	260 GPM LPG Closing Flow

"X"	3" Valve Liquid Closing Flow Values
175	175 GPM LPG Closing Flow
250	250 GPM LPG Closing Flow
300	300 GPM LPG Closing Flow
375	375 GPM LPG Closing Flow
475	475 GPM LPG Closing Flow
500	500 GPM LPG Closing Flow

\* For NH<sub>3</sub> multiply GPM by .90

MEC Excelsior™ 2" & 3"-300 lb. 3 Way Flanged Tee Body Internal Valves	
Part No. *	Description
ME993S-16-"X"	Excelsior™ 2"-300 lb. Modified Single Flange x (2) 2"-300 lb. Tee Body Internal Valve - Only
ME993SA-16-"X"	Excelsior™ 2"-300 lb. Modified Single Flange x (2) 2"-300 lb. Tee Body Internal Valve - with Pneumatic Actuator
ME993SAR-16-"X"	Excelsior™ 2"-300 lb. Modified Single Flange x (2) 2"-300 lb. Tee Body Internal Valve - with Rotary Actuator
ME993S-24-"X"	Excelsior™ 3"-300 lb. Modified Single Flange x (2) 3"-300 lb. Tee Body Internal Valve - Only
ME993SA-24-"X"	Excelsior™ 3"-300 lb. Modified Single Flange x (2) 3"-300 lb. Tee Body Internal Valve - with Pneumatic Actuator
ME993SAR-24-"X"	Excelsior™ 3"-300 lb. Modified Single Flange x (2) 3"-300 lb. Tee Body Internal Valve - with Rotary Actuator

\* Note: Indicate desired excess flow closing value when ordering - see chart for values i.e. ME993S-24-250 (250 GPM)  
 To order Kalrez® add "K" for Kalrez® after the prefix part number i.e. ME993SK-24-250  
 To order Neoprene add "N" for Neoprene after the prefix part number i.e. ME993SN-24-250  
 To order Viton® add "V" for Viton® after the prefix part number i.e. ME993SV-24-250



## Excelsior-Flange 3"-300 LB X 3" - 8 BOLT UNIVERSAL COMPANION FLANGE SERIES

The ME994S-3F series valves feature our new modular Excelsior-Flange 3"-8 bolt outlet flange design that can be easily adapted to either 3" NPT or socket weld companion flanges (MEP994S-3F-3SW) making it universal to either piping construction.

### FEATURES

- Durable steel body with cadmium surface plating
- Universal 3"-8 bolt outlet flange connection for threaded or welded piping
- Universal 3"-8 bolt outlet flange provides a built-in union joint for easy servicability
- All stainless internal component construction
- One piece threaded packing gland
- Precision machined hard coated stem & stem guide
- Fully retained nitrile seat disc
- Largest variety of excess flow closing values
- Corrosion resistant sleeved flange bolt holes
- Xylan coated corrosion resistant mounting studs
- Roller cam actuation
- Industry's fastest bleed time
- Removable data plate
- Industry's easiest valve to service
- Standard construction utilizes nitrile seals
- Available with Neoprene, Viton®, or Kalrez® seals
- Available with 316 Stainless Steel bodies
- UL LISTED for LPG & NH<sub>3</sub> service
- Rulon™ bearings on stem and stub shafts
- Fits standard 3" - 300# flanged tank openings



ME994S-3F-24



X	3" Valve Liquid Closing Flow Values
175	175 GPM LPG Closing Flow
250	250 GPM LPG Closing Flow
300	300 GPM LPG Closing Flow
375	375 GPM LPG Closing Flow
400	400 GPM LPG Closing Flow
475	475 GPM LPG Closing Flow
500	500 GPM LPG Closing Flow

\* For NH<sub>3</sub> Multiply GPM by .90

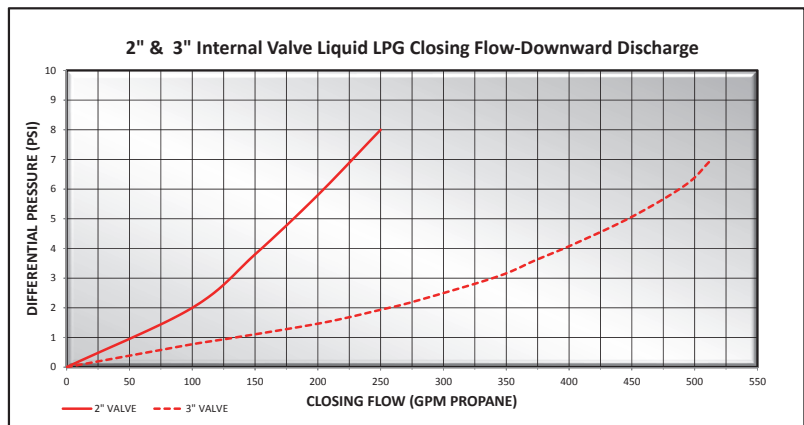

Part No. *	Description	Weight (lbs.)
ME994S-3F-24-"X"	Excelsior™ 3"-300 lb. Modified Single Flange x 3"-8 Bolt Companion Flange Internal Valve - Only	38.3
ME994SA-3F-24-"X"	Excelsior™ 3"-300 lb. Modified Single Flange x 3"-8 Bolt Companion Flange Internal Valve - w/ Pneumatic Actuator	52.8
ME994SAR-3F-24-"X"	Excelsior™ 3"-300 lb. Modified Single Flange x 3"-8 Bolt Companion Flange Internal Valve - w/ Rotary Actuator	45.9

\* Note: Indicate desired excess flow closing value when ordering - see chart for values i.e. ME994S-3F-24-260 (260 GPM)  
 To order Kalrez® add "K" for Kalrez® after the prefix part number i.e. ME994SK-3F-24-260  
 To order Neoprene add "N" for Neoprene after the prefix part number i.e. ME994SN-3F-24-260  
 To order Viton® add "V" for Viton® after the prefix part number i.e. ME994SV-3F-24-260  
 To order Stainless Steel add "SS" to part number i.e. ME994SS-3F-24-500

MEC Excelsior™ Excelsior-Flange Companion Flange Kits		
Part No. *	Description	Weight (lbs.)
MEP994-3F-24	3" -8 Bolt x 3" FNPT Excelsior-Flange Companion Flange Kit w/ Bolts and O-Ring	4.8
MEP994-3F-3SW	3" -8 Bolt x 3" Socket Weld Excelsior-Flange Companion Flange Kit w/ Bolts and O-Ring	4.9

Available in Stainless Steel with Stainless Steel Bolts – Add "SS" to part number i.e. MEP994SS-3F-3SW

Viton® and Kalrez® are trademarks of DuPont Performance Elastomers.



## 2" & 3"- FLANGED TEE BODIES

Intended for use on bobtail delivery trucks, transport trucks and large storage tanks with 2" & 3" flanged connections in directional or bi-directional flow applications. Provides both manual shut-down and excess flow closing in the event of the piping being separated from the valve. Can be equipped with manual latch, pneumatic or rotary actuator or open/ closing devices. All valve models are equipped with a break-away feature in the cast body which permits the pump or piping to shear off in the event of side impact, leaving the valve poppet intact and protecting the tank from catastrophic product loss. The tee body features an additional FNPT side discharge port for liquid service applications.



### FEATURES

- Durable steel body with cadmium surface plating
- All stainless internal component construction
- One piece threaded packing gland
- Precision machined hard coated stem & stem guide
- Fully retained Nitrile seat disc
- Largest variety of excess flow closing values
- Corrosion resistant sleeved flange bolt holes
- Xylan coated corrosion resistant mounting studs
- Roller cam actuation
- Industry's fastest bleed time
- Removable data plate
- Industry's easiest valve to service
- Standard construction utilizes Nitrile seals
- Available with Neoprene, Viton®, or Kalrez® seals
- Available with 316 Stainless Steel bodies
- LISTED for LPG & NH<sub>3</sub> service
- Rulon™ bearings on stem and stub shafts

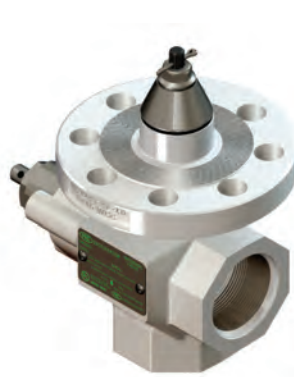

ME992S-2F-16



ME992S-3F-24

"X"	2" Valve Liquid Closing Flow Values
110	110 GPM LPG Closing Flow
160	160 GPM LPG Closing Flow
260	260 GPM LPG Closing Flow

"X"	3" Valve Liquid Closing Flow Values
175	175 GPM LPG Closing Flow
250	250 GPM LPG Closing Flow
300	300 GPM LPG Closing Flow
375	375 GPM LPG Closing Flow
475	475 GPM LPG Closing Flow
500	500 GPM LPG Closing Flow

\* For NH<sub>3</sub> multiply GPM by .90

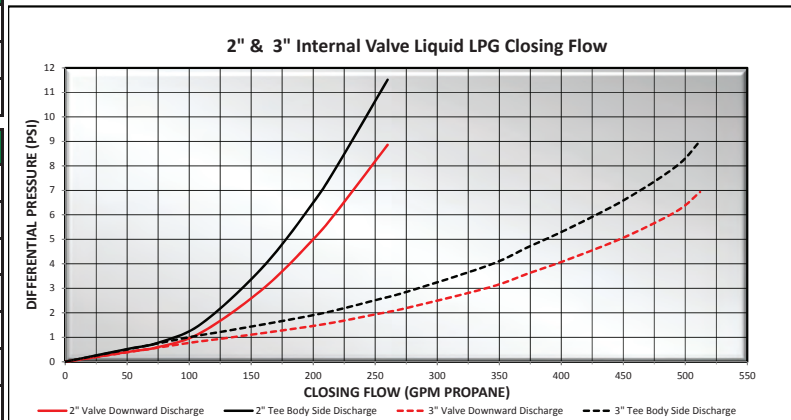

MEC Excelsior™ 2" & 3" Flanged Tee Body Internal Valves	
Part No. *	Description
ME992S-2F-16-"X"	Excelsior™ 2"-300 lb. Modified Single Flange x 2" FNPT Tee Body Internal Valve - Only
ME992SA-2F-16-"X"	Excelsior™ 2"-300 lb. Modified Single Flange x 2" FNPT Tee Body Internal Valve - with Pneumatic Actuator
ME992SAR-2F-16-"X"	Excelsior™ 2"-300 lb. Modified Single Flange x 2" FNPT Tee Body Internal Valve - with Rotary Actuator
ME992S-3F-24-"X"	Excelsior™ 3"-300 lb. Modified Single Flange x 3" FNPT Tee Body Internal Valve - Only
ME992SA-3F-24-"X"	Excelsior™ 3"-300 lb. Modified Single Flange x 3" FNPT Tee Body Internal Valve - with Pneumatic Actuator
ME992SAR-3F-24-"X"	Excelsior™ 3"-300 lb. Modified Single Flange x 3" FNPT Tee Body Internal Valve - with Rotary Actuator

\* Note: Indicate desired excess flow closing value when ordering - see chart for values i.e. ME992S-3F-24-250 (250 GPM)  
 To order Kalrez® add "K" for Kalrez® after the prefix part number i.e. ME992SK-3F-24-250  
 To order Neoprene add "N" for Neoprene after the prefix part number i.e. ME992SN-3F-24-250  
 To order Viton® add "V" for Viton® after the prefix part number i.e. ME992SV-3F-24-250



## 3" - FLANGED INTERNAL VALVES

Intended for use on bobtail delivery trucks, transport trucks and large storage tanks with 3" flanged connections in directional or bi-directional flow applications. Provides both manual shut-down and excess flow closing in the event of the piping being separated from the valve. Can be equipped with manual latch, pneumatic or rotary actuator or open/ closing devices. All valve models are equipped with a break-away feature in the cast body which permits the pump or piping to shear off in the event of side impact, leaving the valve poppet intact and protecting the tank from catastrophic product loss.

### FEATURES

- Durable steel body with cadmium surface plating
- All stainless internal component construction
- One piece threaded packing gland
- Precision machined hard coated stem & stem guide
- Fully retained Nitrile seat disc
- Largest variety of excess flow closing values
- Corrosion resistant sleeved flange bolt holes
- Xylan coated corrosion resistant mounting studs
- Roller cam actuation
- Industry's fastest bleed time
- Removable data plate
- Industry's easiest valve to service
- Standard construction utilizes Nitrile seals
- Available with Neoprene, Viton®, or Kalrez® seals
- Available with 316 Stainless Steel bodies
-  LISTED for LPG & NH<sub>3</sub> service
- Rulon™ bearings on stem and stub shafts



**ME990S-3F-24**  
Modified Single  
Flange Series



**ME990S-3DF**  
Standard Double Flange Series



**ME990S-3DFM**  
Modified Double  
Flange Series

"X"	3" Valve Liquid Closing Flow Values
175	175 GPM LPG Closing Flow
250	250 GPM LPG Closing Flow
300	300 GPM LPG Closing Flow
375	375 GPM LPG Closing Flow
400	400 GPM LPG Closing Flow
475	475 GPM LPG Closing Flow
500	500 GPM LPG Closing Flow

For NH<sub>3</sub> Multiply GPM by .90

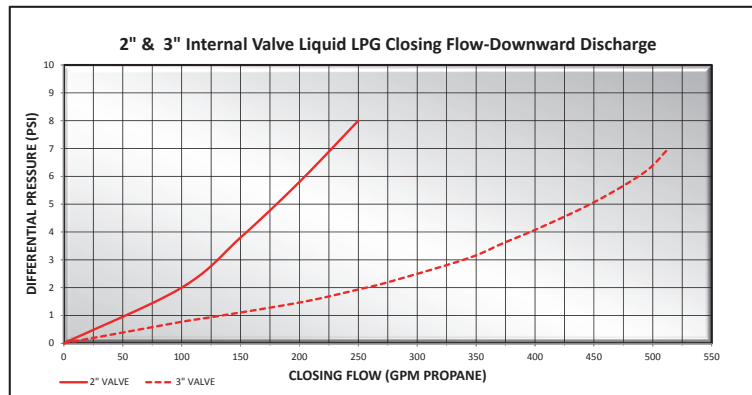

MEC Excelerator™ 3" Flanged Internal Valves	
Part No. *	Description
ME990S-3DF-"X"	Excelerator™ 3" Double Flange Bobtail Internal Valve - Only
ME990SA-3DF-"X"	Excelerator™ 3" Double Flange Bobtail Internal Valve - with Pneumatic Actuator
ME990SAR-3DF-"X"	Excelerator™ 3" Double Flange Bobtail Internal Valve - with Rotary Actuator
ME990S-3DFM-"X"	Excelerator™ 3"-300 lb. Modified Double Flange Internal Valve - Only
ME990SA-3DFM-"X"	Excelerator™ 3"-300 lb. Modified Double Flange Internal Valve - with Pneumatic Actuator
ME990SAR-3DFM-"X"	Excelerator™ 3"-300 lb. Modified Double Flange Internal Valve - with Rotary Actuator
ME990S-3F-24-"X"	Excelerator™ 3"-300 lb. Modified Single Flange x 3" FNPT Internal Valve - Only
ME990SA-3F-24-"X"	Excelerator™ 3"-300 lb. Modified Single Flange x 3" FNPT Internal Valve - with Pneumatic Actuator
ME990SAR-3F-24-"X"	Excelerator™ 3"-300 lb. Modified Single Flange x 3" FNPT Internal Valve - with Rotary Actuator

\* Note: Indicate desired excess flow closing value when ordering - see chart for values i.e. ME990S-3SF-250 (250 GPM)  
 To order Kalrez® add "K" for Kalrez® after the prefix part number i.e. ME990SK-SDF-300  
 To order Neoprene add "N" for Neoprene after the prefix part number i.e. ME990SN-SDF-300  
 To order Viton® add "V" for Viton® after the prefix part number i.e. ME990SV-SDF-300

Viton® and Kalrez® are trademarks of DuPont Performance Elastomers.



## NEXT GENERATION

### 3" -300 LB DOUBLE FLANGED OFF-SET INTERNAL VALVES

Intended for use on bobtail delivery trucks with 3" flanged connections in directional or bi-directional flow applications. The 3" offset outlet flange prevents pump installation interference with truck frame rails, cross members, PTO covers, drive shafts, and other common obstacles when remounting bobtail vessels onto new chassis. In order to reduce the amount of offset from the 2" maximum to 1-1/4", simply rotate the inlet flange connection by 1 bolt hole either direction. To eliminate the offset entirely, simply rotate 1 more bolt hole. The Excelerator™ offset is equipped with three separate packing gland locations to prevent interference while mounting the valve actuator no matter how you choose to mount the valve. Provides both manual shut-down and excess flow closing in the event the of the valve being separated from the tank. Can be equipped with pneumatic or rotary actuator open/closing devices. All valve models are equipped with a break-away feature in the cast body which permits the pump or piping to shear off in the event of side impact, leaving the valve poppet intact and protecting the tank from catastrophic product loss.

#### FEATURES

- Rotate valve body in either direction 1 bolt hole to reduce offset to 1-1/4"
- Standard with 3 gland ports for stem relocation (2 plugged)
- Each gland port can accept pneumatic or rotary type actuators
- Durable steel body with cadmium surface plating
- All stainless internal component construction
- One piece threaded packing gland
- Precision machined hard coated stem & stem guide
- Fully retained nitrile seat disc
- Largest variety of excess flow closing values
- Corrosion resistant sleeved flange bolt holes
- Xylan coated corrosion resistant mounting studs
- Roller cam actuation
- Industry's fastest bleed time
- Removable data plate
- Industry's easiest valve to service
- Standard construction utilizes nitrile seals
- Available with Neoprene, Viton®, or Kalrez® seals
- Available with 316 Stainless Steel bodies
-  LISTED for LPG & NH<sub>3</sub> service
- Rulon™ bearings on stem and stub shafts

ME990S-3DFO 

Alternate Gland Ports (Plugged)

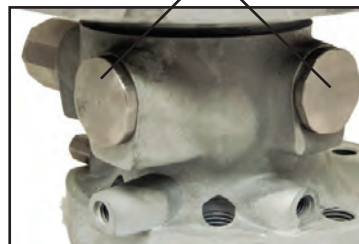

"X"	3" Valve Liquid Closing Flow Values
175	175 GPM LPG Closing Flow
250	250 GPM LPG Closing Flow
300	300 GPM LPG Closing Flow
375	375 GPM LPG Closing Flow
400	400 GPM LPG Closing Flow
475	475 GPM LPG Closing Flow
500	500 GPM LPG Closing Flow

For NH<sub>3</sub> Multiply GPM by .90

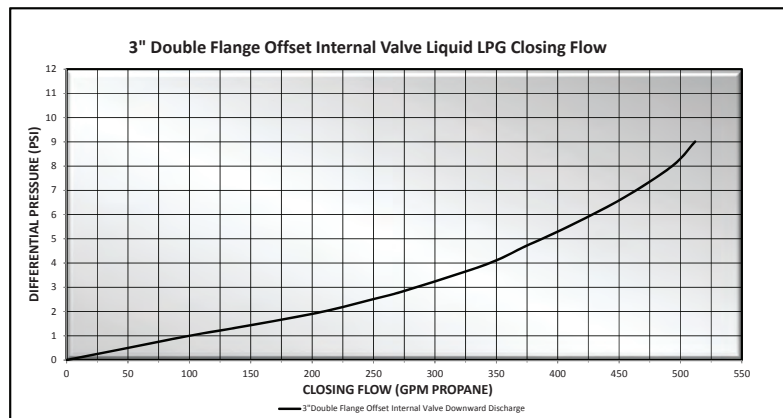

Part No. *	Description
ME990S-3DFO-"X"	Excelerator™ 3" Double Flange Offset Bobtail Internal Valve - Only
ME990SA-3DFO-"X"	Excelerator™ 3" Double Flange Offset Bobtail Internal Valve - with Pneumatic Actuator
ME990SAR-3DFO-"X"	Excelerator™ 3" Double Flange Offset Bobtail Internal Valve - with Rotary Actuator

\*Note: Indicate desired excess flow closing value when ordering - see chart for values i.e. ME990S-3DFO-250 (250 GPM)  
 Available in all Stainless Steel Construction  
 To order Kalrez® add "K" for Kalrez® after the prefix part number i.e. ME990SK-3DFO-300  
 To order Neoprene add "N" for Neoprene after the prefix part number i.e. ME990SN-3DFO-300  
 To order Viton® add "V" for Viton® after the prefix part number i.e. ME990SV-3DFO-300

Viton® and Kalrez® are trademarks of DuPont Performance Elastomers.



## 4"-300 LB FLANGED

Intended for use on transport trucks and large storage tanks with 4" flanged connections in directional or bi-directional flow applications. Provides both manual shut-down as well as excess flow closing in the event of the piping being separated from the valve. Can be equipped with manual latch, pneumatic or rotary actuator open/ closing devices.

### FEATURES

- All stainless construction
- Precision machined stem & stem guide
- Fully retained disc
- Largest variety of excess flow closing values
- Available with standard or #5 mesh filter screen
- Corrosion resistant sleeved flange bolt holes
- Xylan coated corrosion resistant mounting studs
- Removable data plate
- Threaded packing gland with seal ejector spring
- Standard construction utilizes Nitrile seals
- Available with Neoprene, Viton®, or Kalrez® seals
-  LISTED for LPG & NH<sub>3</sub> service
- Rulon™ bearings on stem and stub shafts

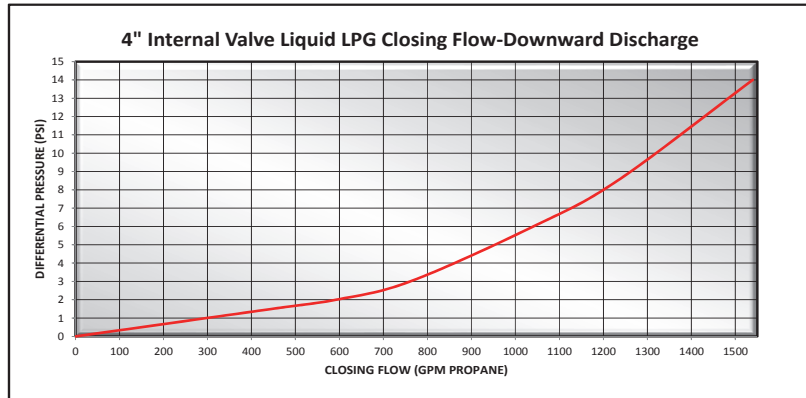

"X"	4" Valve Liquid Closing Flow Values
375	375 GPM LPG Closing Flow
500	500 GPM LPG Closing Flow
650	650 GPM LPG Closing Flow
850	850 GPM LPG Closing Flow
1250	1,250 GPM LPG Closing Flow
1500	1,500 GPM LPG Closing Flow

\* For NH<sub>3</sub> Multiply GPM by .90

Part No. *	Description
ME990-4F-"X"	Excelerator™ 4" Single Flange Internal Valve - Only
ME990A-4F-"X"	Excelerator™ 4" Single Flange Internal Valve - with Pneumatic Actuator
ME990AR-4F-"X"	Excelerator™ 4" Single Flange Internal Valve - with Rotary Actuator
ME990M-4F-"X"	Excelerator™ 4" Single Flange Internal Valve - with Manual Latch

\* Note: Indicate desired excess flow closing value when ordering - see chart for values  
 i.e. ME990-4F-650 (650 GPM)  
 For #5 Mesh screen add /5 e.i. ME990-4F-650/5  
 To order Kalrez® add "K" for Kalrez® after the prefix part number i.e. ME990AK-4F-500  
 To order Neoprene add "N" for Neoprene after the prefix part number i.e. ME990AN-4F-500  
 To order Viton® add "V" for Viton® after the prefix part number i.e. ME990AV-4F-500

Viton® and Kalrez® are trademarks of DuPont Performance Elastomers.



## 4"-300 LB. & 6" -300 LB DOUBLE FLANGED INTERNAL VALVES

Intended for use on transport trucks and large storage tanks with 4" or 6" flanged connections in directional or bi-directional flow applications. Provides both manual shut-down and excess flow closing in the event of the piping being seperated from the valve. Equipped standard with a rotary actuator open/closing devices. All valve models are equipped with a break-away feature in the cast body which permits the pump or piping to shear off in the event of side impact, leaving the valve poppet intact and protecting the tank from catastrophic product loss.

### FEATURES

- Durable steel body with cadmium surface plating
- All stainless internal component construction
- One piece threaded packing gland
- Precision machined hard coated stem & stem guide
- Fully retained nitrile seat disc
- Largest variety of excess flow closing values
- Corrosion resistant sleeved flange bolt holes
- Xylan coated corrosion resistant mounting studs
- Roller cam actuation
- Industry's fastest bleed time
- Removable data plate
- Industry's easiest valve to service
- Standard construction utilizes nitrile seals
- Available with Viton® or Kalrez® seals
- Available with 316 Stainless Steel bodies
-  LISTED for LPG & NH<sub>3</sub> service
- Rulon™ bearings on stem and stub shafts
- Fits standard 300# flange openings



**ME990SAR-4DFM**

4"-300LB Modified Double Flange Series

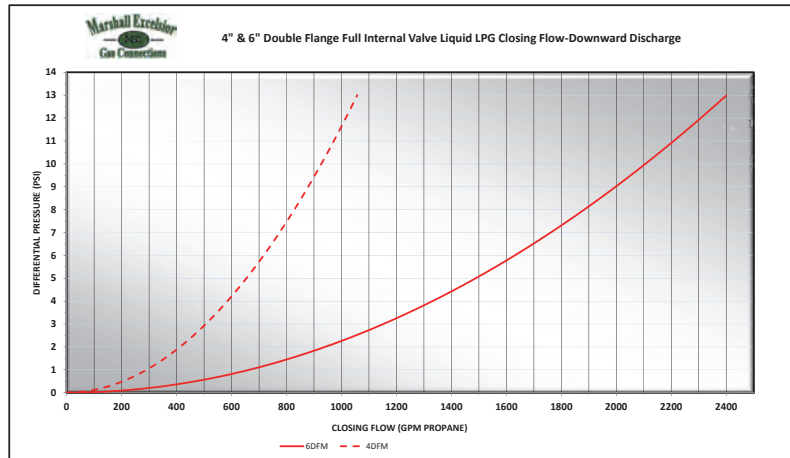

"X"	4" Valve Liquid Closing Flow Values
375	375 GPM LPG Closing Flow
500	500 GPM LPG Closing Flow
650	650 GPM LPG Closing Flow
800	800 GPM LPG Closing Flow
900	900 GPM LPG Closing Flow
1000	1000 GPM LPG Closing Flow

\* For NH<sub>3</sub> Multiply GPM by .90

"X"	6" Valve Liquid Closing Flow Values
650	650 GPM LPG Closing Flow
1000	1000 GPM LPG Closing Flow
1250	1250 GPM LPG Closing Flow
1500	1500 GPM LPG Closing Flow
1800	1800 GPM LPG Closing Flow
2400	2400 GPM LPG Closing Flow

\* For NH<sub>3</sub> Multiply GPM by .90

MEC Excelsior™ 4" & 6" Flanged Internal Valves	
Part No. *	Description
ME990SAR-4DFM-"X"	Excelsior™ 4"-300 lb. Modified Double Flange Internal Valve - with Rotary Actuator
ME990SAR-6DFM-"X"	Excelsior™ 6"-300 lb. Modified Double Flange Internal Valve - with Rotary Actuator

\* Note: Indicate desired excess flow closing value when ordering - see chart for values i.e. ME990SAR-4DFM-375 (375 GPM)  
 Available in all Stainless Steel Construction  
 To order Kalrez® add "K" for Kalrez® after the prefix part number i.e. ME990SKAR-4DFM--375  
 To order Viton® add "V" for Viton® after the prefix part number i.e. ME990SVAR-4DFM-375

Viton® and Kalrez® are trademarks of DuPont Performance Elastomers.



## TANK FLANGE CONNECTIONS

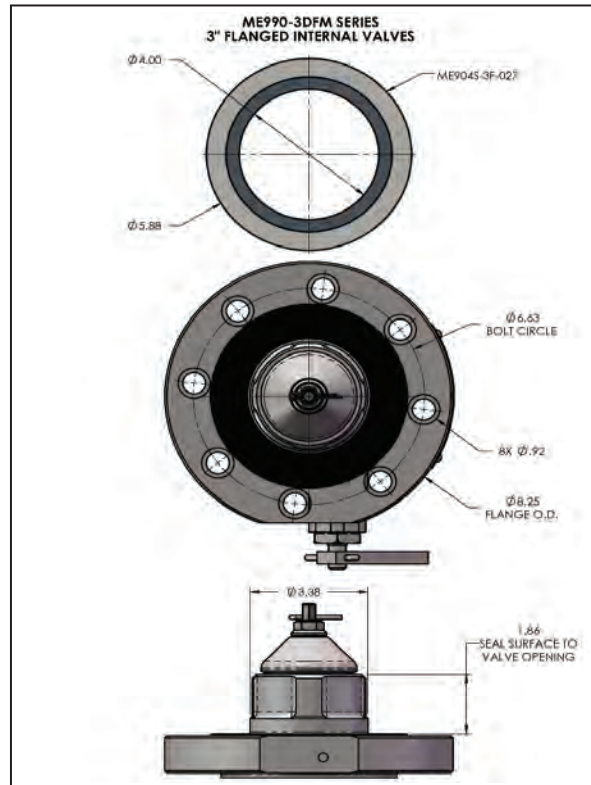
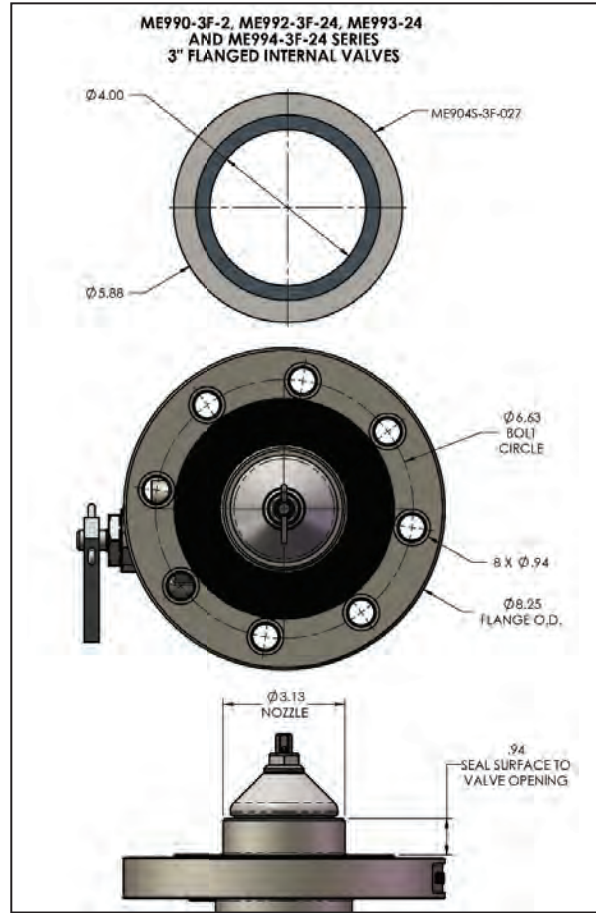
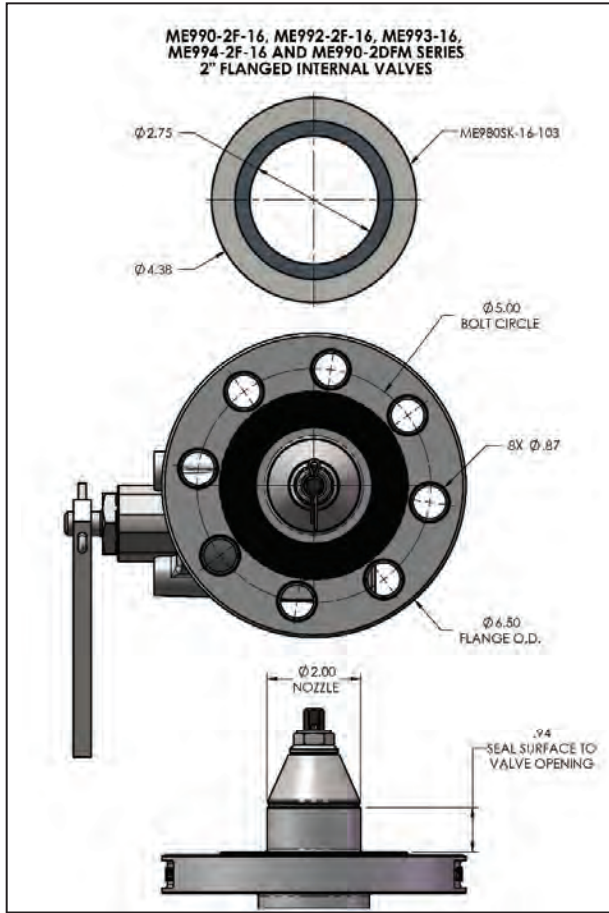

## TANK FLANGE CONNECTIONS

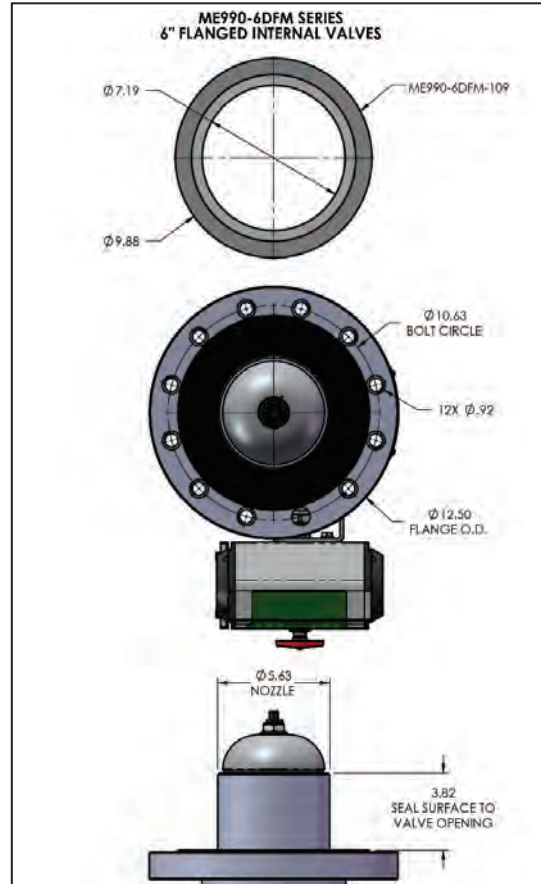
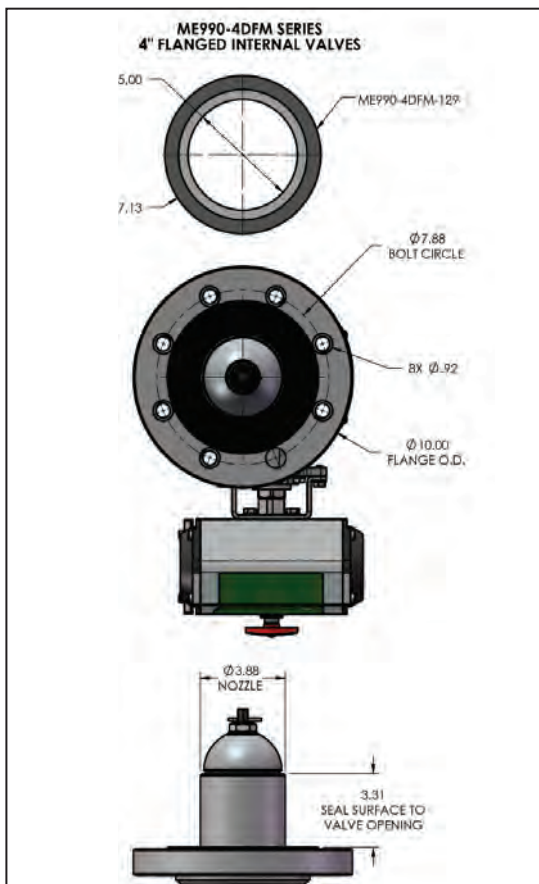
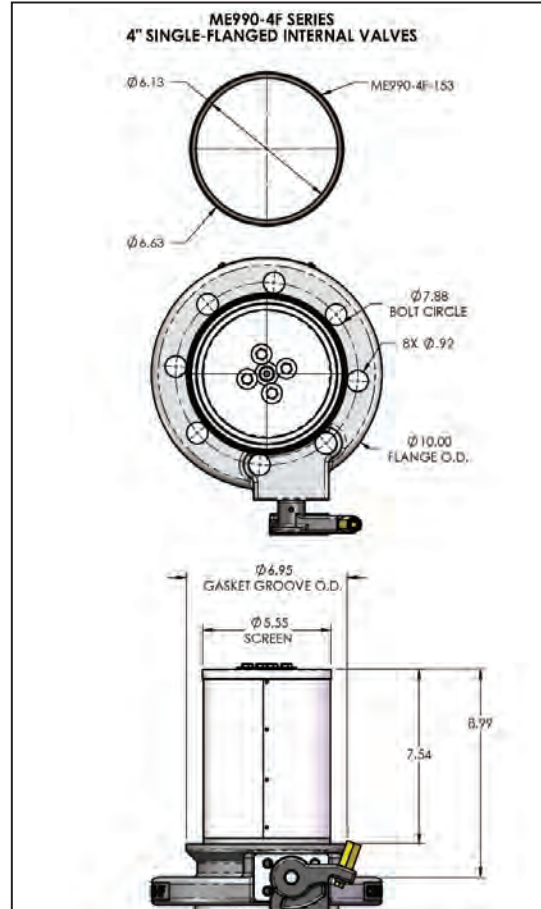
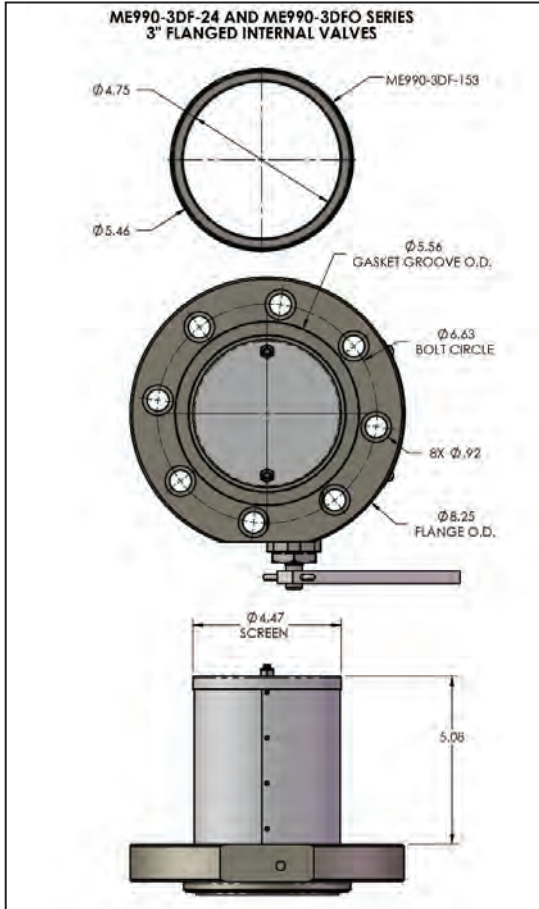

# INTERNAL VALVE ACTUATORS

## PowerTorq SERIES

These direct drive actuators are designed to maximize the life of the internal valve by eliminating side pressure on the valve's packing stem. These actuators are intended to be used at remote locations or operated directly off the air brake system in bobtail or transport applications.

The low temperature factory installed seals allow these actuators to be used with air, nitrogen, carbon dioxide or LP-Gas vapor. In case of a fire the factory provided thermal plug melts at 212° Fahrenheit releasing pressure allowing the internal valve to close. The factory set rotation of these actuators require no modification, can be oriented in any direction and all hardware needed for installation is provided.

### FEATURES

- Stainless steel all weather mounting hardware
  - Field repairable under full tank pressure
  - Anodized aluminum actuator body with easy to see open/close indicator
  - No pinch points for operator safety
  - Includes mounting bracket for ME707 Quick Release Valve
- Note: ME707 is not required for operation



#### Actuator Operating Pressure Limits:

Minimum = 25 PSIG  
 Maximum = 125 PSIG  
 Recommended = 40-60 PSIG

### PowerTorq Actuators



Part No.	Actuator Type	Fits MEC*	Fits Fisher*	Internal Valve
ME225	Direct Drive	ME990-10, ME991-10, ME992-10	Fisher® C407	1-1/4" Threaded
ME226	Direct Drive	ME990-16, ME990-24, ME990S-3F-24, ME990S-2DFM, ME991-16, ME991-24, ME992-16, ME992-24, ME993S-16, ME993S-24	Fisher® C402, C421, C427, C471, C477	2" & 3" Threaded
ME227	Direct Drive	ME990S-3DF & ME990S-3DFM	Fisher® C403-24 & C483-24 Series	3" Double Flange
ME228	Direct Drive	ME990-4F	Fisher® C404-32 & C484-32 Series	4" Single Flange

\* Also fits Cavagna 6902900 Series internal valves

Fisher® and Fisher® Internal Valves are the trademarks of Emerson Process Management; Cavagna is the trademark of Cavagna Group

## ACTUATOR ACCESSORIES

**ME707**—The quick release valve is used in conjunction with Marshall Excelsior's air actuators to decrease the response time when closing actuators. They are particularly effective when long distances (75 feet or more) exist between the actuator and the actuator control valve.

**ME708**—The 0-150 psig air pressure regulator prolongs the life of the air actuator and air system by allowing the air pressure to be set and regulated at the minimum required operating pressure for each individual system.

**ME709**—The gas/air filter is used to filter foreign materials and/or particles from LP-Gas systems such as motor fuel/carburetion systems. Also designed to be used to filter air supply lines for internal and emergency shutoff valve actuator systems.



Universal Mounting Bracket Included



Part No.	Inlet	Outlet
ME707	3/8" FNPT	3/8" FNPT (2 Ports)
ME708	1/4" FNPT	1/4" FNPT
ME709	1/4" FNPT	1/4" MNPT
MEGR-130-50	1/4" FNPT	1/4" FNPT



# INTERNAL VALVE ACTUATORS

## POWERSTROKE AND FASTROKE SERIES

Designed with a heavy duty stainless steel frame to withstand the toughest conditions. These actuators are intended to be used at remote locations or operated directly off the air brake system in bobtail or transport applications.

The actuator's smooth acting cam opens the internal valve lever when air, nitrogen, or carbon dioxide is applied to the line. When pressure to the line is released, the internal valve automatically closes. In case of a fire the factory provided thermal plug melts at 212° Fahrenheit releasing pressure allowing the internal valve to close. These actuators require no modification and all hardware needed for installation is provided.

Part No.	Actuator Type	Fits MEC*	Fits*	Internal Valve
ME205	Airstroke™ by Firestone	ME990-10, ME991-10, ME992-10	Fisher® C407	1-1/4" Threaded
ME205R	Airstroke™ by Firestone	—	RegO® A3209R	1-1/4" Threaded
ME206	#9 Chamber	ME990-16, ME990-24, ME990S-3F-24, ME990S-2DFM, ME991-16, ME991-24, ME992-16, ME993S-16, ME993S-24	Fisher® C402, C421, C471, C427, C477	2" & 3" Threaded
ME207	#9 Chamber	ME990S-3DF & ME990S-3DFM	Fisher® C403-24 & C483-24 Series	3" Double Flange
ME207SF	#9 Chamber	—	Fisher® C404-24 Series	3" Single Flange
ME208SF	#24 Chamber	ME990-4F	Fisher® C404-32 & C484-32 Series	4" Single Flange
ME710	Airstroke™ by Firestone	—	RegO® Flowmatic® Three-Way Valve	

\* Also fits Cavagna 6902900 Series internal valves



### FaStroke Actuators



ME710

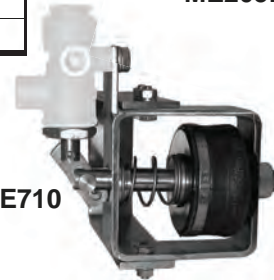

#### ACTUATOR OPERATING PRESSURE LIMITS:

Minimum = 20 PSIG  
 Maximum = 125 PSIG  
 Recommended = 20-25 PSIG

## PowerStroke Actuators

ME206



ME208SF



ME207



\*Internal valves not included

Airstroke™ is a trademark of Firestone Industrial Products Company, Fisher® and Fisher® Internal Valves are the trademarks of Emerson Process Management; RegO® and Flomatic® Internal Valves are the trademarks of Engineered Controls International, Inc. and Cavagna is the trademark of Cavagna Group



# INTERNAL VALVE ACCESSORIES



Latches	
Part No.	Description
ME990-10-902	Excelerator™ Manual Latch Assembly for 1-1/4" Threaded Internal Valves
MEP990-24	Excelerator™ Manual Latch Assy For ME990-16, ME990-24, ME991-16 and ME991-24 Internal Valves
MEP990-4F	Excelerator™ Manual Latch Assy For ME990-4F Series

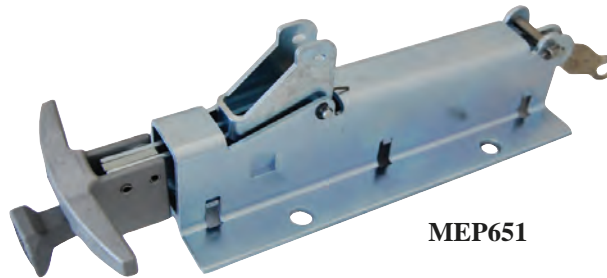

Releases	
Part No.	Description
MEP650	Excelerator™ Open/Close Cable Control Release with 50' Cable
MEP651	Excelerator™ Open/Close Cable Control Release - Only

# ESV/INTERNAL VALVE ACCESSORIES



Part No.	Description
ME980-905	Universal ESV/Internal Valve Remote Release / No Cable
ME980-905-25	Universal ESV/Internal Valve Remote Release W/ 25' Cable
ME980-905-50	Universal ESV/Internal Valve Remote Release W/ 50' Cable
ME980-906-25	Remote Release Cable Assy. 5/16-24UNF - 25' OAL
ME980-906-50	Remote Release Cable Assy. 5/16-24UNF - 50' OAL



# EMERGENCY SHUTOFF VALVE ACTUATORS

Designed to be used with emergency shutoff valves in remote locations. Pressure to the line enables a smooth acting cam to completely open the emergency shutoff valve for full flow operation. When pressure to the line is released, the emergency shutoff valve automatically closes. In case of a fire a thermal plug melts at 212° Fahrenheit releasing pressure allowing the ESV to close. These actuators require no modification and all hardware needed for installation is provided.

The PowerTorq direct drive actuator maximizes the life of the emergency shutoff valve by eliminating side pressure on the valve's packing stem.

## PowerTorq

### FEATURES

- Stainless steel all weather mounting hardware
- Field repairable under full tank pressure
- Low temperature factory installed seals allow use with air, nitrogen, carbon dioxide or LP-Gas vapor
- Anodized aluminum actuator body with easy to see open/close indicator
- No pinch points for operator safety
- Factory installed thermal plug
- Includes mounting bracket for ME707 Quick Release Valve. Note: ME707 is not required for operation



**Actuator Operating Pressure Limits:**  
 Minimum = 25 PSIG  
 Maximum = 125 PSIG  
 Recommended = 40-60 PSIG

## SAFETY STROKE

### FEATURES

- Heavy duty stainless steel all weather bracket
- Use with air, nitrogen or carbon dioxide
- Uses existing Fisher® thermal plug



ME980 Series  
 Emergency Shutoff Valves  
 not included

**Actuator Operating Pressure Limits:**  
 Minimum = 20 PSIG  
 Maximum = 125 PSIG  
 Recommended = 20-25 PSIG

Part No.	Actuator Type	Fits MEC	Fits	ESV
ME551	Airstroke™ by Firestone	ME980-10, ME980-16, ME980-16-2F, ME980-24, ME980-24-3F, ME980-24-4F	Fisher® N550 Series	1-1/4", 2" & 3"
ME552	Direct Drive	ME980-10, ME980-16, ME980-16-2F, ME980-24, ME980-24-3F, ME980-24-4F	Fisher® N550 Series	1-1/4", 2" & 3"

Airstroke™ is a trademark of Firestone Industrial Products Company, Fisher® and Fisher® Internal Valves are the trademarks of Emerson Process Management



# EMERGENCY SHUTOFF VALVES

Emergency Shutoff Valves (ESV's) are designed to provide rapid and positive shutdown of gas lines should a down stream rupture or piping break occur. Due to the presence of a built-in fusible element at the valve operating hub the ESV will automatically close when exposed to heat between 212° F. - 250° F. These valves are ideally suited for installation at bulkheads or inline plumbing for automatic emergency shutdown as a result of fire or to provide immediate and positive manual or remote shutdown.

## FEATURES

- Powder coated ductile iron body for maximum durability
- Integral swing away check valve with soft seat to promote maximum product flow and minimize product loss in the event of a line failure
- All stainless steel internal component construction provides maximum corrosion resistance
- Flanged end connection for ease of field service
-  LISTED for use with LP Gas and Anhydrous Ammonia - 400 PSI WOG
- Integral fusible element for automatic closure when exposed to fire
- Durable Teflon® packing gland and resilient seals provide long lasting service life
- Available with pneumatic or cable style latch mechanism

ME980C-6



ME980-10



ME980-24



ME980-16

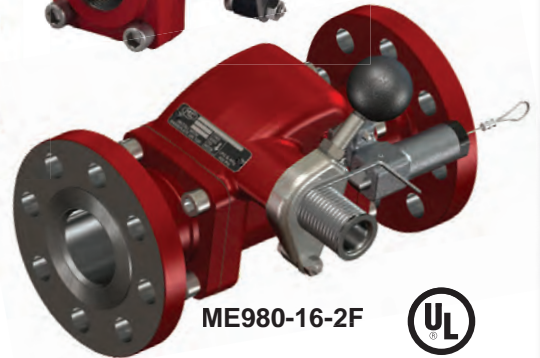

ME980-16-2F



Part No.	Description	Latch Type	Material	Flange Material	OAL
ME980-6	3/4" FNPT Emergency Shutoff Valve (ESV)	Pneumatic	Ductile Iron	Ductile Iron	4-3/4"
ME980-8	1" FNPT Emergency Shutoff Valve (ESV)	Pneumatic	Ductile Iron	Ductile Iron	4-3/4"
ME980C-6	3/4" FNPT Emergency Shutoff Valve (ESV)	Cable	Ductile Iron	Ductile Iron	4-3/4"
ME980C-8	1" FNPT Emergency Shutoff Valve (ESV)	Cable	Ductile Iron	Ductile Iron	4-3/4"
ME980-10	1-1/4" FNPT Emergency Shutoff Valve (ESV)	Pneumatic	Ductile Iron	Ductile Iron	5-3/8"
ME980C-10	1-1/4" FNPT Emergency Shutoff Valve (ESV)	Cable	Ductile Iron	Ductile Iron	5-3/8"
ME980-12	1-1/2" FNPT Emergency Shutoff Valve (ESV)	Pneumatic	Ductile Iron	Ductile Iron	5-3/8"
ME980C-12	1-1/2" FNPT Emergency Shutoff Valve (ESV)	Cable	Ductile Iron	Ductile Iron	5-3/8"
ME980-16	2" FNPT Emergency Shutoff Valve (ESV)	Pneumatic	Ductile Iron	Cast Steel	6-7/8"
ME980C-16	2" FNPT Emergency Shutoff Valve (ESV)	Cable	Ductile Iron	Cast Steel	6-7/8"
ME980-24	3" FNPT Emergency Shutoff Valve (ESV)	Pneumatic	Ductile Iron	Ductile Iron	9-5/8"
ME980C-24	3" FNPT Emergency Shutoff Valve (ESV)	Cable	Ductile Iron	Ductile Iron	9-5/8"
ME980-16-2F	2" - 300 lb. Flange Emergency Shutoff Valve (ESV)	Pneumatic	Ductile Iron	Ductile Iron	11-7/8"
ME980C-16-2F	2" - 300 lb. Flange Emergency Shutoff Valve (ESV)	Cable	Ductile Iron	Ductile Iron	11-7/8"
ME980-24-3F	3" - 300 lb. Flange Emergency Shutoff Valve (ESV)	Pneumatic	Ductile Iron	Ductile Iron	14-1/8"
ME980C-24-3F	3" - 300 lb. Flange Emergency Shutoff Valve (ESV)	Cable	Ductile Iron	Ductile Iron	14-1/8"
ME980-24-4F	4" - 300 lb. Flange Emergency Shutoff Valve (ESV)	Pneumatic	Ductile Iron	Ductile Iron	14-1/4"
ME980C-24-4F	4" - 300 lb. Flange Emergency Shutoff Valve (ESV)	Cable	Ductile Iron	Ductile Iron	14-1/4"

To order ESV with Pneumatic Actuator add "A" after the prefix part number i.e. ME980A-10  
 To order ESV with Rotary Actuator add "AR" after the prefix part number i.e. ME980AR-10



# EMERGENCY SHUTOFF VALVES

## High Capacity FLANGED

Emergency Shutoff Valves (ESV's) are designed to provide rapid and positive shutdown of gas lines should a downstream rupture or piping break occur. Due to the presence of a built-in fusible element at the valve operating hub the ESV will automatically close when exposed to heat between 212° F. - 250° F. These valves are ideally suited for installation at bulkheads or inline plumbing for automatic emergency shutdown as a result of fire or to provide immediate and positive manual or remote shutdown.

### FEATURES

- Cadmium plated steel / ductile iron body for maximum durability
- Long stroke internal valve poppet for maximum product flow
- All stainless steel internal component construction provides maximum corrosion resistance
- Flanged end connection for ease of field service
-  Listed for use with LP Gas and Anhydrous Ammonia - 400 PSI WOG
- Integral fusible element for automatic closure when exposed to fire
- Durable Teflon® packing gland and resilient seals provide long lasting service life
- Pre-mounted inlet bell housing for quick and easy installation
- All mounting hardware included



ME980SAR-4DFM



Emergency Shut Off Valves (ESV's)		
Part No.	Description	Actuator Type
ME980SAR-4DFM	4" - 300LB Flange Emergency Shutoff Valve (ESV)	Rotary
ME980SAR-6DFM	6" - 300LB Flange Emergency Shutoff Valve (ESV)	Rotary

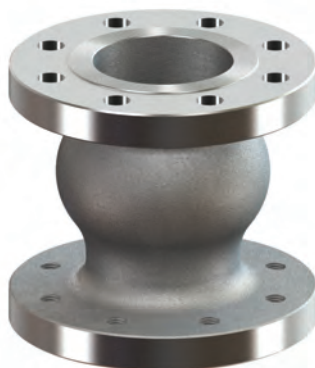

MEP990-4DFM  
Bell Housing

Accessories / Repair Kits	
Part No.	Description
MEP990-4DFM	4" - 300LB Double Flange ESV / ISC Bell Housing Conversion Kit - fits ME990S-4DFM
MEP990-6DFM	6" - 300LB Double Flange ESV / ISC Bell Housing Conversion Kit - fits ME990S-6DFM



Excelerator Railcar Emergency Shutoff Valves (ESV's) are designed to provide rapid and positive shutdown of gas lines should a downstream rupture or piping break occur during product transfer. Featuring a built-in fusible element at the valve operating hub to ensure the ESV will automatically close when exposed to heat between 212° F. - 250° F. In addition to the fusible element, the Excelerator Railcar ESV's are equipped with a poppet design similar the MEC internal safety valves that provides an integral excess flow feature. MEC offers a variety of closing flow values ranging from very high liquid flow rates to more moderate vapor flow rates depending on the application. MEC Excelerator Railcar ESV's are equipped standard with quick disconnect internal pneumatic operators for rapid and reliable open/close of the poppet allowing for convenient on site or remote shutdown of the valve.

## FEATURES

- 316 Stainless Steel Body
- All stainless steel internal component construction provides maximum corrosion resistance
- Hardened stainless steel flanged end connection for durability and ease of field service
-  Listed for use with LP Gas and Anhydrous Ammonia - 400 PSI WOG
- Integral fusible element for automatic closure when exposed to fire
- Durable PTFE packing gland with resilient seals providing long lasting service life
- 100% field repairable - no special tools required
- E-Z grip ribs for installation even with heavy protective hand wear

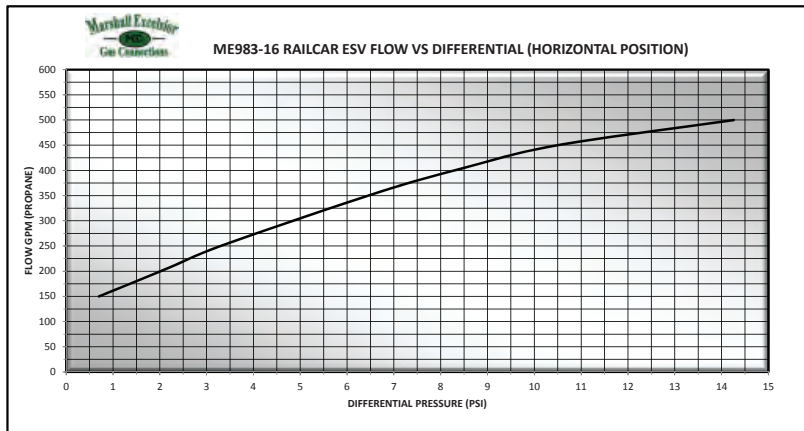

ME983 Series



Part No.	Description	Closing Flow GPM/LPG
ME983-16/150	High Flow Railcar ESV 2" FNPT X 2" FNPT	150*
ME983-16/250	High Flow Railcar ESV 2" FNPT X 2" FNPT	250
ME983-16/500	High Flow Railcar ESV 2" FNPT X 2" FNPT	500
ME983-16	High Flow Railcar ESV 2" FNPT X 2" FNPT	~

\* Recommended for vapor service - approx. closing flow 71,000 SCFH/LPG  
 ~ Available with Kalrez, Viton and Neoprene seal materials  
 ~ For NH3 multiply GPM by .90



# FLOW INDICATING SWING CHECK VALVES

Promotes maximum pump efficiency by providing system operators with a visual inspection point for monitoring liquid flow conditions as well as providing a soft seat back check valve to prevent reverse product flow. Installation of a flow indicating swing check valve upstream of the pump allows the operator to observe product flow and make pump adjustments for maximum flow without cavitation. Suitable for stationary and mobile applications.



## FEATURES

- Powder coated ductile iron body for maximum durability
- Removable flanged ends for ease of field service
- Integral swing away check valve with soft seat to promote maximum product flow and prevent reverse product flow
- All stainless steel internal component construction provides maximum corrosion resistance
- Magnetically coupled flow indicator for maximum protection against leaks and minimal resistance to product flow
- Clear/Easy to read flow indicator with “Glow” arrow allows the operator to easily see if the valve is open or closed
-  LISTED for use with LP Gas and Anhydrous Ammonia - 400 PSI WOG



Part No.	Description	Material	Flange Material	OAL
ME981-6	3/4" FNPT Flow Indicating Check Valve	Ductile Iron		4-3/4"
ME981-8	1" FNPT Flow Indicating Check Valve	Ductile Iron		4-3/4"
ME981-10	1-1/4" FNPT Flow Indicating Check Valve	Ductile Iron	Ductile Iron	5-3/8"
ME981-16	2" FNPT Flow Indicating Check Valve	Ductile Iron	Cast Steel	6-7/8"
ME981-24	3" FNPT Flow Indicating Check Valve	Ductile Iron	Ductile Iron	9-5/8"
ME982-10	1-1/4" FNPT Non-Indicating Check Valve	Ductile Iron	Ductile Iron	5-3/8"
ME982-16	2" FNPT Non-Indicating Check Valve	Ductile Iron	Cast Steel	6-7/8"
ME982-24	3" FNPT Non-Indicating Check Valve	Ductile Iron	Ductile Iron	9-5/8"
ME981-16-2F	2" - 300 lb. Flange Flow Indicating Check Valve	Ductile Iron	Ductile Iron	11-7/8"
ME981-24-3F	3" - 300 lb. Flange Flow Indicating Check Valve	Ductile Iron	Ductile Iron	14-1/8"
ME981-24-4F	4" - 300 lb. Flange Flow Indicating Check Valve	Ductile Iron	Ductile Iron	14-1/4"
ME982-16-2F	2" - 300 lb. Flange Flow Non-Indicating Check Valve	Ductile Iron	Ductile Iron	11-7/8"
ME982-24-3F	3" - 300 lb. Flange Flow Non-Indicating Check Valve	Ductile Iron	Ductile Iron	14-1/8"
ME982-24-4F	4" - 300 lb. Flange Flow Non-Indicating Check Valve	Ductile Iron	Ductile Iron	14-1/4"



# SIGHT FLOW SWING CHECK VALVE

Designed with the most durable, impact resistant glass in the industry. This sight flow valve allows bulk plant operators an inspection point to visually monitor liquid flow conditions which allows the operator to achieve maximum pump efficiency. Also features a soft seat swing away check valve which limits flow to one direction. This check valve is usually closed until pressure activates the valve when flow is directed into piping or containers causing the valve to open. When flow stops or reverses, the check returns to the closed position minimizing product loss in the event of a line failure.

Installing a sight flow valve upstream of a plant pump, allows the operator to observe product flow and make pump adjustments for maximum flow without the liquid forming vapor bubbles causing uneven flow patterns and significantly reducing efficiency. Additionally, installing a sight flow valve at the loading arm of a plant allows the operator to maintain consistent observation of pump conditions. This valve is suitable for stationary and mobile applications.

Installing this valve on a compressor operation will provide a visual indication of when the tank car or transport is emptied of liquid and ready for vapor recovery.

## FEATURES

- Specially formulated, large diameter impact resistant sight glass with O-ring packing seals for maximum safety and visibility
- Durable ductile iron body with cadmium plated finish
- All steel and stainless steel construction
- Rated up to 400 PSI / WOG
- Hexagon cast ends for ease of installation

Part No.*	Inlet & Outlet FNPT	Seal Material	OAL
ME875S-16	2"	Nitrile	5-3/4"
ME875SN-16	2"	Neoprene	5-3/4"
ME875SV-16	2"	Viton®	5-3/4"
ME875S-24	3"	Nitrile	7-3/8"
ME875SN-24	3"	Neoprene	7-3/8"
ME875SV-24	3"	Viton®	7-3/8"

\* "NC" indicates no check e.i. ME875SNC-16

Viton® is a trademark of DuPont Performance Elastomers.



# Y-STRAINERS

Designed for flow in one direction to guard against debris in pipelines that could cause damage to pumps, valves or other equipment. Can be installed horizontally or vertically. They are available in three stainless steel mesh sizes. The mesh size equals the number of holes per square inch i.e. the smaller the number the larger the holes.

A shutoff valve installed on the filter basket outlet allows for convenient blow-off cleaning of Y-Strainer while under pressure. The ME656S Series Ductile Iron Strainers are available in 3" or 4" -300LB ANSI flange sizes with threaded blow-off ports. All strainers come standard with 40 mesh stainless steel reinforced screens for maximum durability and protection of downstream equipment. Plugs for the threaded blow-offs are available at additional cost.\*



## FEATURES

- Durable ductile iron body with automotive grade powder coat finish
- Rated 600 PSI / WOG
- Optional factory installed plug\*
- Designed for LP-Gas or NH<sub>3</sub>



**ME656S-3F-901**  
ME656S-3F  
Replacement Screen

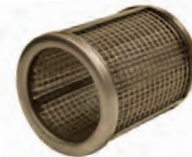

See replacement parts section

Part No.			Blow-Off Plug Size	Inlet & Outlet FNPT
20 Mesh Screen	40 Mesh Screen	80 Mesh Screen		
ME650S/20	ME650S	ME650S/80	1/2"	1/2"
ME651S/20	ME651S	ME651S/80	1/2"	3/4"
ME652S/20	ME652S	ME652S/80	3/4"	1"
ME653S/20	ME653S	ME653S/80	3/4"	1-1/4"
—	ME654S	—	1"	1-1/2"
ME655S/20	ME655S	ME655S/80	1"	2"
—	ME656S	ME656S/80	1-1/4"	3"
—	ME656S-3F	—	1-1/4"	3"-300 LB Flange
—	ME656S-4F	—	1-1/4"	4"-300 LB Flange

\*To add a factory installed plug use a "P" after the prefix number i.e. ME650SP/20



# PIPEAWAY ADAPTERS

Designed to be installed between semi-internal pressure relief valves and vent stacks or at any point in plant plumbing where breakaway protection is needed. This plated steel adapter has a weak section to help protect the relief valve if vent stack is damaged or to help protect plant plumbing from catastrophic failure.

Part No.	Inlet & Outlet	Material
MEP104-24	3" FNPT	Steel



# BREAKAWAY BULK HEAD ADAPTERS

Designed to be installed on the station head or at any point in plant plumbing where breakaway protection is needed. Internal hex broach allows for easy removal from plumbing if broken off.

Part No.	Inlet & Outlet	Material
ME870-6-1	3/4" NPT	Brass
ME870-10-1	1-1/4" NPT	Brass
ME870-16-01	2" NPT	Brass

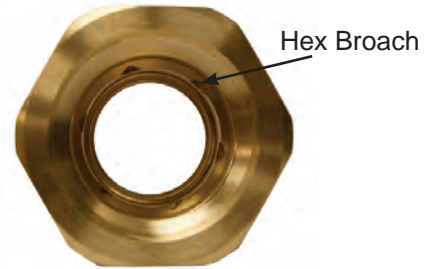

ME870-16-01

# CLAMP STYLE HOSE COUPLINGS

These hose couplings are user friendly and can be easily installed in the field. A steel or ductile hose barb is inserted into the hose and two outer clamps, positioned on the outside of the hose, have a boss to keep the bolts from rotating while the clamps compress the hose for a leak free seal.

**NOTE:** Clamps must be installed with clamp lip fully engaged into flange groove on hose barb body.

## FEATURES

- Hose barb constructed of zinc plated steel or ductile iron with automotive grade powder coat finish
- All hose clamps are ductile iron with automotive grade powder coat finish
- Optional integrated female Acme swivel eliminates weight of additional couplings
- Includes hose barb and two clamps, nuts and bolts

Part No.	Hose Barb	Outlet MNPT
ME3162-08	1/2"	1/2"
ME3162-12	3/4"	3/4"
ME3162-12S	3/4"	1-3/4" F. Acme Steel
ME3162-1216	3/4"	1"
ME3162-16	1"	1"
ME3162-16S	1"	1-3/4" F. Acme Steel
ME3162-1612	1"	1-1/4"
ME3162-2016	1-1/4"	1"
ME3162-20	1-1/4"	1-1/4"
ME3162-2018S	1-1/4"	1-3/4" F. Acme Steel
ME3162-2020S	1-1/4"	2/1/4" F. Acme Steel
ME3162-24	1-1/2"	1-1/2"
ME3162-24S	1-1/2"	2-1/4" F. Acme Steel
ME3162-32	2"	2"
ME3162-32B*	2"	3-1/4" F. Acme Brass
ME3162-32S	2"	3-1/4" F. Acme Steel

\* Rated for LP-Gas



ME3162-32B



ME3162-32S



ME3162-20





# BREAKAWAY COUPLINGS

Designed to provide a safe way to transfer LP-Gas and NH<sub>3</sub> without sacrificing flow. The **FloKill™** Breakaway Coupling flows both directions and protects against expensive loss of product or equipment damage if a pull-away occurs during a transfer operation. One end of the breakaway coupling should be attached to a fixed or sturdy point. In the event of an excessive amount of pull force, the breakaway coupling will separate and immediately shutoff product flow in both directions.

To reconnect the valve, pressure needs to be relieved from both ends of the line, therefore it is recommended that a safe way to bleed down the line is provided upstream and downstream. After the lines have been depressurized use Marshall Excelsior's re-installation tool (MEP128-6) for 3/4" or slide the male end into the female side and pull the collar back until they lock. After reconnection the line must be tested using Marshall Excelsior Leak Detector to check for leaks before any product is transferred. The breakaway coupling may be used on vapor or liquid lines on transports, delivery trucks, motor fuel containers, fill cabinets and other miscellaneous filling operations.

**NOTE:** It is recommended that breakaway couplings be safety tested monthly to confirm that proper separation occurs in the event of a pull-away. Dry air is suggested for a source of pressure during testing.

### FEATURES

- Nitrile soft seat provides positive shutoff both upstream and downstream of source
- 100—300 lbs of force required for disconnect
- Approximately 100 lbs of force to reconnect
- Large internal bore for increased flow
- Durable plated steel construction
- Rated for LP-Gas & NH<sub>3</sub>



ME860S-6



ME861S-6

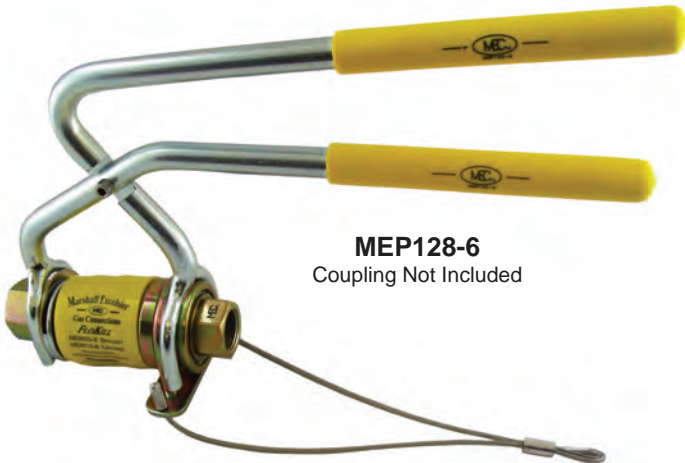

MEP128-6  
Coupling Not Included

Part No.		Connection FNPT	OAL Length	Accessory
Bracket Style	Lanyard Style			Reassembly Tool
ME860S-6	ME861S-6	3/4"	6"	MEP128-6
ME860S-8	ME861S-8	1"	6-3/4"	—
ME860S-10	ME861S-10	1-1/4"	7-3/4"	—



# FILLER AND VAPOR COUPLINGS

These couplings are used as connections between the hose and transfer valve. The filler coupling is designed to provide different connections for the end of a hose (inlet) or an angle, globe or quick acting valve (outlet) when transferring liquid. The vapor coupling is designed to be used with valves having an upper check mechanism. The nose piece on the vapor coupling opens the check valve allowing vapor equalization.

The extended style has a stainless steel female Acme nut insert cast into the heavy duty aluminum handle. All filler and vapor couplings come with a factory installed retaining ring unless noted. The retaining ring limits the travel of the handle or nut during disconnect reducing spin-offs and promoting proper venting of the captured product.



ME130S

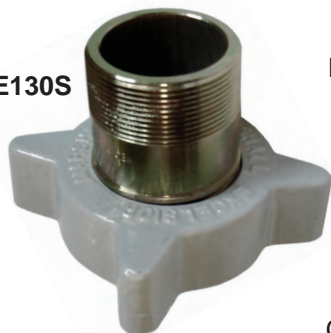

Wing Nut

Knurled Nut

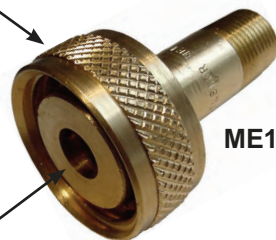

ME110

Filler Coupling

ME130A



ME150

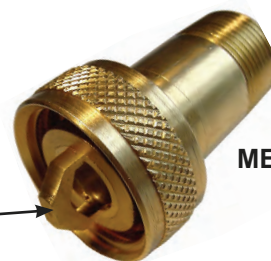

Vapor Coupling

Extended Styles

Heavy Duty Aluminum Standard Handle



ME635 Series



ME635G Series

Heavy Duty Aluminum Fluted Handle

Service Type		Part No.						F. Acme	MNPT	
		Brass		Brass Wing Nut/Steel Nipple	Steel*					
		Knurled Nut	Wing Nut		Knurled Nut	Wing Nut	Extended Handle			
						Standard	Fluted			
Liquid		ME100	—	—	—	—	—	—	1-1/4"	3/8"
		ME101	—	—	—	—	—	—	1-1/4"	1/2"
		ME110	ME110C	—	—	—	ME635-4	ME635G-4	1-3/4"	1/2"
		ME111	ME111C	—	ME111S	ME111SC	ME635-6	ME635G-6	1-3/4"	3/4"
		—	—	—	—	ME113SC	—	—	1-3/4"	3/4" FNPT
		ME112	ME112C	—	ME112S	ME112SC	ME635-8	ME635G-8	1-3/4"	1"
		—	—	—	—	—	ME635-10	ME635G-10	1-3/4"	1-1/4"
		—	ME120** ME120WR	ME120S** ME120SWR	—	ME121S** ME121SWR	—	—	2-1/4"	1-1/4"
Vapor		—	ME130B** ME130BWR	ME130** ME130A*** ME130WR	—	ME130S** ME130SWR	—	—	3-1/4"	2"
		ME140	—	—	—	—	—	—	1-1/4"	3/8"
		ME141	—	—	ME141S	—	—	—	1-1/4"	1/2"
		—	—	—	—	—	ME646-4	ME646G-4	1-3/4"	1/2"
		ME150	ME150C	—	ME150S	ME150SC	ME646-6	ME646G-6	1-3/4"	3/4"
		ME151	ME151C	—	ME151S	ME151SC	ME646-8	ME646G-8	1-3/4"	1"
		—	—	—	—	—	ME646-10	ME646G-10	1-3/4"	1-1/4"
		—	—	ME160	—	ME160S	—	—	2-1/4"	1-1/4"

\* Rated for LP-Gas & NH<sub>3</sub>  
 \*\* Does not include a factory installed retaining ring  
 \*\*\* Includes factory installed filter screen  
 Pressure rated for 400 WOG



# ACME ADAPTERS

Part No.			M. Acme	FNPT	MNPT
Brass		Steel*			
No Screen	Factory Installed Screen				
ME498-4/2	—	—	1-1/4"	1/4"	1/2" **
ME498-6/3	—	—	1-1/4"	3/8"	3/4" **
ME192	—	—	1-1/4"	1/2"	—
ME193	—	—	1-1/4"	3/4"	—
ME210	—	—	1-3/4"	1/4"	—
ME211	—	—	1-3/4"	3/8"	—
ME212	—	—	1-3/4"	1/2"	—
ME213	—	ME213S	1-3/4"	3/4"	—
ME214	—	ME214S	1-3/4"	1"	—
ME502-12/8	—	—	2-1/4"	1"	1-1/2" **
ME502-16/10	—	ME502S-16/10	2-1/4"	1-1/4"	2" **
ME502-16/12	—	—	2-1/4"	1-1/2"	2" **
ME250	ME250A	—	3-1/4"	1-1/4"	—
ME251	ME251A	—	3-1/4"	1-1/2"	—
ME252-16	ME252A-16	ME252S-16	3-1/4"	2"	—
ME508-24	ME508A-24	ME508S-24	3-1/4"	3"	—

\* Rated for LP-Gas & NH<sub>3</sub>  
 \*\* Male Thread Outside & Female Thread Inside  
 Pressure rated for 400 WOG



ME192



ME212



ME252S-16



ME503J-16

1/4" FNPT with Vent Valve & #54 Orifice



ME503JB-16

Brass Vent Valve



ME503JS-16

Stainless Steel Vent Valve

Part No.						M. Acme	FNPT/ MNPT
Brass			Steel*				
Factory Machined 1/4" FNPT with Vent Hole	Factory Installed Brass Vent Valve	Factory Installed Stainless Steel Vent Valve	Factory Machined 1/4" FNPT with Vent Hole	Factory Installed Brass Vent Valve	Factory Installed Stainless Steel Vent Valve		
ME252J-16	ME252JB-16	ME252JS-16	ME252SJ-16	ME252SJB-16	ME252SJS-16	3-1/4"	2" FNPT
ME503J-16	ME503JB-16	ME503JS-16	ME503SJ-16	ME503SJB-16	ME503SJS-16	3-1/4"	2" MNPT

To add a factory installed screen use an "A" after the prefix number i.e. ME252AJB-16  
 \* Rated for LP-Gas & NH<sub>3</sub>  
 Pressure rated for 400 WOG



# ACME ADAPTERS

Part No.					M. Acme	MNPT	FNPT
Brass		Steel *					
No Screen	1/8" FNPT Side Port	Factory Installed Screen	No Screen	1/8" FNPT Side Port			
ME498-4/2	—	—	—	—	1-1/4"	1/2"	1/4" **
ME498-6/3	—	—	—	—	1-1/4"	3/4"	3/8" **
—	—	—	ME520S-8	—	1-1/4"	1"	—
—	—	—	ME521S-4	—	1-3/4"	1/2"	—
ME215	—	—	ME215S	—	1-3/4"	3/4"	—
ME216	—	—	ME216S	—	1-3/4"	1"	—
ME217	ME217J	ME217A	ME217S	ME217SJ	1-3/4"	1-1/4"	—
ME233	ME233J	—	ME233S	ME233SJ	2-1/4"	1-1/4"	—
ME502-12/8	—	—	—	—	2-1/4"	1-1/2"	1" **
ME502-16/10	—	—	ME502S-16/10	—	2-1/4"	2"	1-1/4" **
ME502-16/12	—	—	—	—	2-1/4"	2"	1-1/2" **
ME503-16	—	ME503A-16	ME503S-16	—	3-1/4"	2"	—
ME503-20	—	ME503A-20	—	—	3-1/4"	2-1/2"	—
ME262	—	ME262A	ME262S	—	3-1/4"	3"	—

\* Rated for LP-Gas & NH<sub>3</sub>  
 \*\* Male Thread Outside & Female Thread Inside  
 Pressure rated for 400 WOG



ME215S

ME503-16



ME233S

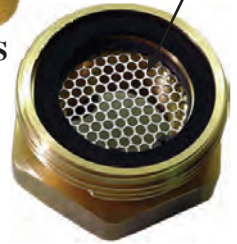

Acme Adapter with Screen



MEP503



MEP503K Installed (ME503-16 not included)



Part No.		M. Acme	Female UNC Thread
Brass	Steel*		
ME209	ME209S	1-3/4"	3/8"-16

To hold hose end valve secure when not in use  
 \* Rated for LP-Gas & NH<sub>3</sub>

Part No.	Description
MEP503	Conical Filter Screen only for 3-1/4" M Acme Adapters 30 Mesh - Stainless Steel
MEP503K	Conical Filter Screen and Retainer for 3-1/4" M Acme Adapters 30 Mesh - Stainless Steel



Part No.		M. Acme	M. Acme
Brass	Steel *		
ME270	—	1-1/4"	1-1/4"
ME273	ME273S	1-3/4"	1-3/4"
ME275	ME275S	2-1/4"	2-1/4"
ME277	ME277S	3-1/4"	3-1/4"

\* Rated for LP-Gas & NH<sub>3</sub>

# ACME REDUCER COUPLINGS



ME442

Part No.		F. Acme	M. Acme
Brass	Steel *		
ME611	ME611S	2-1/4"	1-3/4"
ME612	ME612S	3-1/4"	1-3/4"
ME614	ME614S	3-1/4"	2-1/4"
ME442	ME442S	3-1/4"	1-1/4" FNPT

\* Rated for LP-Gas & NH<sub>3</sub>  
 Pressure rated for 400 WOG



ME612S



# ACME CAPS



**ME229-EL**  
1-3/4" F. Acme x  
1/2" Male Flare  
90°



**ME441RS**

**ME441F-1**  
Chain Included

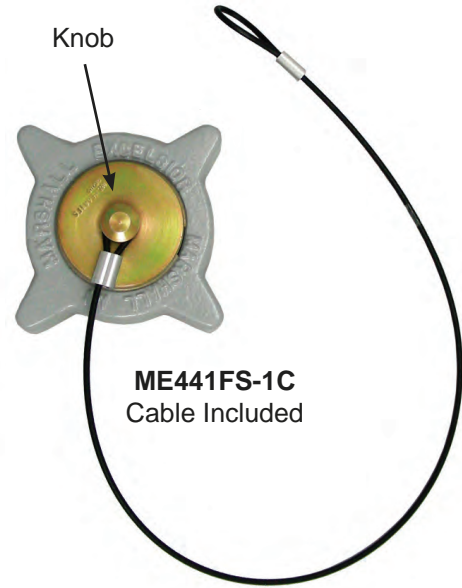

**ME441FS-1C**  
Cable Included



Part No.						F. Acme	Style	Accessory	
Brass			Steel *					Chain Only**	Cable Only
Cap Only	Cap with Chain	Cap with Cable	Cap Only	Cap with Chain	Cap with Cable				
ME229	ME229-1	—	ME229S	ME229S-1	—	1-3/4"	Pin Hole	MEP148	—
ME229F	ME229F-1	ME229F-1C	ME229FS	ME229FS-1	ME229FS-1C	1-3/4"	Knob	MEP167	MEP168
ME431F	ME431F-1	—	ME431FS	ME431FS-1	—	2-1/4"	Knob	MEP167	MEP168
ME431R	ME431R-1	—	—	—	—	2-1/4"	Tapped Hole	MEP167	MEP168
ME441F	ME441F-1	ME441F-1C	ME441FS	ME441FS-1	ME441FS-1C	3-1/4"	Knob	MEP167	MEP168
ME441R	ME441R-1	—	ME441RS	ME441RS-1	—	3-1/4"	Tapped Hole	MEP167	MEP168

\* Rated for LP-Gas & NH<sub>3</sub>  
 \*\* MEP147 ring fits over 3/4" MNPT—MEP148 ring fits over 1-1/4" MNPT  
 Note: Red and Yellow versions available upon request



**ME106**

Part No.		F. Acme	Style	Accessory
Plastic				Chain Only**
Cap Only	Cap with Chain			
<b>ME108</b>	ME108-1	1-1/4"	Pin Hole	MEP147
<b>ME109 or ME109-NH3*</b>	ME109-1 or ME109-NH3-1*	1-3/4"	Pin Hole	MEP148
<b>ME106</b>	ME106-1	3-1/4"	Pin Hole	—

\* Rated for NH<sub>3</sub>  
 \*\* MEP147 ring fits over 3/4" MNPT—MEP148 ring fits over 1-1/4" MNPT



**ME109-NH3**



# ACME CAPS WITH FLANGE

The flange allows for easy operation of pneumatic or proximity interlock switches which control the safety systems of transport vehicles. The stainless steel flange is flush mounted to the Acme cap.

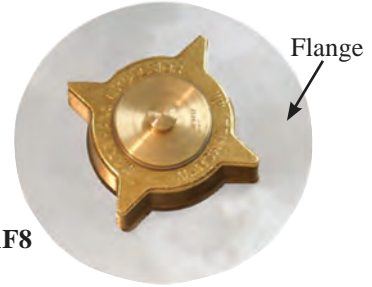

ME441F8



Part No.						F. Acme	Style	Flange Diameter	Accessory	
Brass			Steel *						Chain Only	Cable Only
Cap with Flange	Cap with Flange & Chain	Cap with Flange & Cable	Cap with Flange	Cap with Flange & Chain	Cap with Flange & Cable					
ME229F5	ME229F5-1	ME229F5-1C	ME229FS5	ME229FS5-1	ME229FS5-1C	1-3/4"	Knob	5"	MEP167	MEP168
ME441F8	ME441F8-1	ME441F8-1C	ME441FS8	ME441FS8-1	ME441FS8-1C	3-1/4"	Knob	8"	MEP167	MEP168
ME441R8	ME441R8-1	—	—	—	—	3-1/4"	Tapped Hole	8"	MEP167	MEP168

\* Rated for LP-Gas & NH<sub>3</sub>

# HEAVY DUTY ACME SPANNER WRENCHES

EZ-Turn Ergonomic Aluminum Acme spanner wrench for 3-1/4" female Acme caps.



MEP120C

Part No.	Length
MEP120C	13-3/4"

Aluminum Acme spanner wrench for 1-3/4", 2-1/4", 3-1/4" and 4-1/4" female Acme caps.

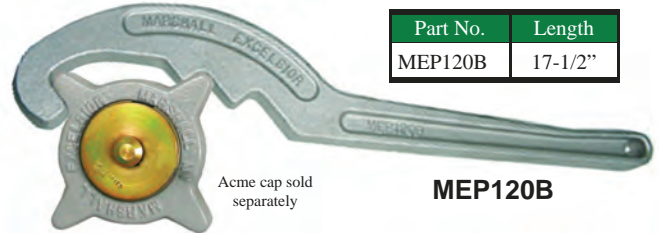

Part No.	Length
MEP120B	17-1/2"

MEP120B

Acme cap sold separately

# ACME DUST PLUGS

Part No.									M. Acme
Aluminum			Brass			Plastic			
Plug Only	Chain Only*	Plug with Chain	Plug Only	Chain Only*	Plug with Chain	Plug Only	Chain Only*	Plug with Chain	
—	—	—	ME178B	MEP148	ME178B-1	ME178	MEP147	ME178-1	1-1/4"
ME239	MEP148	ME239-1	ME179B	MEP148	ME179B-1	ME179	MEP148	ME179-1	1-3/4"
—	—	—	ME180B	MEP167	ME180B-1	ME180	MEP148	ME180-1	2-1/4"
—	—	—	ME181B	MEP167	ME181B-1	ME181	MEP183	ME181-1	3-1/4"

\* MEP147 ring fits over 3/4" MNPT—MEP148 ring fits over 1-1/4" MNPT

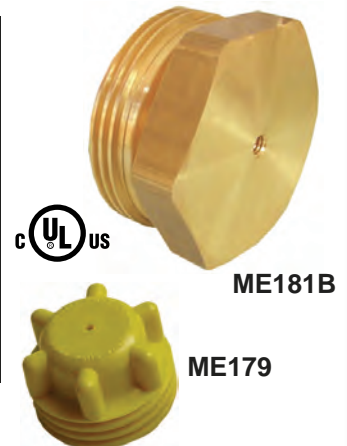

ME181B

ME179



## WHEEL CHOCK

Designed with a “Double Grip” handle for easy carrying and dual traction grips for the road and tire. The cast aluminum construction makes the wheel chock lightweight while still able to withstand the toughest environments. Turn the wheel chock upside down and the points on top of the wheel chock will dig into the snow, ice and mud to prevent sliding. Durable safety yellow powder coat finish.



Part No.	Height	Length	Width
ME200	7"	10"	7"

## WHEEL CHOCK BRACKET

Designed to provide a durable and convenient receptacle to store wheel chocks during over-the-road transit. Durable aluminum construction and molded inserts prevent damage to wheel chocks. For installations that require additional mounting clearance a standoff extension kit is available.

Part No.	Height	Length	Depth	Wheel Chocks Included	Accessory
					Standoff Extension Kit
ME200B	7-3/4"	20"	7"	No	ME200EXT
ME200BK	9-3/4"	20"	8"	Yes	



## UNIVERSAL UTILITY BRACKET

Provides a safe and secure method to mount and retain hand tools such as shovels, picks, brooms or other equipment for bobtail or utility vehicles during over the road transit.

### FEATURES

- Cast aluminum body for maximum durability
- Vinyl coated for maximum security
- All stainless steel spring and mounting hardware

Part No.	Description
MEP082	Universal Spring Loaded Utility Bracket



# CONTAINER THERMOMETERS

Part No.	Dial Diameter	Probe Length
MEJ700	2"	4"
MEJ701	2"	6"
MEJ702	3"	4"
MEJ703	3"	6"

Designed for use in LP-Gas or NH<sub>3</sub> storage tanks, nurse tanks, bobtails and transports. These stainless steel, dust and water proof thermometers feature a 1/2" MNPT connection with a temperature range from -40° to +120° Fahrenheit. Accuracy +/- 1 percent full range.



## PRESSURE GAUGES

Designed to measure the pressure of gas or liquid. Marshall Excelsior offers two types of gauges, dry and glycerin filled. The dry gauge is the most commonly used and least expensive gauge. With a glycerin filled gauge, the life of the gauge is extended, vibration of the pointer is minimized and condensation, caused by humid air inside the gauge, is eliminated.

To determine the correct gauge, environment along with normal operating system pressure must be considered. The pressure range of the gauge should be twice the normal system pressure to maximize gauge life and accuracy.

Part No.		PSIG	Dial Size	Fill Type
1/4" MNPT Bottom Mount	1/4" MNPT Back Mount			
MEJ520	—	0-5	2-1/2"	Dry
MEJ500	MEJ510	0-15	2"	Dry
MEJ603LP-01*	—	0-15	2-1/2"	Glycerin
MEJ501	MEJ511	0-30	2"	Dry
ME10BTK-04	—	0-30	2-1/2"	Glycerin
ME50ECO-2	—	0-30" WC	2-1/2"	Dry
MEJ502	MEJ512	0-60	2"	Dry
MEJ503	MEJ513	0-100	2"	Dry
MEJ504	—	0-160	2"	Dry
MEJ505	—	0-200	2"	Dry
MEJ600-02	MEJ516	0-300	2"	Dry
MEJ603HP-01*	—	0-300	2-1/2"	Glycerin
MEJ580***	—	0-300	4"	Dry
MEJ542**	—	0-400	2-1/2"	Glycerin
—	MEJ524*	0-400	2-1/2"	Glycerin
MEJ552*	MEJ526**	0-400	2-1/2"	Glycerin

\* Brass Pipe Thread; Stainless Steel Dial  
 \*\* Stainless Steel Gauge      \*\*\* Plated Steel Gauge



## PRESSURE GAUGE PROTECTIVE BOOT

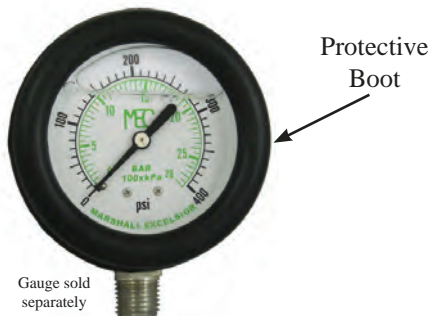

Designed to fit over the pressure gauge dial to extend the life and accuracy of dry and liquid pressure gauges. This boot helps protect the dry pressure gauge's fragile internal components and helps prevent dents on liquid pressure gauges which cause the gauge to leak.

Part No.	Fits
MEJ2.5GB	2-1/2" Dial, Bottom Mount Pressure Gauge





## PRESSURE GAUGE SNUBBERS

Designed for a pressure gauge to be threaded into the outlet of the snubber. The snubber will reduce pressure fluctuations that can over pressurize or damage the gauge while maintaining a quick response time and a steady reading.

Part No.	Material	Style	Inlet (MNPT)	Outlet (FNPT)
ME202	Brass	#54 Orifice	1/4"	1/4"
ME202SS	Stainless Steel	#54 Orifice	1/4"	1/4"
ME204	Brass	Sintered Metal Filter Disc	1/4"	1/4"



ME202SS



ME204

## THERMAL FUSE PLUGS

MEC fuse plugs are designed to release when exposed to fire ranging from 212-250° F. Ideal for air controlled remote release air operated actuator systems.

Part No.	NTP	Material	Hex	OAL
ME205-013	1/8" MPT	Brass	7/16"	.5906"
ME206-09	3/8" MPT	Brass	3/4"	.75"



ME205-013

## SERVICEMAN'S REPLACEMENT SEAL KIT

Designed to provide a convenient storage system for all common LP-Gas and NH<sub>3</sub> gaskets and O-rings. Perfect for dispenser cabinets or bobtail and transport drivers.

### FEATURES

- Durable ABS plastic container with storage latch
- Preformed insert with individual spaces for each gasket/O-ring size
- Labeled with each gasket/O-ring size and part number for easy identification and reorder purposes
- All gaskets/O-rings manufactured from  approved compounds for LP-Gas and NH<sub>3</sub> services



MEW1

MEW1—Serviceman's Replacement Seal Kit Includes:	Qty	Replacement Part No.
1-1/4" Acme Motor Fuel Flat Gasket	9	MEW4
1-1/4" Acme Flat Gasket	10	MEW3
1-3/4" Acme Flat Gasket	10	MEW2
2-1/4" Acme Flat Gasket	10	MEW5
3-1/4" Acme Flat Gasket	10	MEW6
Male Motor Fuel Connector O-ring	12	ME220M-02
POL O-ring	12	568-110-01



MEW1 Layout



# HOSE REEL CONTROL SWITCH COVERS

These covers are intended to protect Hannay® Hose Reel Control Switches from moisture and/or other contaminants during over-the-road transit. The MEP-GMC1 is specifically designed to fit Hannay® Guidemaster® control switches while the MEP-RDC1 is specifically designed to fit Hannay® red DOT EPS style control switches. Both of these covers fit snugly over the control to help prevent damage due to moisture or other contaminants thereby increasing the longevity of the control switch.

## FEATURES

- Made with durable UV stable black low temperature EPDM material
- Includes security lanyard to help prevent loss of the cap
- Fits Hannay® Guidemaster® and red DOT EPS switches
- Control switch can be operated through cover without removing



MEP-RDC1



Part No.	Description	Material
MEP-GMC1	Hose Reel Control Switch Cover for Guidemaster® Control Arm	Black EPDM
MEP-RDC1	Hose Reel Control Switch Cover for Red DOT EPS	Black EPDM

\* "Hannay®" and "Guidemaster®" are trademarks of Hannay Reels

# PRESSURE GAUGES

Intended for application where precise control of gas output is required. These precision machined valves offer a wide range of adjustment without stem galling. Perfect for isolating pressure gauges from bulk storage containers or upstream shutoff valves for torches and/ or outdoor burner applications.

## FEATURES

- Available in brass, plated steel & stainless steel construction
- Tapered valve body seat & stem for precision accuracy
- Various inlet / outlet configurations available
- ME831 & ME834 series valves approved for bi-directional flow



Part No.	Description	Material
ME831	Needle Valve 1/4" MNPT x 1/4" FNPT	Brass
ME832	Needle Valve 1/4" MNPT Outlet x #80 Orifice 1"- 20 F. Inlet	Brass
ME833	Needle Valve 1/4" MNPT Outlet x 1"- 20 F. Inlet	Brass
ME834	Needle Valve 1/4" MNPT x 9/16" -18 LH Male	Brass
ME831S	Needle Valve 1/4" MNPT x 1/4" FNPT	Plated Steel
ME831SS	Needle Valve 1/4" MNPT x 1/4" FNPT	Stainless Steel



# VENT VALVES

Marshall Excelsior is the only manufacturer in the industry that offers three types of vent valves—**Low Emission, Self-Cleaning Low Emission, and Standard Vent Valves**. All the vent valves below are designed to minimize loss of product while allowing the operator to effectively bleed down connections and detect liquid levels while filling containers. Vent valves provide an effective means to verify valves have closed in the transfer system when installed into the downstream auxiliary port on the Marshall Excelsior globe and angle valves. Opening the vent valve until liquid or vapor stops venting indicates it is safe to disconnect.

All brass versions have knurled stems that completely unscrew from the valve making the stems replaceable. The stainless steel version has a t-handle stem that is non-removable.

The **Low Emission Vent Valve** and the **Self-Cleaning Low Emission Vent Valve** reduce emissions by **70 Percent** during normal container filling operations. The **Self-Cleaning Low Emission Vent Valve** cleans out the orifice hole each time it is operated. The hole is cleaned out with a #54 orifice drill that reams the valve's orifice hole each time the adjusting screw is loosened or tightened, eliminating nuisance orifice clogging. The reduced venting emissions is achieved by forcing product to pass between the #54 orifice hole and the flutes of the captured self-cleaning apparatus. The self-cleaning replacement screw (MEJ401SC) is compatible with all existing standard vent valve bodies allowing a standard vent valve to be converted into a self-cleaning low emission vent valve without reinstalling the valve body.

The **Standard Vent Valve** has a #54 orifice with no self-cleaning apparatus.

The **Low Emission Vent Valve** has a #72 orifice.

## FEATURES

- 70% emission reduction with our Self-Cleaning and Low Emission vent valves
- 1/4" MNPT Connection
- Available with dip tubes. See fixed maximum liquid level gauges

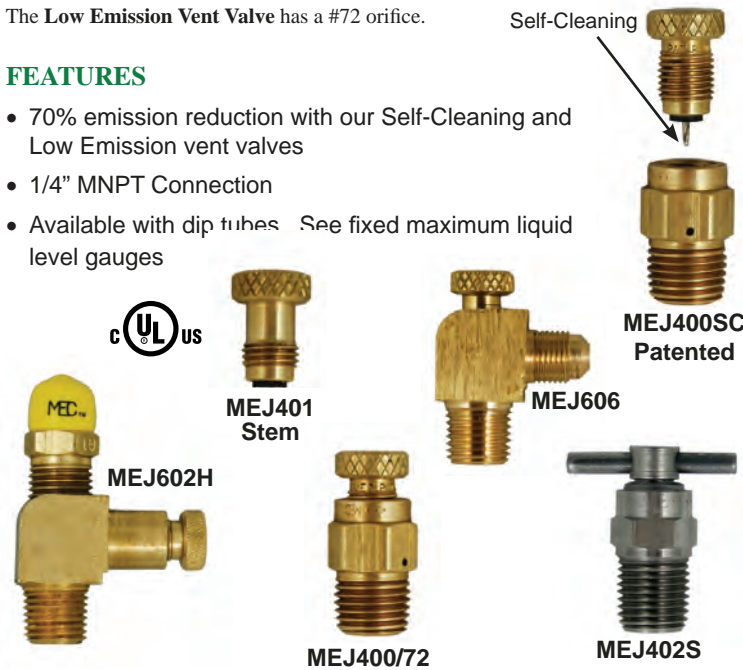

Type	Part No.		
	Brass	Brass Replacement Stems	Stainless Steel*
Low Emission #72 Orifice	MEJ400/72	MEJ401	—
Self-Cleaning Low Emission #54 Orifice	MEJ400SC	MEJ401SC	—
Standard #54 Orifice	MEJ400	MEJ401 MEJ401SC	MEJ402S
Captured Stem Standard #54 Orifice	MEJ400C	—	—
90° Elbow w/ Hydrostatic Relief	MEJ602H***	MEJ400 MEJ401 MEJ401SC	—
90° Elbow 1/4" MPT x 1/4" M. Flare	MEJ606	MEJ400 MEJ401 MEJ401SC	—

\* Rated for LP-Gas & NH<sub>3</sub>  
 \*\* With Bleeder Valve  
 \*\*\* Factory Installed Vent Valve

## FIXED MAXIMUM LIQUID LEVEL GAUGES

Designed to provide a way to visually determine that a tank has reached maximum allowable fill capacity. The dip tube end of a fixed liquid level gauge should be set equal to 80% of the liquid level tank capacity and installed in the vapor space of the tank. The vent valve should be opened before filling begins during which time vapor will be discharged. Once the tank reaches maximum liquid fill capacity (80% of tank capacity), liquid will begin to discharge from the vent valve telling the operator the tank has reached maximum allowable fill capacity and the filling operation should cease immediately.

Type	Part No.					
	5.4" Tube Length Brass	5.7" Tube Length Brass	6.6" Tube Length Brass	6.9" Tube Length Brass	12" Tube Length Brass	12" Tube Length Stainless Steel*
Low Emission #72 Orifice	MEJ410/72-5.4	MEJ410/72-5.7	MEJ410/72-6.6	MEJ410/72-6.9	MEJ410/72-120	—
Self-Cleaning Low Emission #54 Orifice	MEJ410SC-5.4	MEJ410SC-5.7	MEJ410SC-6.6	MEJ410SC-6.9	MEJ410SC-120	—
#54 Orifice	MEJ410-5.4	MEJ410-5.7	MEJ410-6.6	MEJ410-6.9	MEJ410-120	MEJ402S-120
Captured Stem #54 Orifice	MEJ410C-5.4	MEJ410C-5.7	MEJ410C-6.6	MEJ410C-6.9	MEJ410C-120	—

\* Rated for LP-Gas & NH<sub>3</sub>



# LIQUID TRANSFER VALVES

This system provides a safe and economical way to evacuate liquid from a tank during an emergency or container relocation. Installing a Liquid Withdrawal Tank Valve (ME460 or ME462 Series) directly into a tank, allows you to have only one Liquid Transfer Shutoff Valve (ME449 or ME449S) attached to a Liquid Withdrawal Adapter (ME458 Series) on every delivery and service truck.

## Opening Liquid Withdrawal Tank Valve

1. Slowly loosen cap to release any trapped LP-Gas thru relief hole. Remove the cap when venting stops. In case of a leak and venting does not stop, retighten the cap and use another approved method to withdraw the liquid. *When loosening the cap make sure the valve is not unthreading from the tank. Use two wrenches, if necessary, to secure the valve to the tank.*
2. The Liquid Transfer Shutoff Valve must be in the open position and securely attached to the Liquid Withdrawal Adapter before connecting to the Liquid Withdrawal Tank Valve.
3. Once the Shutoff Valve Assembly is tightly attached to the Tank Valve, close the Shutoff Valve Assembly. A popping sound actuating the Tank Valve will occur while closing the Shutoff Valve Assembly allowing the flow to be controlled by the Shutoff Assembly. *If the Tank Valve does not open after following steps 1-3, increase pressure downstream (Shutoff Valve side) to equalize pressure in the Tank Valve.*
4. Use Marshall Excelsior Leak Detector to check for leaks between each connection.

## Closing Liquid Withdrawal Tank Valve

1. To shut the Tank Valve pressure in the tank must exceed 35 psig. Close the Shutoff Valve Assembly and disconnect the hose or piping.
2. Slowly open the Shutoff Valve Assembly to release any LP-Gas in the valve. If the tank pressure exceeds 35 psig the LP-Gas released to the air will cause the excess flow feature to close on the Tank Valve. If the Tank Valve does not completely shut, close the Shutoff Valve Assembly immediately. The Shutoff Valve Assembly must remain connected until all the LP-Gas can be removed and the container repaired.
3. After the Tank Valve excess flow feature has closed remove the Shutoff Valve Assembly. When disconnecting the assembly make sure the Tank Valve is not unthreading from the tank. Use two wrenches, if necessary, to secure the valve to the tank. Note: A small amount of bypass may occur through the excess flow check. Use caution when removing the Shutoff Valve Assembly.
4. Clean the top surface of the Tank Valve and place Tank Valve Cap back onto Tank Valve ensuring cap gasket is in place. Make sure the Tank Cap is placed tightly onto the Tank Valve.

**NOTE:** Always use an adapter between the liquid transfer valve (ME449 Series) and the liquid withdrawal valve. Do not use the transfer valve and adapter for full time service. Extreme care must be used whenever liquid transfer of LP-Gas is in progress. Only persons trained in the proper method of transfer should attempt this type of operation. Reference NFPA #58 Liquefied Petroleum Gas Code Chapter 7, LP-Gas Liquid Transfer for additional information.



Liquid Transfer Shutoff Valve  
ME449  
ME449S



Liquid Withdrawal Adapter  
ME458

ME458S



Liquid Withdrawal Tank Valve  
ME462

ME462S  
ME462SS



ME461 Series  
Cap included

Liquid Withdrawal Tank Valve Cap  
ME461

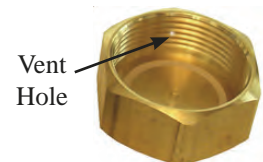

# LIQUID TRANSFER VALVES & ADAPTERS

Designed to provide a safe means by which to transfer liquid from a tank during an emergency or container relocation. These valves can be equipped with an integral excess flow device for direct product transfer or without when used in conjunction with liquid withdrawal adapter (ME458 Series) and tank valve (ME460 & ME462 Series).

**WARNING:** An excess flow valve will not activate if there is a break or leak downstream of the valve that does not equal or exceed the closing flow of the valve or if the excess flow valve installed exceeds the flow capacity of the system. See the **Excess Flow Warning** page for more information regarding the use of excess flow devices.

## LIQUID TRANSFER VALVE FEATURES

- Double O-ring stem seal design ensures leak free operation
- Double lead stem thread ensures quick and efficient operation
- 3/4" MNPT inlet x 3/4" FNPT outlet
- Additional features for steel transfer valves
  - All stainless steel internal components
  - Durable ductile iron valve body with automotive grade powder coat finish
  - Equipped with convenient upstream and downstream 1/4" FNPT plugged ports for optional accessories



## TANK VALVE FEATURES

- Provides excess flow protection in the event of a downstream connection or line failure
- Safety breakaway feature leaves valve seals intact in the event of truck roll-away
- 6-14 psig closing flow pressure differential for maximum product transfer
- Fully interchangeable with all existing valve models and adapters
- Additional features for steel and stainless steel tank valves
  - Meets requirements for installation into DOT storage containers like bobtails and transports
  - Steel model features a rust inhibitor compound between the cap and body threads to prevent corrosion



Part No.	Material	Excess Flow	Closing Flow/GPM	Accessories								
				Liquid Withdrawal Adapter 3/4" FNPT x 1-5/8" UNF		Liquid Withdrawal Tank Valve 1-5/8" UNF Male				Hydrostatic Relief Valve	Vent Valve	Excess Flow Check Valve
				Brass	Steel*	3/4" MNPT		1-1/4" MNPT				
						Brass	Brass	Steel*	Stainless Steel*			
ME449	Brass	No	—	ME458	ME458S	ME460***	ME462***	—	—	MEH225 MEH25/450	ME449X-110-KIT	
ME449H	Brass	No	—	ME458	ME458S	—	—	—	—	Factory Installed MEH225		
ME449S	Ductile Iron*	No	—	—	ME458S	—	—	ME462S***	ME462SS***	MEH225SS/350 MEH225SS/400 MEH225SS/440	MEJ400 MEJ400SC MEJ400/72 MEJ402S	
ME449EXS/22	Ductile Iron*	Yes	22	—	—	—	—	—	—		—	
ME449EXS/28	Ductile Iron*	Yes	28	—	—	—	—	—	—		—	
ME449X/19.5	Brass	Yes	19.5	—	—	—	—	—	—	—	ME449X-110-KIT	
ME450**	Brass	No	—	—	—	ME601-6	ME601-10	—	—	—	—	

\* Rated for LP-Gas & NH<sub>3</sub>

\*\* MEJ400 Vent Valve Factory Installed

\*\*\* Includes an excess flow feature (ME460 = 21 GPM / ME462 = 36 GPM)



# LIQUID TRANSFER ADAPTERS

Designed for use between the liquid transfer shutoff valve and the liquid withdrawal tank valve. These adapters enable the tank valve to open properly and allows a tight seal when transferring liquid. Special threads on the tank valve and the adapter help eliminate tampering.

The ME458 Series fits all new underwriters laboratories listed valves. The ME453 and ME455 fit older style liquid withdrawal tank valves that are still in service and have not been replaced. They will not provide a positive seal during actuation of liquid withdrawal tank valve until fully seated.

Part No.	Material	Inlet Connection	Outlet Connection
ME458	Brass	1-5/8" UNF	3/4" FNPT
ME458S*	Steel	1-5/8" UNF	3/4" FNPT
ME453	Brass	3/4" NGT	3/4" FNPT
ME455	Brass	3/4" NGT	3/4" MNPT

\* Rated for LP-Gas & NH<sub>3</sub>



ME453



ME455



ME458

# COMBINATION VALVES

Developed to mount a pressure gauge and fixed tube liquid level gauge all in one valve. The shutoff portion of the valve increases the pressure gauge's life and accuracy by eliminating constant gauge pressure and allows for easy gauge replacement. To replace a gauge simply close the valve and open the vent valve to relieve pressure before disassembling pressure gauge.

The valve can be installed at the maximum fill level or an 1/8" MNPT dip tube can be installed on the container connection side to set any liquid level desired. For use in ASME bulk storage containers and DOT transport tank installations.

## FEATURES

- All steel and stainless steel component construction
- Integral #54 orifice provides gauge dampening protection
- Durable ductile iron body with automotive grade powder coat finish or plated steel body



**UL**  
For LP-Gas & NH<sub>3</sub>

ME830

MEP449S-101  
Replacement Protective  
Weather Boot



MEJ415G



MEJ415

Part No.	Material	Container Connection MNPT	Two Service Connections FNPT	Dip Tube Connection FNPT	Accessories	
					Stainless Steel Vent Valve	Stainless Steel 0-400 PSIG Pressure Gauge
ME830	Ductile Iron	3/4" MNPT	1/4" FNPT	1/8"	Included	MEJ526 MEJ542
MEJ415	Steel	3/4" MNPT	1/4" FNPT	1/8"	MEJ402S	MEJ542
MEJ415G	Steel	3/4" MNPT	1/4" FNPT	1/8"	Included	Included



# LIFT TRUCK FLOAT GAUGE

for DOT HORIZONTAL or  
VERTICAL TANK ORIENTATION



**MES-FG1284-001U**  
Lift Truck Float Gauge  
(Junior Head Mounting)



- 1-1/4" NPT or junior head mounting
- Refer to ordering information for correct gauge
- Junior mounting head includes gasket

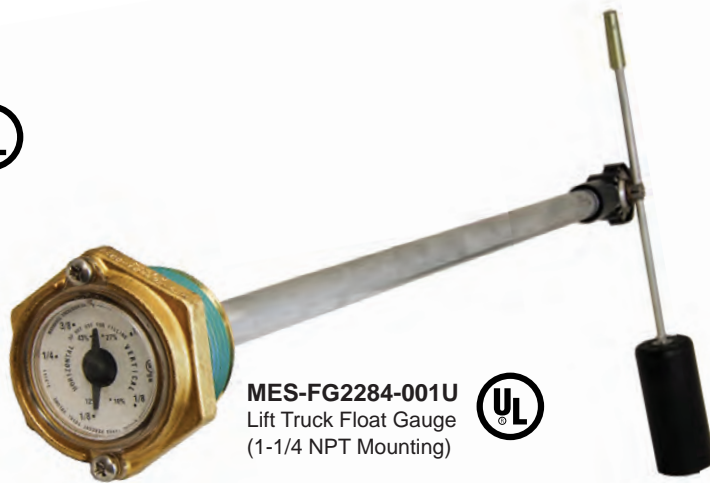

**MES-FG2284-001U**  
Lift Truck Float Gauge  
(1-1/4 NPT Mounting)



## FEATURES

- Solid brass mounting head - **LPG SERVICE ONLY**
- Ultra low friction, smooth acting, non-jamming gear design
- Hermetically sealed, easy to read dial
- Teflon® coated, free-floating shaft
- Solid float; no metal shell to corrode or leak
- Pre-applied thread sealant on NPT versions

Part No.	Propane Capacity and Mounting Style	Nominal Cylinder Diameter	Gauge Head Style	Replacement Dial w/ 2 Mounting Screws
MES-FG1284-001U	33-1/2 lb. universal	12"	Junior Brass Head	MES-1284-20-001-KIT
MES-FG2184-001U	33-1/2 lb. universal	12"	Threaded 3/4" NPT Brass Head	MES-2184-20-001-KIT
MES-FG2284-001U	33-1/2 lb. universal	12"	Threaded 1-1/4" NPT Brass Head	MES-1284-20-001-KIT



# 1" NPT ABOVE GROUND FLOAT GAUGES

## for ASME ABOVE GROUND HORIZONTAL DOMESTIC TANKS & DOT CYLINDERS

- REMOTE READY
- 1" NPT mounting
- Refer to ordering information for correct size gauge
- For various size tanks



MES-FG3981 Series  
1" NPT AG Float Gauges



### FEATURES

- Solid brass mounting head - **LPG SERVICE ONLY**
- Ultra low friction, smooth acting, non-jamming gear design
- Hermetically sealed, easy to read dial
- Teflon® coated, free-floating shaft
- Solid float; no metal shell to corrode or leak

Part No.	Container Capacity (Gallons of Water)	Nominal Cylinder Diameter	Gauge Head Style	Remote Ready Replacement Dial w/ 2 Mounting Screws	Standard Replacement Dial w/ 2 Mounting Screws
MES-FG3981-002R	120	24"	Threaded 1" NPT Brass Head	MES-1284-20-002R-KIT	MES-1284-20-002-KIT
	150				
MES-FG3981-003R	200	30"	Threaded 1" NPT Brass Head	MES-1284-20-002R-KIT	MES-1284-20-002-KIT
	250				
	325				
MES-FG3981-004R	500	37"	Threaded 1" NPT Brass Head	MES-1284-20-002R-KIT	MES-1284-20-002-KIT
MES-FG3981-005R	1000	41"	Threaded 1" NPT Brass Head	MES-1284-20-002R-KIT	MES-1284-20-002-KIT
MES-FG3981-001R*	420# vertical	30"	Threaded 1" NPT Brass Head	MES-1284-20-003R-KIT (% of total volume)	MES-1284-20-003-KIT (% of total volume)





# ACCU-MAX™ FLOAT GAUGES

## for ABOVE GROUND HORIZONTAL DOMESTIC TANKS

- REMOTE READY
- 1-1/4" NPT mounting
- Refer to ordering information for correct size gauge
- For various size tanks

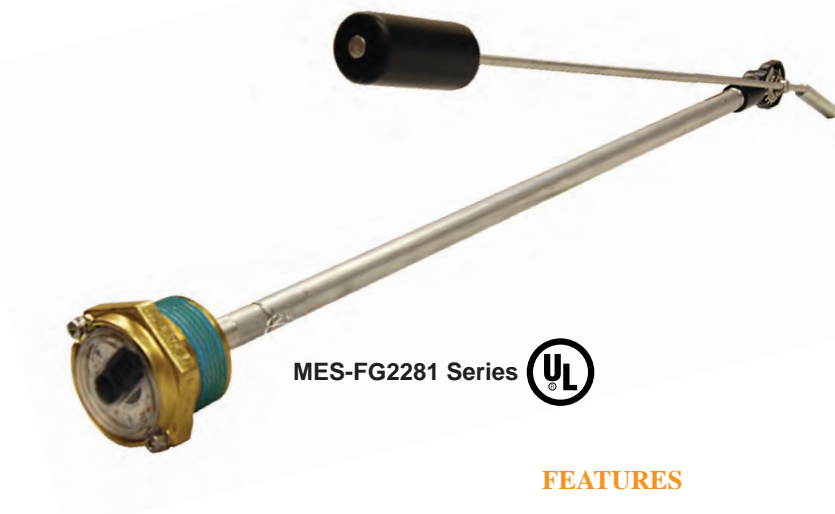

### FEATURES

- Solid brass mounting head - **LPG SERVICE ONLY**
- Ultra low friction, smooth acting, non-jamming gear design
- Hermetically sealed, easy to read dial
- Teflon® coated, free-floating shaft
- Solid float; no metal shell to corrode or leak

Part No.	Container Capacity (Gallons of Water)	Nominal Cylinder Diameter	Gauge Head Style	Remote Ready Replacement Dial w/ 2 Mounting Screws	Standard Replacement Dial w/ 2 Mounting Screws
MES-FG2281-001R	120	24"	Threaded 1-1/4" NPT Brass Head	MES-1284-20-002R-KIT	MES-1284-20-002-KIT
	150				
MES-FG2281-002R	200	30"	Threaded 1-1/4" NPT Brass Head	MES-1284-20-002R-KIT	MES-1284-20-002-KIT
	250				
	325				
MES-FG2281-003R	500	37"	Threaded 1-1/4" NPT Brass Head	MES-1284-20-002R-KIT	MES-1284-20-002-KIT
MES-FG2281-004R	1000	41"	Threaded 1-1/4" NPT Brass Head	MES-1284-20-002R-KIT	MES-1284-20-002-KIT



# ACCU-MAX™ FLOAT GAUGES

## for ASME ABOVE GROUND HORIZONTAL DOMESTIC TANKS

- REMOTE READY
- Brass junior head mounting
- Refer to ordering information for correct size gauge
- Gasket included



### FEATURES

- Solid brass mounting head - **LPG SERVICE ONLY**
- Ultra low friction, smooth acting, non-jamming gear design
- Hermetically sealed, easy to read dial
- Teflon® coated, free-floating shaft
- Solid float; no metal shell to corrode or leak
- Standard with remote ready dial

Part No.	Container Capacity (Gallons of Water)	Nominal Cylinder Diameter	Remote Ready Replacement Dial w/ 2 Mounting Screws	Standard Replacement Dial w/ 2 Mounting Screws
MES-FG1280-001R	120	24"	MES-1284-20-002R-KIT	MES-1284-20-002-KIT
	150			
MES-FG1280-002R	200	30"	MES-1284-20-002R-KIT	MES-1284-20-002-KIT
	250			
	325			
MES-FG1280-003R	500	37"	MES-1284-20-002R-KIT	MES-1284-20-002-KIT
MES-FG1280-004R	1000	41"	MES-1284-20-002R-KIT	MES-1284-20-002-KIT

# JUNIOR UNDERGROUND FLOAT GAUGES

## for UNDERGROUND HORIZONTAL DOMESTIC TANKS

- REMOTE READY
- Brass junior head mounting
- Refer to ordering information for correct size gauge
- Gasket included



**MES-FG1281 SERIES**  
Junior UG Float Gauges

### FEATURES

- Solid brass mounting head - **LPG SERVICE ONLY**
- Ultra low friction, smooth acting, non-jamming gear design
- Hermetically sealed, easy to read dial
- Teflon® coated, free-floating shaft
- Solid float; no metal shell to corrode or leak

Part No.	Container Capacity (Gallons of Water)	Nominal Cylinder Diameter	Gauge Head Style	Gauge Riser Lengths	Remote Ready Replacement Dial w/ 2 Mounting Screws	Standard Replacement Dial w/ 2 Mounting Screws
MES-FG1281-001R	120	24"	Junior brass head	8-1/2"	MES-1284-20-002R-KIT	MES-1284-20-002-KIT
	150					
MES-FG1281-002R	200	30"		8-1/2"	MES-1284-20-002R-KIT	MES-1284-20-002-KIT
	250					
	325					
MES-FG1281-003R	500	37"		8-1/2"	MES-1284-20-002R-KIT	MES-1284-20-002-KIT
MES-FG1281-004R	1000	41"		8-1/2"	MES-1284-20-002R-KIT	MES-1284-20-002-KIT
MES-FG1281-005R	120	24"		15-1/2"	MES-1284-20-002R-KIT	MES-1284-20-002-KIT
	150					
MES-FG1281-006R	200	30"		15-1/2"	MES-1284-20-002R-KIT	MES-1284-20-002-KIT
	250					
	325					
MES-FG1281-007R	500	37"		15-1/2"	MES-1284-20-002R-KIT	MES-1284-20-002-KIT



# ACCU-MAX™ FLOAT GAUGES

ACCU-MAX™ FLOAT GAUGES

Designed to measure liquid levels within horizontal DOT and Stationary ASME Tanks with fluid capacities above 2,300 gallons. For maximum gauge life, the float arm features an integral spring loaded shock absorber for harsh over-the-road applications. The standard dial face features a black background for reduced glare with glow technology providing an easy to read “glow in the dark” dial face, perfect for low light situations. An optional classical style dial face is available. These gauges are suitable for use in bobtail, transport, railcar and bulk storage applications.

**NOTE:** These gauges must be installed on the centerline of the tank’s side or end for accurate readings.

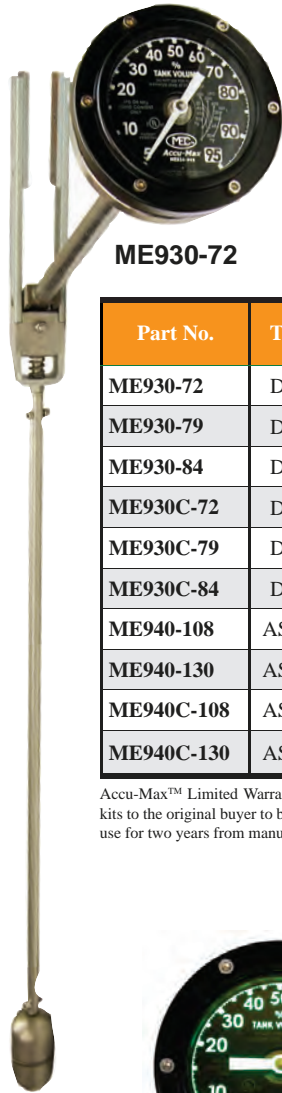

ME930-72

Part No.	Type	Style	Dial Face	Dial Size	Tank Diameter
ME930-72	DOT	Standard	Glow/Black	4”	72”
ME930-79	DOT	Standard	Glow/Black	4”	79”
ME930-84	DOT	Standard	Glow/Black	4”	84”
ME930C-72	DOT	Classic	Silver/Black	4”	72”
ME930C-79	DOT	Classic	Silver/Black	4”	79”
ME930C-84	DOT	Classic	Silver/Black	4”	84”
ME940-108	ASME	Standard	Glow/Black	8”	108”
ME940-130	ASME	Standard	Glow/Black	8”	130”
ME940C-108	ASME	Classic	Silver/Black	8”	108”
ME940C-130	ASME	Classic	Silver/Black	8”	130”

## FEATURES

- All stainless steel construction
- Welded tube to coupling design for maximum strength and durability
- Dial face 100% sealed and argon filled to prevent moisture build-up & fogging
- Factory set and precision tuned for superb accuracy
- Dial face and mounting hardware universal with other industry standard gauges
- Mounts to all standard 8 bolt tank flange adapters
- **Custom length tank configurations available upon request for 30” to 300” I.D. tank**

Accu-Max™ Limited Warranty: Marshall Excelsior warrants Accu-Max™ float gauges and repair kits to the original buyer to be free of defects in material and workmanship under normal service and use for two years from manufactured date.



U.S. and Canada Patented



“Glow” Technology Standard Dial



ME940 ASME Series / 8” Dial Shown as Standard “Glow” Dial



ME930C DOT Series / 4” Dial Shown as Classic Dial

# ACCU-MAX™ FLOAT GAUGE ACCESSORIES

Designed for mounting float gauges in DOT or ASME tanks. These zinc plated steel 8 bolt mounting flanges feature 1/2”-13 threads for easy installation.

Part No.	Connection	Connection
ME931	2-1/2” MNPT	1/2”-13 Female
ME932*	Weld	1/2”-13 Female

\*Weld flanges supplied with material certification



ME931



ME932



# ACCU-MAX™ FLOAT GAUGES

## TRANS-MAX SERIES

Measure liquid levels within horizontal DOT and Stationary ASME Tanks with 1" FNPT tank gauge port openings. Designed to replace rotary style gauges in tanks with fluid capacities greater than 2,300 gallons. Suitable for use in bobtail, transport, and bulk storage applications. MEC exclusive "wedge" design allows for easy installation while greatly reducing time spent inside the vessel.

**NOTE: The heavy duty design of this gauge requires entering vessel through man-way during installation.**



**ME930WG DOT Series  
ME940WG ASME Series**

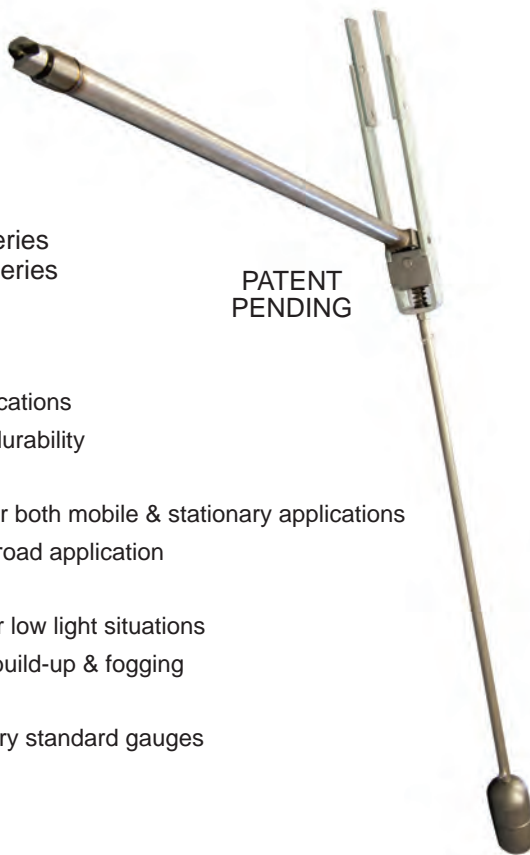

**PATENT  
PENDING**

### FEATURES

- All stainless steel construction for use with LPG & NH<sub>3</sub> applications
- Welded tube to coupling design for maximum strength and durability
- Installation requires man-way
- Converts rotary style gauge to heavy duty Accu-Max style for both mobile & stationary applications
- Integral spring loaded shock absorber for arduous over-the-road application
- Easy to assemble
- Exclusive easy to read "glow in the dark" dial face perfect for low light situations
- Dial face 100% sealed and argon filled to prevent moisture build-up & fogging
- Factory set and precision tuned for superb accuracy
- Dial face and mounting hardware universal with other industry standard gauges
- Mounts to all standard 1" NPT tank coupling adapters
- **Custom lengths available upon request**
- Available with classic style dial face

Trans-Max Accu-Max DOT Float Gauges				
Part No.	Description	Dial Face	Dial Size	Tank Diameter
ME930WG-72	Trans-Max Accu-Max DOT Float Gauge Assembly	Glow/Black	4"	72"
ME930WG-79	Trans-Max Accu-Max DOT Float Gauge Assembly	Glow/Black	4"	79"
ME930WG-84	Trans-Max Accu-Max DOT Float Gauge Assembly	Glow/Black	4"	84"
ME930CWG-72	Trans-Max Accu-Max DOT Float Gauge Assembly (Classic)	Silver/Black	4"	72"
ME930CWG-79	Trans-Max Accu-Max DOT Float Gauge Assembly (Classic)	Silver/Black	4"	79"
ME930CWG-84	Trans-Max Accu-Max DOT Float Gauge Assembly (Classic)	Silver/Black	4"	84"

Trans-Max Accu-Max ASME Stationary Float Gauges				
Part No.	Description	Dial Face	Dial Size	Tank Diameter
ME940WG-108	Trans-Max Accu-Max Stationary Float Gauge Assembly	Glow/Black	8"	108"
ME940WG-130	Trans-Max Accu-Max Stationary Float Gauge Assembly	Glow/Black	8"	130"
ME940CWG-108	Trans-Max Accu-Max Stationary Float Gauge Assembly (Classic)	Silver/Black	8"	108"
ME940CWG-130	Trans-Max Accu-Max Stationary Float Gauge Assembly (Classic)	Silver/Black	8"	130"



# PRESSURE RELIEF VALVE WARNING

## INSPECTION

A pressure relief valve discharges when some extraordinary circumstance causes an over pressure condition in the container. If a pressure relief valve is known to have discharged, the relief valve, as well as the entire system, should be immediately and thoroughly inspected to determine the reason for the discharge. In the case of discharge due to fire, the valve should be removed from service and replaced.

**Relief valves should be inspected each time the container is filled but no less than once a year. If there is any doubt about the condition of the valve, it must be replaced.**

**WARNING:** *Eye protection must be worn when performing inspection on relief valves under pressure. Never look directly into a relief valve under pressure or place any part of your body where the relief valve discharge could impact it. In some cases a flashlight and small mirror are suggested to assist when making visual inspections.*

In the case of a pressure relief valve that has opened due to a pressure beyond its start-to-discharge setting, the chances of foreign material lodging between the seat and the disc is low, however the possibility is always present. If the relief valve continues to leak at pressure below its start-to-discharge setting it must be replaced.

If there is any doubt about the condition of the relief valve, or if the relief valve has not been protected by a cap for some time, it should be replaced before refilling the container.

### Inspection Checklist:

1. **Cap:** Check that the protective cap is in place over the valve or pipeaway stack outlet and has a snug fit. The protective cap helps protect the relief valve against possible malfunction caused by rain, sleet, snow, ice, sand, dirt, pebbles, insects, other debris and contamination. Replace damaged or missing caps at once and keep a cap in place at all times.
2. **Weep Holes:** Inspect and clear debris from the relief valve weep holes. Dirt, ice, paint, and other foreign particles can prevent proper drainage from the valve body. If the weep holes cannot be cleared, replace the valve.

3. **Relief Valve Spring:** Exposure to high concentrations of water, salt, industrial pollutants, chemicals and contaminants could cause metal parts to fail including the relief valve spring. If the coating on the relief valve spring is cracked or chipped, replace the valve.
4. **Physical Damage:** Ice accumulations and improper installation could cause mechanical damage. If there are any indications of damage, replace the valve.
5. **Tampering or Readjustment:** Pressure relief valves are factory set to discharge at specified pressures. If there are any indications of tampering or readjusting, replace the valve.
6. **Seat Leakage:** Check for leaks in the seating area using Marshall Excelsior leak detector solution. If there is any indication of leakage, replace the valve. Never force a relief valve closed and continue to leave it in service. This could result in damage to the valve and possible rupture of the container or piping on which the valve is installed.
7. **Corrosion:** Replace the valve if there are any signs of corrosion or contamination.
8. **Moisture, Foreign Particles or Contaminants in the Valve:** Foreign material such as paint, tar or ice in relief valve parts can impair the proper functioning of the valves. Grease placed in the valve body may harden over time or collect contaminants, thereby impairing the proper operation of the relief valve. Do not place grease in the valve body; replace the valve if there are any indications of moisture or foreign matter in the valve.
9. **Corrosion or Leakage at Container Connection:** Check container to valve connection using Marshall Excelsior leak detector solution. Replace the valve if there is any indication of corrosion or leakage at the connection between the valve and container.

**CAUTION:** *Never plug the outlet of a pressure relief valve. Any device used to stop the flow of a properly operating pressure relief valve that is venting an over pressurized container can cause severe consequences.*

## OPERATION OF PRESSURE RELIEF VALVES

Pressure relief valves are set and sealed by the manufacturer to function at a specific "start-to-discharge" pressure in accordance with UL 132. This set pressure is marked on the relief valve and depends on the design requirement of the container to be protected by the relief valve. If the container pressure reaches the start-to-discharge pressure, the relief valve will open a slight amount as the seat disc begins to move slightly away from the seat. If the pressure continues to rise despite the initial discharge through the relief valve, the seat disc will move to a full open position with a sudden "pop". This popping sound is from which the term "pop-action" is derived.

Whether the relief valve opens a slight amount or pops wide open, it will start to close if the pressure in the container diminishes. After the pressure has decreased sufficiently, the relief valve spring will force the seat disc against the seat tightly enough to prevent any further escape of product. The pressure at which the valve closes tightly is referred to as the "re-seal" or "blow-down" pressure. Generally, the re-seal pressure will be lower than the start-to-discharge pressure.

### Requirements for Pressure Relief Valves

Every container used for storing or hauling LP-Gas and NH<sub>3</sub> must be protected by a pressure relief valve. These valves are designed to protect the container against the development of hazardous conditions which might be created by any of the following:

- High pressures resulting from exposure of the container to excessive external heat.
- High pressures due to the use of incorrect fuel.
- High pressures due to improper purging of the container.

Consult NFPA #58 for LP-Gas and ANSI #K61.1 for NH<sub>3</sub>, and/or any applicable local and state regulations governing the application and use of pressure relief valves.

### Selection of MEC Pressure Relief Valves for ASME Containers

The rate of discharge required for a given container is determined by the calculation of the surface area of the container as shown in "Chart A" for LP-Gas and "Chart B" for NH<sub>3</sub>.

The set pressure of a pressure relief valve depends upon the design pressure of the container. Refer to NFPA #58 "Liquefied Petroleum Gas Code" for more information.



# PRESSURE RELIEF VALVE WARNING

## Chart A - Minimum Required Rate of Discharge for LP-Gas Pressure Relief Valves Used on ASME Containers

From NFPA Code #58, Table 5.7.2.6 (2014 Edition)

Minimum required rate of discharge in cubic feet per minute of air at 120% of the maximum permitted start-to-discharge pressure relief valves to be used on containers other than those constructed in accordance with Interstate Commerce specification.

Surface Area Sq. Ft.	Flow Rate CFM Air	Surface Area Sq. Ft.	Flow Rate CFM Air	Surface Area Sq. Ft.	Flow Rate CFM Air	Surface Area Sq. Ft.	Flow Rate CFM Air	Surface Area Sq. Ft.	Flow Rate CFM Air	Surface Area Sq. Ft.	Flow Rate CFM Air	Surface Area Sq. Ft.	Flow Rate CFM Air
20 or less	626	85	2050	150	3260	230	4630	360	6690	850	13540	1500	21570
25	751	90	2150	155	3350	240	4800	370	6840	900	14190	1550	22160
30	872	95	2240	160	3440	250	4960	380	7000	950	14830	1600	22740
35	990	100	2340	165	3530	260	5130	390	7150	1000	15470	1650	23320
40	1100	105	2440	170	3620	270	5290	400	7300	1050	16100	1700	23900
45	1220	110	2530	175	3700	280	5450	450	8040	1100	16720	1750	24470
50	1330	115	2630	180	3790	290	5610	500	8760	1150	17350	1800	25050
55	1430	120	2720	185	3880	300	5760	550	9470	1200	17960	1850	25620
60	1540	125	2810	190	3960	310	5920	600	10170	1250	18570	1900	26180
65	1640	130	2900	195	4050	320	6080	650	10860	1300	19180	1950	26750
70	1750	135	2990	200	4130	330	6230	700	11550	1350	19780	2000	27310
75	1850	140	3080	210	4300	340	6390	750	12220	1400	20380		
80	1950	145	3170	220	4470	350	6540	800	12880	1450	20980		

**Surface area** = Total outside surface area of container in square feet.

When the surface area is not stamped on the name plate or when the marking is not legible, the area can be calculated by using one of the following formulas:

- Cylindrical container with hemispherical heads. Area (in sq. ft.) = overall length (ft.) x outside diameter (ft.) x 3.1416
- Cylindrical container with other than hemispherical heads. Area (in sq. ft.) = [overall length (ft.) + .3 outside diameter (ft.)] x outside diameter (ft.) x 3.1416.
- Spherical container. Area (in sq. ft.) = outside diameter (ft.) squared x 3.1416.

**Flow Rate CFM Air** = Required flow capacity in cubic feet per minute of air at standard conditions, 60°F. and atmospheric pressure (14.7 psia).

The flow rate discharge may be interpolated for intermediate values of surface

area. For containers with total outside surface area greater than 2000 square feet, the required flow rate can be calculated using the formula. Flow Rate in CFM Air = 53.632 A<sup>0.82</sup>. Where A = total outside surface area of the container in square feet.

Valves not marked "Air" have rate marking in cubic feet per minute of liquefied petroleum gas. These can be converted to ratings in cubic feet per minute of air by multiplying the liquefied petroleum gas ratings by the factors listed below. Air flow ratings can be converted to ratings in cubic feet per minute of liquefied petroleum gas by dividing the air ratings by the factors listed below.

### Air Conversion Factors

Container Type	100	125	150	175	200	
Air Conversion Factor		1.162	1.142	1.113	1.078	1.010

## Chart B - Minimum Required Rate of Discharge for Anhydrous Ammonia Pressure Relief Valves Used on ASME Containers

From ANSI K61.1-1999, Appendix A

Minimum required rate of discharge in cubic feet per minute of air at 120% of the maximum permitted start-to-discharge pressure for pressure relief valves to be used on containers other than those constructed in accordance with United States Department of Transportation cylinder specifications.

Surface Area Sq. Ft.	Flow Rate CFM Air	Surface Area Sq. Ft.	Flow Rate CFM Air	Surface Area Sq. Ft.	Flow Rate CFM Air	Surface Area Sq. Ft.	Flow Rate CFM Air	Surface Area Sq. Ft.	Flow Rate CFM Air	Surface Area Sq. Ft.	Flow Rate CFM Air	Surface Area Sq. Ft.	Flow Rate CFM Air
20 or less	626	85	2050	150	3260	230	4630	360	6690	850	13540	1500	21570
25	751	90	2150	155	3350	240	4800	370	6840	900	14190	1550	22160
30	872	95	2240	160	3440	250	4960	380	7000	950	14830	1600	22740
35	990	100	2340	165	3530	260	5130	390	7150	1000	15470	1650	23320
40	1100	105	2440	170	3620	270	5290	400	7300	1050	16100	1700	23900
45	1220	110	2530	175	3700	280	5450	450	8040	1100	16720	1750	24470
50	1330	115	2630	180	3790	290	5610	500	8760	1150	17350	1800	25050
55	1430	120	2720	185	3880	300	5760	550	9470	1200	17960	1850	25620
60	1540	125	2810	190	3960	310	5920	600	10170	1250	18570	1900	26180
65	1640	130	2900	195	4050	320	6080	650	10860	1300	19180	1950	26750
70	1750	135	2990	200	4130	330	6230	700	11550	1350	19780	2000	27310
75	1850	140	3080	210	4300	340	6390	750	12220	1400	20380		
80	1950	145	3170	220	4470	350	6540	800	12880	1450	20980		

**Surface area** = Total outside surface area of container in square feet.

When the surface area is not stamped on the name plate or when the marking is not legible, the area can be calculated by using one of the following formulas:

- Cylindrical container with hemispherical heads. Area (in sq. ft.) = overall length (ft.) x outside diameter (ft.) x 3.1416
- Cylindrical container with other than hemispherical heads. Area (in sq. ft.) = [overall length (ft.) + .3 outside diameter (ft.)] x outside diameter (ft.) x 3.1416.
- Spherical container. Area (in sq. ft.) = outside diameter (ft.) squared x 3.1416.

**Flow Rate CFM Air** = Required flow capacity in cubic feet per minute of air at standard conditions, 60°F. and atmospheric pressure (14.7 psia).

The rate of discharge may be interpolated for intermediate values of surface area. For containers with total outside surface area greater than 2,500 square feet, the required flow rate can be calculated using the formula, Flow Rate in CFM Air = 22.11 A<sup>0.82</sup> where A = outside surface area of the container in square feet.

### Conversion Factor

$$\begin{aligned} \text{ft}^2 \times 0.092903 &= \text{m}^2 \\ \text{CFM} \times 0.028317 &= \text{m}^3/\text{min} \\ \text{ft} \times 0.3048 &= \text{m} \end{aligned}$$



# PRESSURE RELIEF VALVE WARNING

## INSTALLATION

**WARNING:** Failure to follow these instructions or to properly install and maintain this equipment could result in an explosion and/or fire causing property damage and personal injury or death. Marshall Excelsior Company equipment must be installed, operated and maintained in accordance with all federal, state and local codes and Marshall Excelsior Company instructions. The installation in most states must also comply with NFPA standards 58 and 59, and ANSI K61.1. Only personnel trained in the proper procedures, codes, standards and regulations of the LP-Gas and NH<sub>3</sub> industries should install, maintain and service this equipment.

Be sure all instructions are read and understood before installation, operation and maintenance. These instructions must be passed along to the end user of the product.

**CAUTION:** Contact or inhalation of liquid propane, ammonia and their vapors can cause serious injury or death! NH<sub>3</sub> and LP-Gas must be released outdoors in air currents that will insure dispersion to prevent exposure to people and livestock. LP-Gas must be kept far enough from any open flame or other source of ignition to prevent fire or explosion! LP-Gas is heavier than air and will not disperse or evaporate rapidly if released in still air.

Consult NFPA Codes 58 and 59 / ANSI K61.1 and/or any applicable regulations governing the application and use of pressure relief valves. Make sure you are thoroughly trained before you attempt any valve installation, inspection or maintenance.

Proper installation is essential to the safe operation of pressure relief valves. Install MEC pressure relief valves using the following steps:

1. Check that the valve is clean and free of foreign material in the valve inlet and outlet.
2. Verify that the relief valve start-to-discharge setting and flow rate is correct for the application.
3. Apply a suitable PTFE thread sealant compound to the external NPT threads.
4. Inspect the relief valve inlet and valve seat to ensure no thread sealant or foreign material is present.
5. Install relief valve into container port or manifold using appropriate wrench until leak tight joint is achieved.
6. Check for damage and proper operation after valve installation.
7. After the container is charged with product, check joints for leakage using Marshall Excelsior leak detector.
8. After installation is complete, replace protective cap onto relief valve.

Pipeways and deflectors may be required by local codes, laws and regulations depending on the installation. Use only MEC adapters on MEC relief valves. Adapters not designed specifically for piping away MEC relief valves, such as those with 90° turns will reduce internal diameters, and decrease flow dramatically. These should never be used as they can cause the relief valve to chatter and eventually destroy itself.

**The addition of deflectors, pipeaway adapters and piping will restrict the flow. To properly protect any container, the total system flow must be sufficient to relieve pressure at the pressure setting of the relief valve in accordance with all applicable codes.**

## RELIEF VALVE SAFETY INFORMATION

Repair and Testing: MEC Pressure Relief Valves are tested and listed by Underwriters Laboratories, Inc., in accordance with UL 132 and NFPA Code #58. Construction and performance of MEC Pressure Relief Valves are consistently checked at the factory by UL and ASME audits. Therefore, testing of MEC Pressure Relief Valves in the field is not necessary.

Any pressure relief valves which shows evidence of leakage, other improper operation or is suspect as to its performance must be replaced immediately using approved procedures.

**PIPEAWAY ADAPTERS:** Pipeaway adapters are available for most MEC Pressure Relief Valves, where it is required or desirable to pipe the discharge above or away from the container. Each adapter is designed to sever if excessive stress is applied to the vent piping—thus leaving the relief valve intact and fully operative.

## REPLACEMENT OF PRESSURE RELIEF VALVES

**WARNING:** Under normal conditions, the useful safe service life of a pressure relief valve is 10 years from the original date of manufacture. However, the safe useful life of the valve may be shortened and replacement required in less than 10 years depending on the environment in which the valve lives. Inspection and maintenance of pressure relief valves is very important. Failure to properly inspect and maintain pressure relief valves could result in personal injuries or property damage.

The safe useful life of pressure relief valves can vary greatly depending on the environment in which they live.

Relief valves are required to function under widely varying conditions. Corrosion, aging of the resilient seat disc and friction all proceed at different rates depending upon the nature of the specific environment and application. Gas impurities, product misuse and improper installations can shorten the safe life of a relief valve. The LP-Gas dealer must observe and determine the safe useful life of relief valves in his systems.

For Additional Information Read:

1. NFPA # 58, "Storage and Handling of Liquefied Petroleum Gases".
2. NFPA # 59, "LP-Gases and Utility Gas Plants"

Relief valves in service beyond their service life can exhibit the following degradation in function:

- They may leak at pressures below the set pressure.
- They may open and fail to properly reset.
- They may open at higher than set pressure.

These failures to function properly are due primarily to four "environmental" conditions:

1. Corrosion of metal parts (particularly springs) which result in the component parts failing to perform.
2. Deterioration of synthetic rubber seat disc material.
3. Clogging or "cementing" of the movable relief valve components so that their movement is restricted.
4. Debris on the valve seat after the relief valve opens, effectively preventing the valve from resealing.

Corrosion is caused by water, corrosive atmospheres of salt and high industrial pollutants, chemicals, and contaminants. High concentrations can attack the metal parts vigorously. No suitable metals are totally resistant to such corrosion.

Synthetic rubber and seat disc materials can also be attacked by impurities in the gas and corrosive atmospheres, particularly those with sulphur dioxide. There are no suitable rubber materials which resist all contaminants.

"Cementing" of relief valve parts can be caused by normal industrial atmospheres containing particles of dirt, iron oxide, metal chips, etc. combined with water, oil, or grease. Ice collecting in recessed valves could cause failure to open. Paint and tar in relief valves also cause failure to function properly.

While the functioning of a pressure relief valve appears to be relatively simple, the assembly and test procedure used to manufacture these MEC products is rather complex. Highly specialized test fixtures and specially trained personnel are necessary to attain proper relief valve settings. These fixtures and personnel are available only at the factory.

**WARNING:** Never attempt to repair or change the setting of MEC Pressure Relief Valves. Any changes in settings or repairs in the field will void the MEC warranty and product listings, and may create a serious hazard.



# QUAD-PORT RELIEF VALVE MANIFOLD

Designed for use with large LP-Gas and NH<sub>3</sub> stationary storage containers with flanged openings. These relief manifolds have an additional relief valve excluded from the flow rating, which allows for service and/or exchange of any one relief valve without evacuating the tank. Our large port selection handle allows for each specific valve port to be closed off so that the relief valve may be removed while the remaining valves remain under pressure protecting the tank and contents. Each manifold model is rated based on the flow through the relief valves with one valve removed from service.

## FEATURES

- Heavy duty ductile iron body
- Durable V-cup Teflon® packing stem seals
- Molded rubber weather guard for manifold rotary gear with port plug
- Integral breakaway feature leaves seat and seal intact
- Weep hole deflector and hex socket plugs supplied
- Integrated pilot equalizing feature
- Corrosion resistant finish
- Convenient lifting chain included
- 3-1/2"-8 outlet thread accepts 3" MNPT pipeaway



Large port handle & easy to read port indicators

Part No.	Flange Size	No. of Relief Valves	Application	Flow Capacity SCFM/Air** UL @ 120% Set Pressure	Factory Installed Relief Valve			Accessory 8 Stud / Nut Universal Mounting Kit
					Seal Material*	Start-to-Discharge Setting PSIG	Part No.	
ME903S-3F/250VM	3" - 300# *	3	LPG	20,400 (2)	Viton®	250	MEV250VM/250	ME904SK
ME903S-3F/250CN	3" - 300# *	3	LPG & NH <sub>3</sub>	20,400 (2)	Nitrile	250	MEV250CN/250	ME904SK
ME903S-4F/250VM	4" - 300#	3	LPG	20,400 (2)	Viton®	250	MEV250VM/250	ME904SK
ME903S-4F/250CN	4" - 300#	3	LPG & NH <sub>3</sub>	20,400 (2)	Nitrile	250	MEV250CN/250	ME904SK
ME904S-3F/250VM	3" - 300# *	4	LPG	27,740 (3)	Viton®	250	MEV250VM/250	ME904SK
ME904S-3F/250CN	3" - 300# *	4	LPG & NH <sub>3</sub>	27,740 (3)	Nitrile	250	MEV250CN/250	ME904SK
ME904S-4F/250VM	4" - 300#	4	LPG	27,740 (3)	Viton®	250	MEV250VM/250	ME904SK
ME904S-4F/250CN	4" - 300#	4	LPG & NH <sub>3</sub>	27,740 (3)	Nitrile	250	MEV250CN/250	ME904SK
ME903S-3F/265VM	3" - 300# *	3	LPG	20,555 (2)	Viton®	265	MEV250VM/265	ME904SK
ME903S-3F/265CN	3" - 300# *	3	LPG & NH <sub>3</sub>	20,555 (2)	Nitrile	265	MEV250CN/265	ME904SK
ME903S-4F/265VM	4" - 300#	3	LPG	20,555 (2)	Viton®	265	MEV250VM/265	ME904SK
ME903S-4F/265CN	4" - 300#	3	LPG & NH <sub>3</sub>	20,555 (2)	Nitrile	265	MEV250CN/265	ME904SK
ME904S-3F/265VM	3" - 300# *	4	LPG	28,550 (3)	Viton®	265	MEV250VM/265	ME904SK
ME904S-3F/265CN	3" - 300# *	4	LPG & NH <sub>3</sub>	28,550 (3)	Nitrile	265	MEV250CN/265	ME904SK
ME904S-4F/265VM	4" - 300#	4	LPG	28,550 (3)	Viton®	265	MEV250VM/265	ME904SK
ME904S-4F/265CN	4" - 300#	4	LPG & NH <sub>3</sub>	28,550 (3)	Nitrile	265	MEV250CN/265	ME904SK

\* For use with modified 300 # ANSI Flange with 4" port      \*\* Flow rating based on number of valves indicated in parenthesis ( )  
Flow rates are shown as bare relief valves, pipeaways will reduce flow

Teflon® is a trademark of DuPont Company and Viton® is a trademark of DuPont Performance Elastomers.



# MINI QUAD-PORT RELIEF MANIFOLD

For use with large LPG & NH<sub>3</sub> stationary storage containers with 2" FNPT openings. These Relief Manifolds have an additional relief valve excluded from the flow rating, which allows for service and/or exchange of any one relief valve without evacuating the tank. Our large port selection handle allows for each specific valve port to be closed off so that the relief valve may be removed while the remaining valves stay under pressure protecting the tank and contents. Each manifold model is rated based on the flow through the relief valves with one valve removed from service.



## FEATURES

- Heavy Duty Ductile Iron Body
- All Stainless Steel Internal Components
- Durable Teflon V-Pack Stem Seals
- Large Diameter Port Selection Handle and Port Indicator
- Molded Rubber Weather Guard for Manifold Rotary Gear with Port Plug
- Available with 250 PSIG and 265 PSIG Relief Valve Set Pressures
- Vapor Equalizing Feature for Easy Port to Port Rotation
- Includes Tank Stabilizer Nut for Maximum Strength at Container Connection
- **COVERS MOST 30,000 GALLON TANKS WITH ONLY TWO MANIFOLDS**

Part No.	Relief Valve STD	Application		Tank Connection Size	Relief Valve		***Flow Rating SCFM/AIR @ 120% of set pressure
		LPG	NH <sub>3</sub>		# of Valves	Part No.	UL Rating
ME902S-16B/250	250 PSIG	YES	NO	2" MNPT	2	MEV125B/250	5,115 (1)
ME902S-16/250	250 PSIG	NO	YES	2" MNPT	2	MEV125/250	5,115 (1)
ME902S-16/265	265 PSIG	NO	YES	2" MNPT	2	MEV125/265	5,855 (1)
ME903S-16B/250	250 PSIG	YES	NO	2" MNPT	3	MEV125B/250	9,320 (2)
ME903S-16/250	250 PSIG	NO	YES	2" MNPT	3	MEV125/250	9,320 (2)
ME903S-16/265	265 PSIG	NO	YES	2" MNPT	3	MEV125/265	10,795 (2)
ME904S-16B/250	250 PSIG	YES	NO	2" MNPT	4	MEV125B/250	12,481 (3)
ME904S-16/250	250 PSIG	NO	YES	2" MNPT	4	MEV125/250	12,481 (3)
ME904S-16/265	265 PSIG	NO	YES	2" MNPT	4	MEV125/265	13,630 (3)

\*\*\*Flow rating based on number of valves indicated in parenthesis ( ).  
 Flow rates shown are for bare relief valves, pipeways will reduce flow rates.  
 Note: For 265 PSIG set pressure change part number suffix - i.e. ME903S-16/265  
 To order Viton seal materials add "VM" for Viton® after the prefix part number - i.e. ME904S-16B/250VM

## Accessories

Part No.	Description
MEP178	Pipeaway Adapter for MEV125 Series w/ 2" FNPT Outlet - Aluminum
MEP178K	Pipeaway Adapter Kit w Stabilizer Bracket for ME904S-16
MEP123	Installation / Removal Tool for MEV125 Series Relief Valves



**MEP178K**  
(Pipeaway Adapter & Stabilizer Kit)



# MINI QUAD-PORT TANK SIZING CHART

TANK SIZING REFERENCE CHART							
Part No.	Relief Valve STD	LPG			NH <sub>3</sub>		
		30,000 Gallon 109" O.D.	30,000 Gallon 131" O.D.	18,000 Gallon 109" O.D.	30,000 Gallon 109" O.D.	30,000 Gallon 131" O.D.	18,000 Gallon 109" O.D.
ME902 Series	250 PSIG	N/A	5	3	2	2	2
ME902 Series	265 PSIG	N/A	N/A	3	2	2	2
ME903 Series	250 PSIG	3	3	2	2	1	1
ME903 Series	265 PSIG	3	3	2	2	1	1
ME904 Series	250 PSIG	3	2	2	1	1	1
ME904 Series	265 PSIG	3	2	2	1	1	1

\* Number indicates quantity of relief manifolds to adequately relief vapor overpressure conditions for listed tank surface areas

## MINI QUAD-PORT RELIEF VALVE MANIFOLD

For use with large LPG & NH<sub>3</sub> stationary storage containers with 2" FNPT openings. These Relief Manifolds have an additional relief valve excluded from the flow rating, which allows for service and/or exchange of any one relief valve without evacuating the tank. Our large port selection handle allows for each specific valve port to be closed off so that the relief valve may be removed while the remaining valves stay under pressure protecting the tank and contents. Each manifold model is rated based on the flow through the relief valves with one valve removed from service.

ME904S-16



### FEATURES

- Heavy duty ductile iron body
- All stainless steel internal components
- Durable teflon V-pack stem seals
- Large diameter port selection handle and port indicator
- Molded rubber weather guard for manifold rotary gear with port plug
- Vapor equalizing feature for easy port-to-port rotation
- Includes tank stabilizer nut for maximum strength at container connection

Part No.	Application		Tank Connection Size	Relief Valve Port
	LPG	NH <sub>3</sub>		# of Valves
ME904S-16	Yes	Yes	2" MNPT	1-1/4" FNPT (4)
Accessories				
Part No.	Description		Application	
			LPG	NH <sub>3</sub>
MEV125/250	1-1/4"MNPT External Relief Valve-Nitrile 250PSI - 6,328 SCFM		No	Yes
MEV125/265	1-1/4"MNPT External Relief Valve-Nitrile 265PSI - 6,542 SCFM		No	Yes
MEV125B/250	1-1/4"MNPT External Relief Valve-Nitrile 250PSI - 6,328 SCFM		Yes	No
MEV125B/265	1-1/4"MNPT External Relief Valve-Nitrile 265PSI - 6,542 SCFM		Yes	No



# EXTERNAL PRESSURE RELIEF VALVES

1/4" NPT ~ 1" NPT

Designed for installation in stationary ASME applications such as bulk plant, skid tanks, underground and above ground containers, as the primary pressure relief valve.

**NOTE:** This valve and all working parts are to be installed outside the container. Therefore, to ensure proper operation of the valve, the valve must be protected from damage and inspections performed as prescribed by Marshall Excelsior.



## FEATURES

- Brass construction for LP-Gas application
- Compact design to fit any application
- Stainless steel spring
- Specially designed internal components to increase flow at discharge
- Custom start-to-discharge settings available upon request
- Non-adjustable, tamper resistant design

Part No.	Container Connection	Seal Material*	Start-to-Discharge Setting PSIG	OAL	Wrench Hex	Flow Capacity SCFM/Air** UL @ 120% Set Pressure	Application	Accessories
MEV25/60	1/4" MNPT	Nitrile	60 PSIG	1-59/64"	7/8"	—	LPG	MEP173 Pipeway Adapter
MEV25/250	1/4" MNPT	Nitrile	250 PSIG	1-59/64"	7/8"	—	LPG	
MEV25/312	1/4" MNPT	Nitrile	312 PSIG	1-59/64"	7/8"	—	LPG	
MEV25/375	1/4" MNPT	Nitrile	375 PSIG	1-59/64"	7/8"	—	LPG	
MEV50/250	1/2" MNPT	Nitrile	250 PSIG	2-1/2"	1-1/8"	200	LPG	MEP174 Pipeway Adapter
MEV50/375	1/2" MNPT	Nitrile	375 PSIG	2-1/2"	1-1/8"	—	LPG	
MEV75/250	3/4" MNTP	Nitrile	250 PSIG	2-21/32"	1-1/8"	—	LPG	
MEV75/312	3/4" MNTP	Nitrile	312 PSIG	2-21/32"	1-1/8"	—	LPG	
MEV75/375	3/4" MNTP	Nitrile	375 PSIG	2-21/32"	1-1/8"	—	LPG	MEP173 Pipeway Adapter
MEVS-PVE431B/250	3/4" MNPT	Nitrile	250 PSIG	3-21/64"	1-3/4"	1,740	LPG	
MEVS-PVE431/250	1" MNPT	Nitrile	250 PSIG	4"	1-3/4"	1,740	LPG	

Note: Kalrez option available

\* Nitrile and Kalrez® not UL Listed

\*\* Flow rates are shown for bare relief valves, pipeways will reduce flow

\*\*\* Per NFPA 58, table 5.7.2.5 area shown is for UL or ASME flow rating, which ever is greater

Viton® and Kalrez® are trademarks of DuPont Performance Elastomers.



# EXTERNAL PRESSURE RELIEF VALVES

## 1-1/4" & 2-1/2" NPT

NH<sub>3</sub>



MEV125/250  
(Aluminum)

LPG



MEV125B/250  
(Brass)



**MEV125 Series** - Designed for use with large LPG & NH<sub>3</sub> storage containers as a primary pressure relief valve on ASME above and below ground bulk plant installations. All working components are external to the container connection away from possible product contaminants. Compatible with 1-1/4" FNPT multiple head units including ME902S-16, ME903S-16 & ME904S-16 Series Mini Quad-Port Manifolds.

### FEATURES

- Durable single piece anodized aluminum or brass forged body
- Stainless steel internal components
- Standard Seal Material: HNBR
- Available Seal Material: Viton or Kalrez
- Outlet thread accepts MEP178 pipeaway for 2" FNPT pipeaway
- includes plastic weather cap for relief valve outlet



MEV250VM/250



**MEV250 Series** - Designed for use with storage containers as a primary pressure relief valve on ASME above and below ground installations. All working components and external to the container connection away from possible product contaminants. Compatible with all standard LPG pressure vessels with NPT couplings.

MEP170



MEP250

Part No.	STD/PSIG	Seal Material	Container Connection	OAL	Wrench Hex	Flow Capacity SCFM/AIR ** UL @ 120% set pressure	Suitable for tanks w/ surface area up to: ***	Application		Accessories
								LPG	NH <sub>3</sub>	
MEV125B/250	250 PSIG	Nitrile	1-1/4" MNPT	10-1/2"	2-11/16"	6,330	340 Sq. Ft.	YES	NO	MEV125-109 Replacement Cap
MEV125B/265	265 PSIG	Nitrile	1-1/4" MNPT	10-1/2"	2-11/16"	6,545	350 Sq. Ft.	YES	NO	
MEV125BVM/250	250 PSIG	Viton®	1-1/4" MNPT	10-1/2"	2-11/16"	6,330	340 Sq. Ft.	YES	NO	MEP178 Pipeaway Adapter
MEV125BVM/265	265 PSIG	Viton®	1-1/4" MNPT	10-1/2"	2-11/16"	6,545	350 Sq. Ft.	YES	NO	
MEV125/250	250 PSIG	Nitrile	1-1/4" MNPT	10-1/2"	2-11/16"	6,330	340 Sq. Ft.	YES	YES	MEP123 Installation / Removal Tool
MEV125/265	265 PSIG	Nitrile	1-1/4" MNPT	10-1/2"	2-11/16"	6,545	350 Sq. Ft.	YES	YES	
MEV125VM/250	250 PSIG	Viton®	1-1/4" MNPT	10-1/2"	2-11/16"	6,330	340 Sq. Ft.	YES	NO	MEP170 Relief Valve Adapter
MEV125VM/265	265 PSIG	Viton®	1-1/4" MNPT	10-1/2"	2-11/16"	6,545	350 Sq. Ft.	YES	NO	
MEV250VM/250	250 PSIG	Viton®	2-1/2" MNPT	10-1/2"	4-1/8"	10,333	610 Sq. Ft.	YES	NO	MEP250 Installation/ Removal Tool
MEV250CN/250	250 PSIG	Nitrile	2-1/2" MNPT	10-1/2"	4-1/8"	10,333	610 Sq. Ft.	YES	YES	
MEV250VM/265	265 PSIG	Viton®	2-1/2" MNPT	10-1/2"	4-1/8"	10,948	655 Sq. Ft.	YES	NO	
MEV250CN/265	265 PSIG	Nitrile	2-1/2" MNPT	10-1/2"	4-1/8"	10,948	655 Sq. Ft.	YES	YES	

\*\* Flow rates shown are for bare relief valves, pipeways will reduce flow rates.

\*\*\* Per NFPA pamphlet 58, table 5.7.2.6 area shown is for UL or ASME flow rating, whichever is larger.



# DOT FULL INTERNAL PRESSURE RELIEF VALVES

Designed for use on forklift cylinders and other DOT removable cylinders up to 122 pounds of LP-Gas capacity. The working components of this valve are located inside the tank reducing possible malfunction caused by outside debris or other foreign materials.

**NOTE:** NFPA #58 states, "All containers used in industrial trucks (including fork lift truck cylinders) service shall have the container pressure relief valve replaced by a new or unused valve within 12 years of the date of manufacture of the container and every 10 years thereafter."

## FEATURES

- Stainless steel spring
- Non-adjustable, tamper resistance design
- 45 and 90 degree discharge vents available



Part No.	Container Type	Container Connection	Seal Material*	Start-to-Discharge Setting PSIG	UL Flow Capacity SCFM/ Air** Per CGA S1.1 @ 480 PSIG	Application	Accessories			
							Protective Cap	Relief Valve Plug	Discharge Vents	
									45° Angle	90° Angle
MEV75FIR*	DOT	3/4" MNPT	Viton®	375	368	LPG	MEP175C	MEP175P	MEP175-45	MEP175-90

\* UL Listed in accordance with Compressed Gas Association Pamphlet S-1.1, Pressure Device Standard for Cylinders; Meets requirements for use on DOT containers with 242 lbs. or less weight of water or 122 lbs or less of LP-Gas  
 \*\* Flow rates are shown for bare relief valves, pipeaways will reduce flow

Viton® is a trademark of DuPont Performance Elastomers.



MEVS-UVE445A Series

## FEATURES

- Used as pressure relief device on larger ASME engine fuel containers and recreational vehicle containers
- Use MEVS-PVE445AT on multiport 420-lb. DOT containers
- Protective cap MEPS-UPE16 included
- Supplied with Everseal™ pre-applied thread sealant

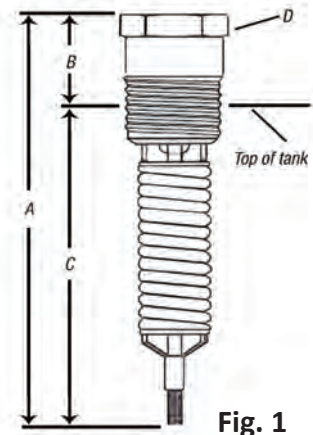

Part No.	STD Setting (PSIG)	Container Connection	Installation Hex	Flow Capacity SCFM/Air **	Tank Surface Area (Sq. Ft.)	Pipeaway Adapter
				UL @ 120% Set Pressure		
MEVS-UVE445AM/250	250	1" MNPT	1-1/16"	987	35	MEPS-445-21
MEVS-PVE445AT/375*	375	1" MNPT	1-1/16"	1625	64	MEPS-445-21

\* MEVS-445AT is classified by Underwriters Laboratories Inc. in accordance with CGA Pamphlet S-1.1.  
 \*\* Flow rates are shown as bare relief valves  
 NOTE: Size relief capacity per NFPA58, table 5.7.2.6

Dimensions (Approx.) - see Fig. 1			
A	B	C	D Hex
5-9/16"	1-3/32"	3-15/32"	1-3/8"



# FULL INTERNAL PRESSURE RELIEF VALVES

Designed for use in mobile LPG & NH<sub>3</sub> containers as a primary pressure relief valve for bobtail and transport trailer installations. All working components are internal to the container connection preventing damage to the valve should a roll-over occur.

## FEATURES

- Durable stainless steel body construction
- All stainless steel internal components for maximum corrosion resistance
- Available with Nitrile, Viton®, or Kalrez® valve seals
- Large seating surface for superior seal performance & reliability.
- Available with 250 & 265 PSI  LISTED set pressures
- Custom set pressures available

MEV200FIR/MEV300FIR

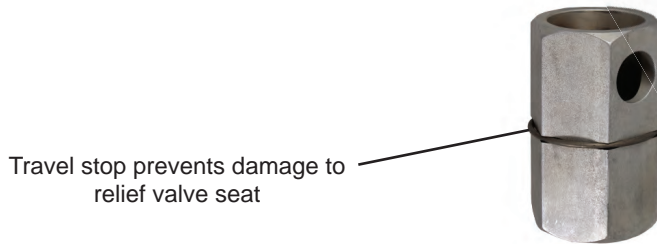
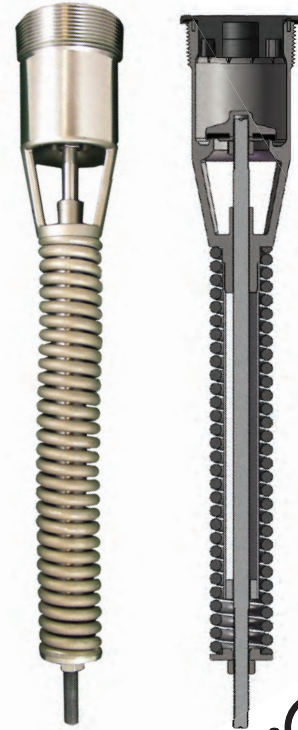

Travel stop prevents damage to relief valve seat

MEP200FIR/MEP300FIR  
Hex Installation Tool



Part No.	STD/ PSIG	Container Connection	Installation Hex	Flow Capacity SCFM/Air**	Service		Seat Material	Accessories	
				UL @ 120% Set Pressure	LPG	NH <sub>3</sub>		Cap	Hex Installation Tool
MEV200FIR/250	250	2"MNPT	1-1/2"	4,460	Yes	Yes	Nitrile	MEV200FIR-09	MEP200FIR
MEV200FIR/265	265	2"MNPT	1-1/2"	4,670	Yes	Yes	Nitrile	MEV200FIR-09	MEP200FIR
MEV200FIRV/250	250	2"MNPT	1-1/2"	4,460	Yes	No	Viton®	MEV200FIR-09	MEP200FIR
MEV200FIRV/265	265	2"MNPT	1-1/2"	4,670	Yes	No	Viton®	MEV200FIR-09	MEP200FIR
MEV200FIRK/250*	250	2"MNPT	1-1/2"	4,460	Yes	Yes	Kalrez® ~	MEV200FIR-09	MEP200FIR
MEV200FIRK/265*	265	2"MNPT	1-1/2"	4,670	Yes	Yes	Kalrez® ~	MEV200FIR-09	MEP200FIR
MEV300FIR/250	250	3" MNPT	2-1/2"	10,865	Yes	Yes	Nitrile	MEV300FIR-09	MEP300FIR
MEV300FIR/265	265	3" MNPT	2-1/2"	11,600	Yes	Yes	Nitrile	MEV300FIR-09	MEP300FIR
MEV300FIRV/250	250	3" MNPT	2-1/2"	10,865	Yes	No	Viton®	MEV300FIR-09	MEP300FIR
MEV300FIRV/265	265	3" MNPT	2-1/2"	11,600	Yes	No	Viton®	MEV300FIR-09	MEP300FIR
MEV300FIRK/250*	250	3" MNPT	2-1/2"	10,865	Yes	Yes	Kalrez® ~	MEV300FIR-09	MEP300FIR
MEV300FIRK/265*	265	3" MNPT	2-1/2"	11,600	Yes	Yes	Kalrez® ~	MEV300FIR-09	MEP300FIR

\* Seat Material not UL Listed  
 \*\* Flow rates are shown for bare relief valves, pipe-aways will reduce flow  
 \*\*\* Size relief capacity per NFPA 58 2011, table 5.7.2.6  
 ~ Recommended for LPG and NH<sub>3</sub> Dual Service Applications

Viton® and Kalrez® are trademarks of DuPont Performance Elastomers.



# FLANGED FULL INTERNAL PRESSURE RELIEF

Designed for use in mobile LPG & NH<sub>3</sub> containers as a primary pressure relief valve for bobtail and transport trailer installations. All working components are internal to the container connection preventing damage to the valve should a roll-over incident occur. Our unique design incorporates a standard 3"ANSI - 300LB. raised face flange connection to assure a 100% leak free connection for rugged over the road applications. This eliminates problems associated with NPT threaded connections and/or tank coupling wear due to vibration caused by over the road transit, providing maximum tank and relief valve service life.



MEV300FIR-3F c 

## FEATURES

- Durable single piece stainless steel flanged body construction.
- All stainless steel internal components for maximum corrosion resistance.
- Available with Nitrile, Viton®, or Kalrez® valve seals.
- Large seating surface for superior seal performance & reliability.
- Available with 250 & 265 PSI  LISTED set pressures.
- Custom set pressures available

Part No.	STD/ PSIG	Container Connection	Flow Capacity SCFM/Air**	Service		Seat Material	Accessories
			UL @ 120% Set Pressure	LPG	NH <sub>3</sub>		Cap
MEV300FIR-3F/250	250	3" 300LB. Flange	10,865	Yes	Yes	Nitrile	MEV300FIR-09
MEV300FIR-3F/265	265	3" 300LB. Flange	11,600	Yes	Yes	Nitrile	
MEV300FIRV-3F/250	250	3" 300LB. Flange	10,865	Yes	No	Viton®	
MEV300FIRV-3F/265	265	3" 300LB. Flange	11,600	Yes	No	Viton®	
MEV300FIRK-3F/250*	250	3" 300LB. Flange	10,865	Yes	Yes	Kalrez® ~	
MEV300FIRK-3F/265*	265	3" 300LB. Flange	11,600	Yes	Yes	Kalrez® ~	

\* Seat Material not UL Listed  
 \*\* Flow rates are shown for bare relief valves.  
 \*\*\* Size relief capacity per NFPA 58 2011, table 5.7.2.6  
 ~ Recommended for LPG and NH<sub>3</sub> Dual Service Applications

Viton® and Kalrez® are trademarks of DuPont Performance Elastomers.





# SEMI-INTERNAL PRESSURE RELIEF VALVES

Used as a pressure relief device on stationary ASME containers and domestic tanks

## FEATURES

- Durable all brass body
- Sturdy construction; made with non-corrosive internal materials
- Furnished with rain/dust cap for protection against contamination
- Rain cap also available separately
- Supplied with Everseal™ pre-applied thread sealant

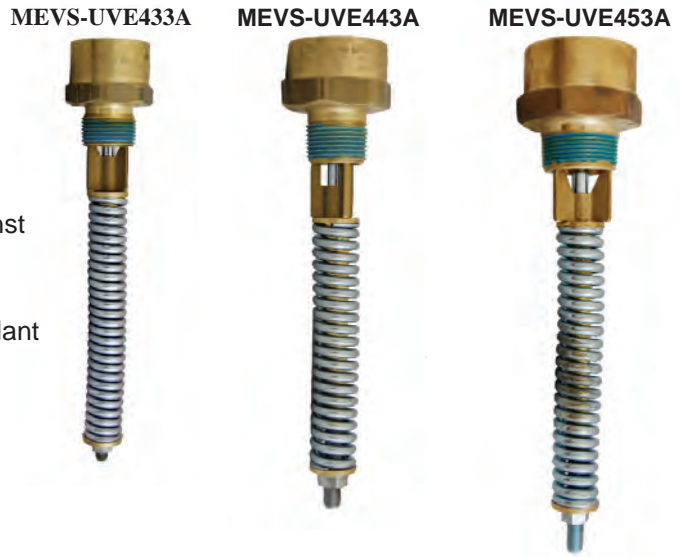

## MEPS-433-45A

Rain/Dust cap with lanyard to minimize cap loss



Protects against contamination

Part No.	STD Setting (PSIG)	Container Connection	Installation Hex	Flow Capacity SCFM/Air **	Tank Surface Area (Sq. Ft.)	Replacement Rain Cap
				UL @ 120% Set Pressure		
MEVS-UVE433AM/250	250	3/4" MNPT	1-1/16"	1,930	79	MEPS-433-45A
MEVS-UVE433AC/275*	275	3/4" MNPT	1-1/16"	1,709	68	MEPS-433-45A
MEVS-UVE443AM/250	250	1" MNPT	1-7/8"	2,755	122	MEPS-443-45A
MEVS-UVE443AC/275*	275	1" MNPT	1-7/8"	2,436	105	MEPS-443-45A
MEVS-UVE453AM/250	250	1-1/4" MNPT	2-7/16"	4,640	230	MEPS-453-45A
MEVS-UVE453AC/275*	275	1-1/4" MNPT	2-7/16"	4,406	216	MEPS-453-45A

\* California setting 275 psig  
 \*\* Flow rates are shown as bare relief valves  
 NOTE: Size relief capacity per NFPA58, table 5.7.2.6

# UNIVERSAL RELIEF VALVE COVERS

These covers are intended to protect both internal & external relief valves ranging in size from 1/2" to 1-1/4" NPT from moisture and/or other possible contaminants. Using the universal "shower cap" style relief valve covers will allow technicians to carry two sizes that will protect the majority of domestic tank relief valves.

## FEATURES

- Made with durable UV stable yellow vinyl material
- Fits 1/2" to 1-1/4" NPT internal and external relief valves



Part No.	Description	Material
MEH502	Adjustable Relief Valve Cover 1/2" to 3/4"	Yellow Vinyl
MEH503	Adjustable Relief Valve Cover 3/4" to 1-1/4"	Yellow Vinyl



# SEMI-INTERNAL PRESSURE RELIEF VALVES

Designed for use in large stationary LPG containers as a primary pressure relief valve. These pressure relief valves have been specifically designed to provide optimum performance when installed in either a 2" half or full coupling making them perfect for most large stationary tank installations.



MEV200SIR MEV200SSIR

**NOTE:** Available with all stainless steel components for NH<sub>3</sub> stationary container service applications.

## FEATURES

- Durable forged brass body with 3" NPT outlet pipeaway thread
- All steel & stainless steel stem, spring, and valve gasket holder for maximum corrosion resistance
- Available with Nitrile, Viton®, or Kalrez® valve seals
- Large seating surface for superior seal performance & reliability
- Available with 125, 250, 265 PSI  LISTED set pressures
- Custom set pressures available



Part No.	STD/ PSIG	Container Connection	Pipeaway Connection	Installation Hex	Flow Capacity SCFM/Air**	Service		Seat Material	Accessories
					UL @ 120% Set Pressure	LPG	NH <sub>3</sub>		
MEV200SIR/125	125	2"MNPT	3"MNPT	3-1/2"	4,870	Yes	No	Nitrile	MEV200SIR-106 (Cap & Lanyard)
MEV200SIR/250	250	2"MNPT	3"MNPT	3-1/2"	10,925	Yes	No	Nitrile	
MEV200SSIR/250	250	2"MNPT	3"MNPT	3-1/2"	10,925	Yes	Yes	Nitrile	
MEV200SIR/265	265	2"MNPT	3"MNPT	3-1/2"	11,475	Yes	No	Nitrile	
MEV200SSIR/265	265	2"MNPT	3"MNPT	3-1/2"	11,475	Yes	Yes	Nitrile	
MEV200SIRV/125	125	2"MNPT	3"MNPT	3-1/2"	4,870	Yes	No	Viton®	
MEV200SIRV/250	250	2"MNPT	3"MNPT	3-1/2"	10,925	Yes	No	Viton®	
MEV200SSIRV/250	250	2"MNPT	3"MNPT	3-1/2"	10,925	Yes	Yes	Viton®	
MEV200SIRV/250	250	2"MNPT	3"MNPT	3-1/2"	10,925	Yes	No	Viton®	
MEV200SSIRV/250	250	2"MNPT	3"MNPT	3-1/2"	10,925	Yes	Yes	Viton®	
MEV200SIRK/125*	125	2" MNPT	3"MNPT	3-1/2"	4,870	Yes	No	Kalrez®	
MEV200SIRK/250*	250	2" MNPT	3"MNPT	3-1/2"	10,925	Yes	No	Kalrez®	
MEV200SSIRK/250*	250	2" MNPT	3"MNPT	3-1/2"	10,925	Yes	Yes	Kalrez®	
MEV200SIRK/265*	265	2" MNPT	3"MNPT	3-1/2"	11,475	Yes	No	Kalrez®	
MEV200SSIRK/265*	265	2" MNPT	3"MNPT	3-1/2"	11,475	Yes	Yes	Kalrez®	

\* Seat Material not UL Listed

\*\* Flow rates are shown as bare relief valves.

\*\*\* Size relief capacity per NFPA 58 2011, table 5.7.2.6

Viton® and Kalrez® are trademarks of DuPont Performance Elastomers.



# HYDROSTATIC PRESSURE RELIEF VALVES

Designed to protect piping and shutoff valves from over pressure situations where liquid LP-Gas or NH<sub>3</sub> has the potential to be trapped. These relief valves provide pressure relief at or in excess of the stated pressure setting, protecting against line or plumbing system failures.

**NOTE:** NFPA #58 states, "Hydrostatic relief valves designed to relieve the hydrostatic pressure that can develop in sections of liquid piping between closed shutoff valves shall have pressure settings not less than 400 psig or more than 500 psig unless installed in systems designed to operate above 350 psig. Hydrostatic relief valves for use in systems designed to operate above 350 psig shall have settings not less than 110 percent or more than 125 percent of the system design pressure."

## FEATURES

- Compact design to fit any application
- Stainless steel spring
- Non-adjustable, tamper resistant design
- Stainless steel models rated for LP-Gas & NH<sub>3</sub>
- Specially designed internal components to increase flow at discharge



MEH225SS



MEH25



MEH50



MEH75

Part No.	Body Material	Seal Material	Start-to-Discharge Setting PSIG	Inlet MNPT	A	B	C	D	Accessory
									Pipeaway Adapter
MEH225	Brass	Nitrile	440	1/4"	1-1/16"	13/16"	1/4"	9/16" Hex	—
MEH225SS/350	Stainless Steel	Nitrile	350****	1/4"	1-1/16"	13/16"	1/4"	9/16" Hex	—
MEH225SS/400	Stainless Steel	Nitrile	400	1/4"	1-1/16"	13/16"	1/4"	9/16" Hex	—
MEH225SS	Stainless Steel	Nitrile	440	1/4"	1-1/16"	13/16"	1/4"	9/16" Hex	—
MEH25/450	Brass	Nitrile	450	1/4"	1-59/64"	1-43/64"	1/4"	7/8" Hex	MEP173*
MEH25K/450	Brass	Kalrez®	450	1/4"	1-59/64"	1-43/64"	1/4"	7/8" Hex	MEP173*
MEH25V/450	Brass	Viton®	450	1/4"	1-59/64"	1-43/64"	1/4"	7/8" Hex	MEP173*
MEH50/460	Brass	Nitrile	460	1/2"	2-1/2"	2-1/8"	3/8"	1-1/8" Hex	MEP174**
MEH75/460	Brass	Nitrile	460	3/4"	2-21/32"	2-5/32"	1/2"	1-1/8" Hex	MEP174**
MEJ602H***	Brass	Nitrile	440	1/4"	—	—	—	—	—

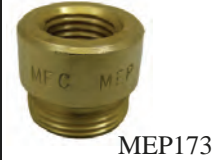
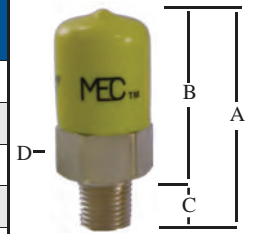

MEP173

\* 1/4" FNPT Outlet; \*\* 1/2" FNPT Outlet; \*\*\* Factory Installed Vent Valve, \*\*\*\* Special Applications  
 Viton® and Kalrez® are trademarks of DuPont Performance Elastomers.

# UNIVERSAL RELIEF VALVE COVERS

These protective caps are made of durable, fade resistant vinyl. All relief valves must have a protective cap to keep debris and water out of the valve.



MEH501

Part No.	Cap ID	Cap Height	Replacement Protective Cap for Part No.
MEH501-.437	.437"	3/8"	MEH225 MEH225SS Series
MEH501-.812	.812"	1"	MEH25/450
MEH501-1.062	1.062"	3/4"	MEH50/460 MEH75/460
MEH501-1.5	1.50"	1"	—

Part No.	Cap ID	Cap Height	Replacement Protective Cap for Part No.
MEH501-1.75	1.75"	1"	—
MEH501-2.25	2.25"	1"	—
MEH501-2.625	2.625"	1"	—
MEV250-013*	3.974	1/2"	MEV250 Series

\* With Lanyard



Made in the U.S.A.

# MULTI-PURPOSE VALVES

Intended for use as a high capacity filler valve with a manual shut-off device in LPG or NH<sub>3</sub> containers. These valves can be equipped with either a soft seat back check or excess flow feature that is internal to the container. The excess flow version can also be used as a vapor equalizing valve typically found in NH<sub>3</sub> applicators and nurse tank applications.

**NOTE:** For proper operation and performance of the excess flow feature the manual shutoff must be completely open and back seated.

## FEATURES

- Plated ductile iron body with 1/4" NPT auxillary plugged port
- All stainless steel internal construction for maximum corrosion resistance
- Supplied with ACME cap & chain assembly
- V-cup Teflon® packing stem seals
- Rated 400 PSI / WOG
- Removable data plate



ME670DBC



ME670DEX

MEC Multipurpose Filler / Withdrawal Valves								
Part No.	Inlet (MNPT)	Fill Connection (M. Acme)	*GPM/LPG Fill Capacity	Approximate Excess Flow Closing Flow		Back Check	Accessories	
				*Liquid GPM/LPG	**Vapor SCFH/LPG		Hydrostatic Relief	Vent Valve
ME670DBC	1-1/4"	1-3/4"	100	N/A	N/A	Yes	MEH225***	MEJ400***
							MEH225SS	MEJ402S
ME670DEX****	1-1/4"	1-3/4"	100	58	27,000	No	MEH225***	MEJ400***
							MEH225SS	MEJ402S

\* For NH<sub>3</sub> Flow Rates Multiply by .90  
 \*\* For NH<sub>3</sub> @ 100 PSI, Multiply by 1.6

\*\*\* Brass accessories cannot be used for NH<sub>3</sub>  
 \*\*\*\* Available for 45 GPM NH<sub>3</sub> closing flow - e.i. ME670DEX/45

The ME671DIBC is equipped with an integrated back check (IBC) feature built into the lower portion of the seat disc assembly. This feature allows liquid pressure built upstream of the shut-off disc assembly to automatically be relieved back to the container when line pressures exceed 10-25 PSI over container pressure. The (IBC) feature greatly reduces product emissions and increases overall system safety.

Part No.	Inlet (MNPT)	Withdrawal (FNPT)	Approximate Excess Flow Closing Flow Liquid GPM/LPG*	Integrated Back Check	Accessories	
					Hydrostatic Relief	Vent Valve
ME671DIBC-6	1-1/4"	3/4"	50	Yes	N/A	MEJ400**
					N/A	MEJ402S
ME671DIBC-8***	1-1/4"	1"	58	Yes	N/A	MEJ400**
					N/A	MEJ402S
ME671D-6	1-1/4"	3/4"	50	No	MEH225**	MEJ400**
					MEH225SS	MEJ402S
ME671D-8***	1-1/4"	1"	58	No	MEH225**	MEJ400**
					MEH225SS	MEJ402S
ME672D	1-1/4"	1"	78	No	MEH225**	MEJ400**
					MEH225SS	MEJ402S

\* For NH<sub>3</sub> Flow Rates Multiply by .90

\*\* Brass accessories cannot be used for NH<sub>3</sub> service

\*\*\* Available for 45 GPM NH<sub>3</sub> closing flow - e.i. ME671D-8/45



ME671D-8



ME672D



# MULTI-PURPOSE FILLER/WITHDRAWAL VALVES

Intended for use as a high capacity combination filler and liquid withdrawal valve with a manual shut off device in LPG or NH<sub>3</sub> containers. These valves can be equipped with either a soft seat back check or excess flow feature that is internal to the container. Ideally suited for use in dispensing applications as a dual purpose high capacity tank filler valve as well as a liquid return line from the pump bypass valve.

**NOTE:** For proper operation and performance of the excess flow feature the manual shutoff must be completely open and back seated.

## FEATURES

- Plated ductile iron body with 1/4" NPT auxillary plugged port
- All stainless steel internal construction for maximum corrosion resistance
- Supplied with ACME cap & chain assembly
- V-cup Teflon® packing stem seals
- Rated 400 PSI / WOG
- Removable data plate



Part No.	Inlet (MNPT)	Fill Connection (M. Acme)	Withdrawal (FNPT)	*Fill Capacity GPM/LPG	Approximate Excess Flow Closing Flow		Back Check	Accessories	
					*Liquid GPM/LPG	**Vapor SCFH/LPG		Hydrostatic Relief	Vent Valve
ME673DEX-6****	1-1/4"	1-3/4"	3/4"	100	58	27,000	No	MEH225***	MEJ400***
								MEH225SS	MEJ402S
ME673DEX-8****	1-1/4"	1-3/4"	1"	100	58	27,000	No	MEH225***	MEJ400***
								MEH225SS	MEJ402S
ME673DBC-6	1-1/4"	1-3/4"	3/4"	100	N/A	N/A	Yes	MEH225***	MEJ400***
								MEH225SS	MEJ402S
ME673DBC-8	1-1/4"	1-3/4"	1"	100	N/A	N/A	Yes	MEH225***	MEJ400***
								MEH225SS	MEJ402S

\* For NH<sub>3</sub> Flow Rates Multiply by .90      \*\*\* Brass accessories cannot be used for NH<sub>3</sub>  
 \*\* For NH<sub>3</sub> @ 100 PSI, Multiply by 1.6      \*\*\*\* Available for 45 GPM NH<sub>3</sub> closing flow - e.i. ME673DEX-6/4

# ASME TANK FILLER VALVES

Designed to allow maximum product transfer with its manually operated open throat design. These valves have an integral high flow primary soft-seat back check and a manually operated secondary shutoff valve for maximum protection against leaks. Because these valves provide a manually operated shutoff device, the need for a flow restricting fill check adapter has been eliminated.



Patent Pending



ME600-10

## FEATURES

- Allows **25-50%** more product flow during filling operations
- Manual valve portion assures operator when valve is open or closed
- Removable key provided to help prevent tampering
- Constructed with a durable Nitrile O-ring primary back check seal and reliable Teflon® packing for secondary manual valve seal
- Durable all brass construction for maximum weather and spark resistance

Part No.	Filler Valve MNPT	Hose End M. Acme Connection	Protective Cap Included	Additional Keys
ME600-6*	3/4"	1-3/4"	Yes	ME578-02
ME600-10*	1-1/4"	1-3/4"	Yes	ME578-02

\*Manual Shutoff



# DOUBLE CHECK FILL VALVES

Designed for DOT forklift, engine fuel and ASME residential tanks, these double check filler valves automatically open with pump pressure providing maximum product flow rates. Once flow ceases, both upper and lower check mechanisms close to prevent product loss from the container. The lower check serves as a secondary seat to limit product loss in the event that the primary upper seat fails to operate properly due to damage.

## FEATURES

- Industry best flow rate
- Resilient bonded main valve seal
- Integral break away feature leaves primary check intact in the event of delivery truck roll away
- Field repairable upper check seat
- Factory applied thread sealant

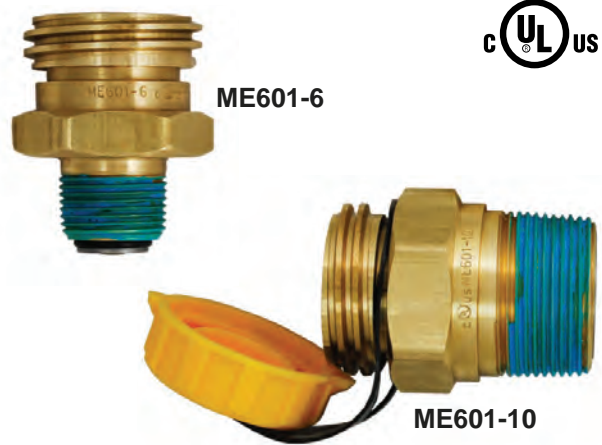

Part No.	Description	Flow Rate LPG		Accessories
		10 PSI	20 PSI	Cap & Lanyard
ME601-6	1-3/4" M. Acme x 3/4" MNPT Double Fill Valve w/ Cap & Lanyard	11	24	ME601-902
ME601-10	1-3/4" M. Acme x 1-1/4" MNPT Double Fill Valve w/ Cap & Lanyard	22	36	ME601-902

# VAPOR EQUALIZING VALVES

MEC vapor equalizing valves can be purchased in single or double check versions. The single check version can be used to facilitate pressure equalization of lines or containers but must not be installed directly into the container. A properly sized excess flow device must first be installed into container openings for compliance with NFPA Pamphlet #58. Double check versions consist of both an upper and lower check assembly. The upper check can be opened with vapor equalizing hose couplings equipped with projecting nozzle tips where the lower check is a normally open excess flow type. The lower excess flow check assembly automatically closes when flow out of the container exceeds its rated capacity. MEC double check vapor equalizing valves feature a two piece body construction where the upper check can be repaired while in service with minimal leakage from the container.

## FEATURES

- High flow construction
- Resilient bonded main valve seal
- Integral break away feature leaves primary check intact in the event of a line pull away
- Field repairable upper check seat

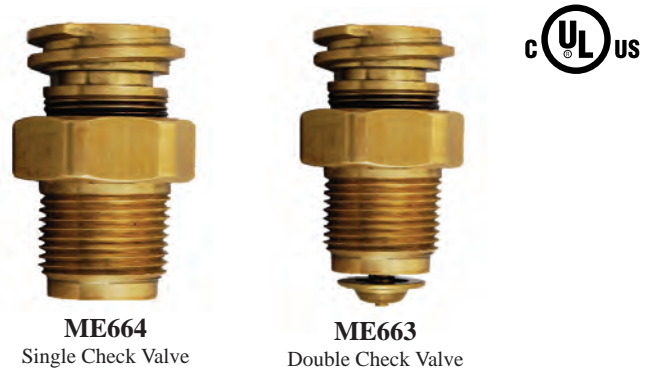

Part No.	Description	Closing Flow
ME663	Double Check Vapor Return Valve 3/4" MNPT x 1-1/4" M. ACME w/ Plastic Cap	4,000 SCFH/LPG
ME664	Single Check Vapor Return Valve 3/4" MNPT x 1-1/4" M. ACME w/ Plastic Cap	N/A



Intended for use in vapor withdrawal service for ASME and DOT containers or as fuel line shutoff valves.

**NOTE:** These valves do not incorporate an integral pressure relief valve and are intended for use in containers that have a separate stand alone pressure relief valve sized to properly handle the container's capacity.

**FEATURES**

- One piece forged brass body construction
- Dual O-ring packing design
- Easy to repair / replace bonnet assembly
- Universal bonnet assembly
- Industry best fill flow rate
- Factory applied thread sealant
- Heavy duty replaceable zinc hand wheel



Part No.	Description	Dip Tube Length
ME9101C1	3/4" MNPT X F. POL ASME/ DOT Service Valve (No Dip Tube)	N/A
ME9101D-11.1	3/4" MNPT X F. POL ASME/ DOT Service Valve (with Dip Tube)	11.1"
ME9101D-11.7	3/4" MNPT X F. POL ASME/ DOT Service Valve (with Dip Tube)	11.7"

## ASME TANK MANIFOLDING SERVICE VALVES

Intended for use in vapor withdrawal service for ASME tanks where more than one vessel is installed. The internal excess flow device at the inlet of the shutoff valve provides excess flow protection in the event of a downstream line break.

**NOTE:** These valves do not incorporate an integral pressure relief valve or double check fill valve and are intended for use in containers that have a stand-alone pressure relief valve sized to properly handle the container's capacity and a separate double check fill valve.

**FEATURES**

- One piece forged brass body construction
- Dual O-ring packing design
- Easy to repair / replace bonnet assembly
- Universal bonnet assembly
- Industry best fill flow rate
- Factory applied thread sealant
- Heavy duty replaceable zinc hand wheel
- ASME Compliant

Part No.	Description	Excess Flow GPM
ME9101C5	3/4" MNPT X F. POL ASME/ DOT Container Service Valve	2.6 GPM

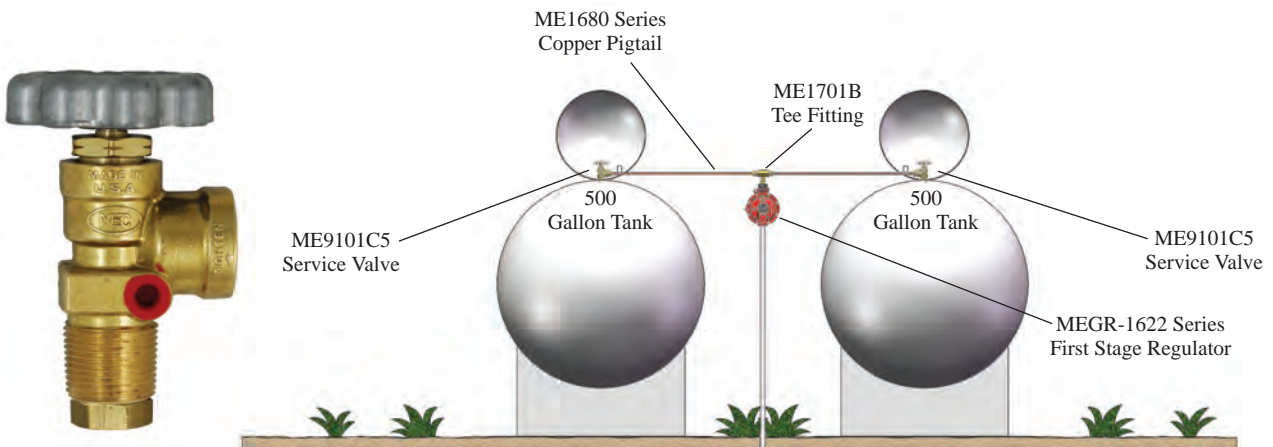

# MULTI-SERVICE VAPOR VALVES

## for ASME CYLINDERS

The **ME662 SERIES MULTI-SERVICE VALVE** is intended for use in vapor withdrawal service for ASME containers or as fuel line shutoff valves in combination with an integral double check fill and vapor equalization valve.

### FEATURES

- One piece forged brass body construction
- Dual o-ring packing design
- Easy to repair / replace bonnet assembly
- Universal bonnet assembly
- Heavy duty replaceable zinc hand wheel
- Plugged test port: ME662 Series - 1/4" FNPT  
ME665 Series - 1/8" FNPT
- SC model features optional self-cleaning LE thumb screw vent

**ME662**  
1-1/2" MNPT  
Multi-Service Valve



Part No.	Inlet	Outlet	Vent Type	Diptube Length
<b>ME662</b>	1-1/2" MNPT	F. POL	MEJ401	16.0"
<b>ME662SC</b>	1-1/2" MNPT	F. POL	MEJ401SC	16.0"



**ME665**  
3/4" MNPT Multi-Service Valve

The **ME665 SERIES MULTI-SERVICE VALVE** is intended for use in vapor withdrawal service for ASME containers or as fuel line shutoff valves in combination with an integral double check vapor equalization valve.

Part No.*	Inlet	Outlet	Vent Type	Diptube Length
<b>ME665</b>	3/4" MNPT	F. POL	MEJ401	12.0"
<b>ME665SC</b>	3/4" MNPT	F. POL	MEJ401SC	12.0"

**NOTE:** ME662 & ME665 series valves do not incorporate an integral pressure relief valve or double check fill valve and are intended for use in containers that have a stand-alone pressure relief valve sized to properly handle the container's capacity and a separate double check fill valve.



# VAPOR WITHDRAWAL VALVES

## for DOT 100 LB. CYLINDERS

Intended for use in vapor withdrawal service for DOT containers up to 100 lb. LPG capacity as fuel line shutoff valves in combination with a liquid fill and vapor relief valve.

**MES-PVE3250CLG-10.6**  
100 LB. Vapor Service Valve



### FEATURES

- One piece forged brass body construction
- Easy to repair / replace bonnet assembly
- Integral 375 PSI relief valve (Propylene service - 435 PSI)
- Heavy duty replaceable zinc hand wheel
- Optional MEJ401SC self-cleaning LE fixed liquid level vent screw
- F. POL vapor outlet with shutoff
- Available in vapor seal construction for propylene service
- Diptubes can be cut to length for specific tank needs

Part No.*	Descriptions	Container Type	Relief STD PSI	Vent Type	Diptube
MES-PVE3250BC-312	Service Vapor 3/4" NGT X F. POL (705 SCFM)	ASME	312	N/A	N/A
MES-PVE3250C-375	Service Vapor 3/4" NGT X F. POL	DOT	375	N/A	N/A
MES-PVE3250CV-435	Propylene Service Vapor 3/4" NGT X F. POL	DOT	435	N/A	N/A
MES-PVE3250CLG-375	Service Vapor 3/4" NGT X F. POL	DOT	375	MEJ401	N/A
MES-PVE3250CLGV-435	Propylene Service Vapor 3/4" NGT X F. POL	DOT	435	MEJ401	N/A
MES-PVE3250CLGSC-375	Service Vapor 3/4" NGT X F. POL	DOT	375	MEJ401SC	N/A
MES-PVE3250CLG-10.6	Service Vapor 3/4" NGT X F. POL	DOT	375	MEJ401	10.6"
MES-PVE3250CLGV-10.6	Propylene Service Vapor 3/4" NGT X F. POL	DOT	435	MEJ401	10.6"
MES-PVE3250CLGSC-10.6	Service Vapor 3/4" NGT X F. POL	DOT	375	MEJ401SC	10.6"
MES-PVE3250CLG-11.6	Service Vapor 3/4" NGT X F. POL	DOT	375	MEJ401	11.6"
MES-PVE3250CLGV-11.6	Propylene Service Vapor 3/4" NGT X F. POL	DOT	435	MEJ401	11.6"
MES-PVE3250CLGSC-11.6	Service Vapor 3/4" NGT X F. POL	DOT	375	MEJ401SC	11.6"



# LIQUID WITHDRAWAL VALVES

## for DOT 100LB. CYLINDERS

Intended for use in liquid withdrawal service for DOT containers up to 100 lb. LPG capacity as fuel line shutoff valves in combination with a liquid fill and vapor relief valve.

**MES-PVE3250CLG-106**  
100 LB. Vapor Service Valve



### FEATURES

- One piece forged brass body construction
- Easy to repair / replace bonnet assembly
- Integral 375 PSI relief valve
- Heavy duty replaceable zinc hand wheel
- Optional MEJ401SC self-cleaning LE fixed liquid level vent screw
- Male CGA555 liquid outlet with shutoff
- Integral 1.0 GPM/LPG excess flow valve

Part No.*	Descriptions	Container Type	Relief STD PSI	Withdrawal Tube Width	Vent Type	Diptube
MES-PVE3250CLM-375	Service Liquid 3/4" NGT X M. CGA555	DOT	375	1/4"	MEJ401	N/A
MES-PVE3250CLMSC-375	Service Liquid 3/4" NGT X M. CGA555	DOT	375	1/4"	MEJ401SC	N/A
MES-PVE3250CLM-11.6	Service Liquid 3/4" NGT X M. CGA555	DOT	375	1/4"	MEJ401	11.6"
MES-PVE3250CLMSC-11.6	Service Liquid 3/4" NGT X M. CGA555	DOT	375	1/4"	MEJ401SC	11.6"



# MULTI-SERVICE VAPOR VALVES

## for DOT 200LB. CYLINDERS

Intended for use in vapor withdrawal service for DOT containers up to 200 lb. LPG capacity as fuel line shutoff valves in combination with a fill and vapor relief valve. Ideal for on-site filling without interruption of service by combining all functions into a single 3/4" NPT tank opening.

### FEATURES

- One piece forged brass body construction
- Integral Fill Valve
- Easy to repair / replace bonnet assembly
- Integral 375 PSI relief valve
- Heavy duty replaceable zinc hand wheel
- Liquid splash tube to prevent liquid in vapor opening
- Optional MEJ401SC self-cleaning LE fixed liquid level vent screw
- F. POL vapor outlet with shutoff

MES-PVE2030BC Multi-Service Valve



Part No.*	Fill Connection	Inlet	Outlet	Vent Type	Diptube Length	Relief STD PSI
MES-PVE2030BC-10.6	1-3/4" ACME	3/4" NGT	F. POL w/ Shutoff	—	10.6"	375
MES-PVE2030BCSC-10.6	1-3/4" ACME	3/4" NGT		MEJ401SC	10.6"	375
MES-PVE2030BC-11.2	1-3/4" ACME	3/4" NGT		—	11.2"	375
MES-PVE2030BCSC-11.2	1-3/4" ACME	3/4" NGT		MEJ401SC	11.2"	375
MES-PVE2030BC-11.6	1-3/4" ACME	3/4" NGT		—	11.6"	375
MES-PVE2030BCSC-11.6	1-3/4" ACME	3/4" NGT		MEJ401SC	11.6"	375
MES-PVE2030BC-8.6	1-3/4" ACME	3/4" NGT		—	8.6"	375
MES-PVE2030BCSC-8.6	1-3/4" ACME	3/4" NGT		MEJ401SC	8.6"	375



# MULTI-SERVICE VAPOR VALVES

## for DOT/ASME 420LB. CYLINDERS

Intended for use in vapor withdrawal service for DOT or ASME containers ranging from 420 lbs. to 100 gallons LPG capacity as fuel line shutoff valves in combination with a fill and vapor relief valve. Ideal for on-site filling without interruption of service by combining all functions into a single 1" tank opening.

### FEATURES

- One piece forged brass body construction
- Integral Fill Valve
- Easy to repair / replace bonnet assembly
- Integral 375 PSI or 250 PSI relief valve
- Heavy duty replaceable zinc hand wheel
- 1/8" FNPT plugged test port
- Optional MEJ401SC self-cleaning LE fixed liquid level vent screw
- Liquid splash tube to prevent liquid in vapor opening
- F. POL vapor outlet with shutoff

MES-PVE2035AT Multi-Service Valve



Part No.*	Filler Connection	Inlet	Outlet	Diptube Length	Relief STD PSI	Vent Type
MES-PVE2035AT-11.2	1-3/4" ACME	1" NGT	F. POL	11.2"	375	—
MES-PVE2035ATSC-11.2	1-3/4" ACME	1" NGT	F. POL	11.2"	375	MEJ401SC
MES-PVE2035AT-11.7	1-3/4" ACME	1" NGT	F. POL	11.7"	375	—
MES-PVE2035ATSC-11.7	1-3/4" ACME	1" NGT	F. POL	11.7"	375	MEJ401SC
MES-PVE2035AT-250-11.2	1-3/4" ACME	1" NGT	F. POL	11.2"	250	—
MES-PVE2035ATSC-250-11.2	1-3/4" ACME	1" NGT	F. POL	11.2"	250	MEJ401SC
MES-PVE2035AT-250-11.7	1-3/4" ACME	1" NGT	F. POL	11.7"	250	—
MES-PVE2035ATSC-250-11.7	1-3/4" ACME	1" NGT	F. POL	11.7"	250	MEJ401SC
MES-PVE2035AT-250-12.0	1-3/4" ACME	1" NGT	F. POL	12.0"	250	—
MES-PVE2035ATSC-250-12.0	1-3/4" ACME	1" NGT	F. POL	12.0"	250	MEJ401SC

## DOT FORKLIFT CYLINDER & ENGINE FUEL VALVES

Intended for vapor or liquid withdrawal service on DOT forklift or engine fuel containers. Two closing flow rates are offered - 1.5 GPM for medium to light duty vehicles and 2.6 GPM for those with greater fuel demands.

**NOTE:** These valves **do not** incorporate an integral pressure relief valve and are intended for use in containers that have a separate pressure relief valve to adequately handle the container's capacity. Each of these valves incorporate an excess flow valve at the tanks inlet end to prevent excessive product loss in the event of a downstream fuel line failure. For the excess flow device to perform properly the service valve must be in the full open and back seated position.

### FEATURES

- One piece forged brass body construction
- Dual O-ring packing design
- Easy to repair / replace bonnet assembly
- Universal bonnet assembly
- Industry best fill flow rate
- Factory applied thread sealant
- Replaceable, heavy duty zinc hand wheel featuring a universal design

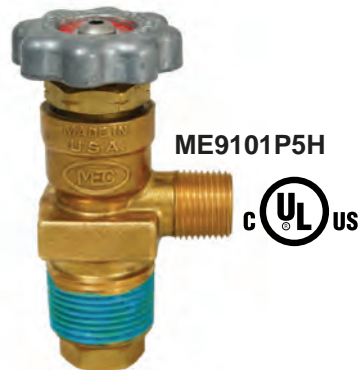

Part No.	Description	Excess Flow GPM
ME9101P5	3/4" MNPT X 3/8" MNPT Forklift Service Valve	1.6 GPM
ME9101P5H	3/4" MNPT X 3/8" MNPT Forklift Service Valve	2.6 GPM
ME9101H4	3/4" MNPT X 3/8" M. Flare Motor Fuel Service Valve	1.6 GPM
ME9101H6	3/4" MNPT X 3/8" M. Flare Motor Fuel Service Valve	2.6 GPM

This heavy duty designed wrench features a 1/2" drive socket extension for removing and installing motor fuel cylinder valves



## ENGINE FUEL REMOTE FILL VALVE

Specifically designed for remote filling applications where a standard tank type filler valve is not practical. Perfectly suited for motor fuel applications or other hard to reach remote tank applications. This single check fill valve is designed to provide maximum product fill rates along with an automatic shutoff once product flow ceases.

### FEATURES

- Single check design allows maximum product flow rate
- Integral break away feature leaves check valve intact in the event of a vehicle roll away during filling
- Resilient bonded main valve seal
- Rear bulkhead mounting with quarter panel jam nut and lock washer
- Single piece main valve body for maximum strength and durability



Part No.	Description	Accessories
		Cap & Lanyard
ME602-8	1-3/4" M. Acme x 1/2" M. Flare Remote Fill Valve w/ Cap & Lanyard	ME601-902



# UNDERGROUND TANK CLUSTER MANIFOLD

These multi-purpose valves are designed for use on domestic ASME underground tanks that require a single opening except for a separate opening for liquid withdrawal.



MES-PVE2098AT

## FEATURES

- Epoxy coated ductile iron manifold
- Durable o-ring service valve packing
- Easy to repair / replace bonnet
- Supplied with 30" diptube that can be cut to length
- Standard 1/4" NPT plugged gauge port
- Optional LE vent valve available

Part No.	Container Connection	Filling Connection	Service Connection Size	Closing Flow	Gauge Flange Opening	Pressure Relief Valve Setting	Relief Valve Capacity	Fixed Liquid Level Type
MES-PVE2098AT	2-1/2" FNPT	1-3/4" ACME	F. POL	4000 CFH @ 100 PSIG	Fits "Junior" Size	250 PSIG	1740 SCFM/air	MEJ400C
MES-PVE2098ATSC	2-1/2" FNPT	1-3/4" ACME	F. POL			250 PSIG		MEJ400SC
MES-PVE2098PT*	2-1/2" FNPT	1-3/4" ACME	F. POL	4000 CFH @ 100 PSIG	Fits "Junior" Size	250 PSIG	1740 SCFM/air	MEJ400C
MES-PVE2098PTSC*	2-1/2" FNPT	1-3/4" ACME	F. POL			250 PSIG		MEJ400SC

\* Includes ME460 Liquid withdrawal valve packed separately in carton.

# UNDERGROUND TANK CLUSTER VALVE REMOVAL TOOL

Universal design for convenient removal of underground tank cluster valves using a standard 3/4" drive socket wrench.

## FEATURES

- Durable cast steel construction
- Powder coat finish for maximum corrosion protection
- 3/4" drive

Part No.	Description
MEP126	Underground Tank Cluster Valve Removal Tool



MEP126



## ENGINE FUEL FILLER VALVES & CONNECTIONS

The CGA 790 quick closing couplings (ME220 Series) are designed to join the carburetion fuel line to the service valve on motor fuel type applications. The Acme threads allow for quick and repeated removal and connection with minimal product loss. The ME220M connects directly to the service valve outlet, while the ME220F Series connects to the motor fuel line. Both couplings have an internal safety check assembly that opens when the two are connected together. Spring force and pressure close both checks when disconnected to provide a leak free seal. The ME220M will fit any refill adapter on the market.

The ME790 Series is designed to provide a fast and reliable connection for filling motor fuel cylinders through the 1-1/4" male Acme service valve connector.

The Moto-Seal Low Emission Connector (ME220FSN) and Filler Valve (ME790SN) are the **industry's leader** in reducing product emissions without sacrificing flow emitting less than .3 CC during disconnect. The replaceable sealing tip allows the valve to make a bottom face seal when coupled with any mating motor fuel cylinder valve connector.

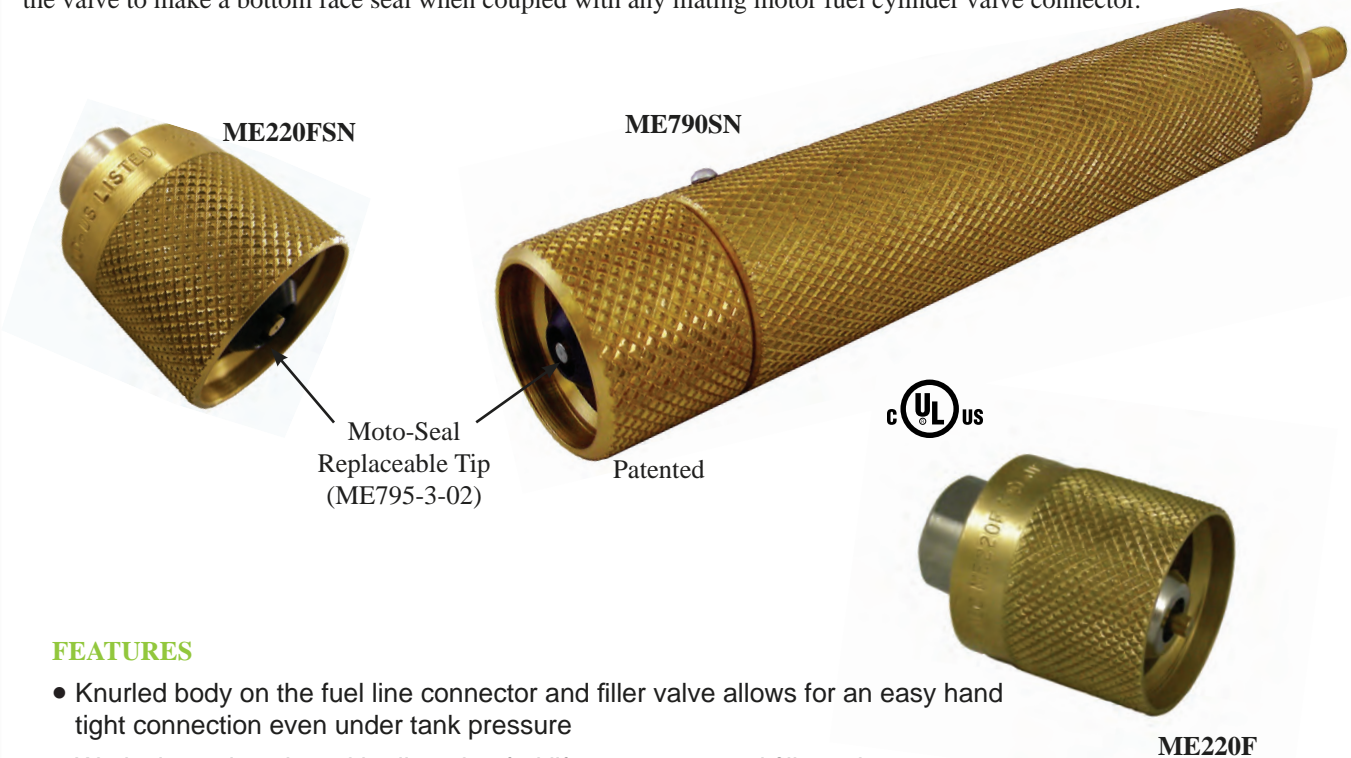

### FEATURES

- Knurled body on the fuel line connector and filler valve allows for an easy hand tight connection even under tank pressure
- Works in conjunction with all mating forklift connectors and filler valves
- ME220F series has a durable riveted valve stem, chrome plated body and wrench flats for easy installation
- ME220M has two seals—an O-ring to minimize product loss during connection and a gasket to seal the two connectors during filling operations
- Moto-Seal connector and filler offers
  - Replaceable tip for maximum service life
  - Positive seal every time with less than **.3 CC** product loss at disconnect
  - 3 layers of security against possible leaks or connection failures when the O-ring and flat gasket are intact on the male connector

Part No.	Moto-Seal Part No.	Inlet	Outlet	Application	Protective Brass Cap
ME220F	ME220FSN	1-1/4" Female Acme	1/4" FNPT	Fuel Line	—
ME220M	—	3/8" FNPT	1-1/4" Male Acme	Service Valve	ME220FP
ME790	ME790SN	1-1/4" Female Acme	1/4" MNPT	Filler Valve	—



Made in the  
U.S.A.

# VAPOR SERVICE ENGINE FUEL VALVES & CONNECTORS

These CGA 789 quick closing couplings are designed for use with vapor service motor fuel applications. Incorporates **all** the same features as the standard and Moto-Seal motor fuel filler valves and connectors. The left hand Acme thread allows service on outdoor motor fuel propane equipment including lawn mowers, etc.

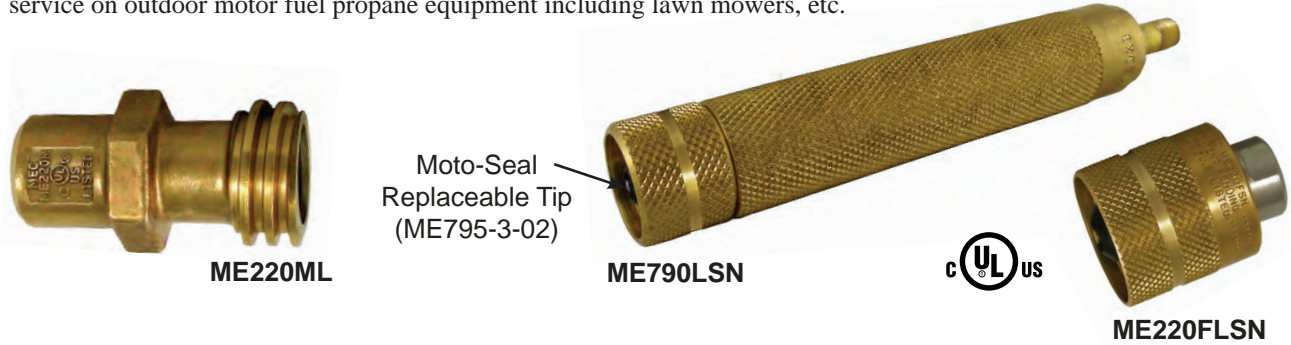

Part No.	Moto-Seal Part No.	Inlet	Outlet	Application	Protective Brass Cap
ME220FL	ME220FLSN	1-1/4" Female Left Hand Acme	1/4" FNPT	Fuel Line	—
ME220ML	—	3/8" FNPT	1-1/4" Male Left Hand Acme	Service Valve	ME220FLP
ME790L	ME790LSN	1-1/4" Female Left Hand Acme	1/4" MNPT	Filler Valve	—

# ENGINE FUEL BULKHEADS

These bulkheads provide a stationary point for motor fuel lines to pass thru sections of sheet metal.

Part No.	Connection	Connection
MET443	3/8" Male Flare	1/4" FNPT (2 Ports)
MET444	3/4"-16 Male / 1/4" FNPT	1/4" FNPT (2 Ports)
MET445	3/4"-16 Male / 1/4" FNPT	1/4" FNPT (3 Ports)



# CARBURATION FILTER & FITTINGS

The gas/air filter is used to filter foreign materials and/or particles from LP-Gas systems such as motor fuel/carburetion systems. Also designed to be used to filter air supply lines for internal and emergency shutoff valve actuator systems.

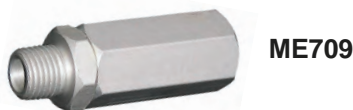

Enables the installation of a 1/4" MNPT hydrostatic relief valve in a safe, protected area. This two piece carburetion hose fitting fits all stainless steel braided LP-Gas hose with a 5/16" ID. The tank valve side has a 3/8" female flare swivel and zinc plated for maximum corrosion resistance.



Allows connection of a motor fuel service line from 1-3/4" female Acme vapor outlet.

Part No.	Inlet	Outlet	Side Port
ME709	1/4" FNPT	1/4" MNPT	—
ME229-EL	1-3/4" F. Acme	1/2" Male Flare	—
ME8346	5/16" ID	3/8" Female Flare	1/4" FNPT





## TYPE I (QCC) QUICK FILLER COUPLING

Designed to provide a fast, reliable connection for filling cylinders with Type I (QCC) style valves. The snap on/snap off design is intended to reduce labor and repetitive motion associated with threaded type filler couplings. This easy to operate filler coupling is durable, lightweight and will withstand the harshest working conditions while reducing cylinder valve thread wear.

**NOTE: A quick closing shutoff valve must be used with this coupling.**



### FEATURES

- Durable glass filled nylon handle
- Easy to use **snap on/snap off** action for quick fill operation
- All stainless steel internal components
- Large bore stainless steel stem for increased flow
- Right or left hand operation
- Universal filler connection for all Type I (QCC) service valves

Part No.	Inlet	Outlet
ME796	1/4" MNPT	1-5/16" Female Acme Quick Connect

## TYPE I (QCC) QUICK FILLER COUPLINGS & ADAPTERS

These full size Type I (QCC) filler couplings make filling DOT propane cylinders with a QCC connection quick and easy. Just a few turns allows the filler to attach and remove the coupling with minimal effort and loss of product. A longer body allows the filler coupling handle to remain outside the fixed collar of a cylinder. Can be used on a manual, electric or hydraulic system. In a manual system a shutoff valve (ME791C, ME791CJ, ME792C or ME792CJ) should be used with the filler coupling.

**WARNING:** It is illegal to fill a 40 pound or less DOT propane cylinder that has a standard POL connection.

Part No.	Inlet	Outlet	Handle Style	Body/Nipple Material	OAL
ME515	1/4" MNPT	1-5/16" Female Acme	Knurled	Brass/Brass	7"
ME516	1/4" MNPT	1-5/16" Female Acme	Heavy Duty Forged	Brass/Brass	6"
ME516S	1/4" MNPT	1-5/16" Female Acme	Heavy Duty Forged	Brass/Stainless Steel	6"

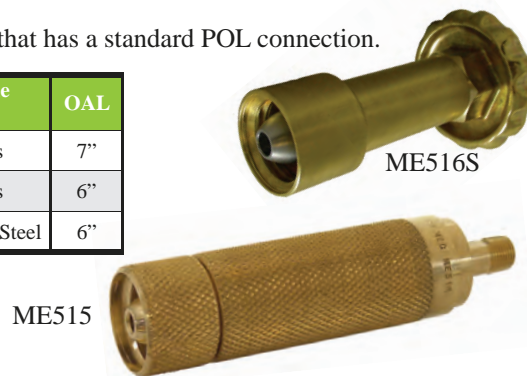

The Type I (QCC) thread replaces the POL connection on 40 pound or less DOT propane cylinders. Marshall Excelsior has developed numerous adapters to allow quick conversion from Type I (QCC) to different fill applications for retailers who fill both 40 pound or less and larger propane cylinders through the same line. Simply hand tighten the adapter to the Type I (QCC) filler coupling (ME515 or ME516 Series).

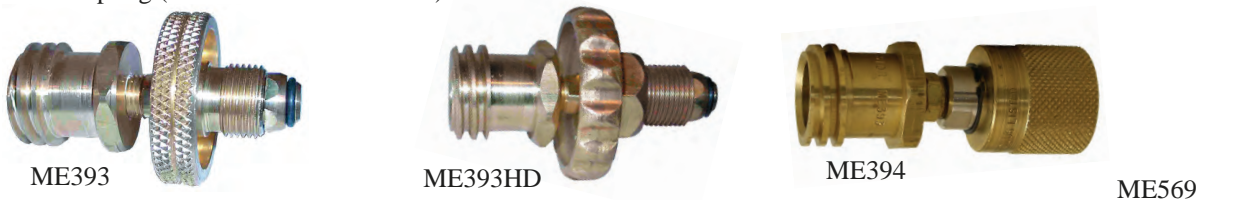

Part No.	Inlet	Outlet	Handle Style	Converts Type I (QCC) Filler Coupling to
ME393	1-5/16" Male Acme/Female POL	Male Soft Nose POL	Knurled	POL Filler Coupling
ME393HD	1-5/16" Male Acme/Female POL	Male Soft Nose POL	Heavy Duty Forged	POL Filler Coupling
ME394	1-5/16" Male Acme/Female POL	1-1/4" Female Acme	Knurled	Motor Fuel Filler Coupling
ME569	1-5/16" Male Acme/Female POL	1-3/4" Female Acme	Knurled	Tank Filler Coupling



# POL FILLER COUPLINGS & ADAPTERS

These POL filler couplings make filling DOT propane cylinders with a POL connection quick and easy. A few turns allow the soft nose POL to seal and unseal from the mating POL connection with minimal effort and loss of product. The long body models allow the filler coupling handle to remain outside the fixed collar of the cylinder. Can be used on manual, electric or hydraulic system. In a manual system a shutoff valve (ME791C, ME791CJ, ME792C or ME792CJ) should be used with the filler coupling.



ME390

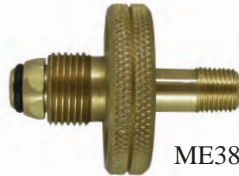

ME388



ME390S

Part No.	Inlet	Outlet	Handle Style	Body/Nipple Material	OAL
ME388	1/4" MNPT	Male Soft Nose POL	Knurled - 2" Dia.	Bass/Brass	2-11/16"
ME390	1/4" MNPT	Male Soft Nose POL	Heavy Duty Forged	Brass/Brass	6"
ME390S	1/4" MNPT	Male Soft Nose POL	Heavy Duty Forged	Brass/Stainless Steel	6"

These adapters allow for quick conversion from a POL connection to various filling applications for retailers who fill multiple cylinder types through the same Type I (QCC) connection. Simply hand tighten the adapter to the POL filler connection (ME388 or ME390 Series).

The ME393-2 allows for quick conversion from M. QCC (ME516) or F. POL (ME390) Fill Adapter to a Male Type II / Quick Fill Connector.

ME392



ME394



ME393-2



ME568



Part No.	Inlet	Outlet	Handle Style	Converts POL Filler Coupling to
ME392	Female POL	1-5/16" Female Acme	Knurled	Type I (QCC) Filler Coupling
ME393-2	Female POL	1-5/16" Male Acme	—	Male Type II / Quick Fill Connector
ME394	1-5/16" Male Acme/Female POL	1-1/4" Female Acme	Knurled	Motor Fuel Filler Coupling
ME568	Female POL	1-3/4" Female Acme	Knurled	Tank Filler Coupling

\* Replacement M. QCC/F. POL gasket - Part No. MEW3

# CYLINDER VALVE WRENCHES

Designed to remove or install Type I (QCC)/OPD cylinder valves or POL service valves without damage to the valve base.



MEP121

Part No.	Thread	Style
MEP121	Male POL	POL
MEP122	1-5/16" Female Acme	Type I (QCC)/ OPD



MEP122



## QUICK ACTING TOGGLE VALVES

Designed for use primarily on cylinder filling operations and industrial applications where quick and precise on/off operation is necessary. Note: This valve flows in one direction. Installing the valve in the opposite direction of the arrow may cause the valve to not close properly and/or pump pressure may open the valve.

### FEATURES

- Positive shutoff
- Corrosion resistant brass construction
- One hand operation
- Optional factory installed vent valve for safe release of captured product



ME791C



ME792C



ME791CJ



Part No.		Inlet	Outlet	Factory Installed Vent Valve
Non-Locking	Locking			
ME791C	ME792C	1/2" FNPT	1/4" FNPT	No
ME791CJ	ME792CJ	1/2" FNPT	1/4" FNPT	Yes
ME791D	ME792D	1/2" FNPT	1/2" FNPT	No
ME791DJ	ME792DJ	1/2" FNPT	1/2" FNPT	Yes

## LIQUID METHANOL INJECTOR

This gravity fed methanol injector provides a fast and efficient method to inject methanol into stationary ASME containers to help prevent condensation from freezing in the propane system.

**WARNING:** Never attempt to refill injector with methanol while connected to a propane container. In order for the tank and methanol injector vapor equalization to occur, no more than 42 ounces of methanol can be contained within the methanol injector.



MEP700

### FEATURES

- Spark resistant brass connectors and valve
- Durable steel construction body
- Automotive grade powder coat finish for maximum corrosion resistance
- For use with all multi-valve applications or where vapor recovery systems are in place

Maximum Capacity = 42 Ounces  
Maximum Pressure = 250 PSIG

Part No.	Vapor Connection	Description
MEP700	1-1/4" Female Acme	Assembly
MEP700-01	—	Body Only



# COPPER PIGTAILS & HOGTAILS

These pigtail and hogtail assemblies come with two brass connectors brazed onto a heavy wall annealed copper tube with a 250 psig pressure rating. The 1/4" and 3/8" tube have a pull test rating of 500 and 750 pounds respectively.  LISTED and tested in accordance with UL 569.

Different applications require specific pigtail and hogtail assemblies. Special attention is required when ordering to ensure the proper assembly is purchased for the intended application. Marshall Excelsior recommends every new installation or replacement regulator have a new pigtail installed.

**\*ME1600D Series Dielectric pigtails/ hogtails** are intended to isolate metallic piping from sources of electrical current and to help prevent galvanic corrosion when used on underground containers. The ME1600D dielectric pigtail/ hogtail would typically be installed at the ASME tank directly upstream of the first stage regulator prior to underground piping, isolating the underground metallic piping from electric current.

Description	Approx. Length	Part No.			
		1/4" Tube OD		3/8" Tube OD	
		Long Nipple	Short Nipple	Long Nipple	Short Nipple
Male Hard Nose POL x Male Hard Nose POL, 7/8" Nut	6	—	ME1664-06	ME1680L-06	ME1680-06
	12	ME1662-12*	ME1664-12*	ME1680L-12*	ME1680-12*
	20	ME1662-20*	ME1664-20*	ME1680L-20*	ME1680-20*
	30	ME1662-30	ME1664-30	ME1680L-30	ME1680-30
	36	ME1662-36	ME1664-36	ME1680L-36	ME1680-36
	48	ME1662-48	ME1664-48	ME1680L-48	ME1680-48
Male Hard Nose POL x Male Hard Nose POL, 1-1/8" Nut	20	ME1660-20	—	—	ME1680HD-20
	30	ME1660-30	—	—	—
	36	ME1660-36	—	—	—
	48	ME1660-48	—	—	—
1/4" Male Inverted Flare x Male Hard Nose POL, 7/8" Nut	15	—	ME1665-15	—	—
	20	ME1663-20	ME1665-20	—	—
	30	ME1663-30	ME1665-30	—	—
	36	ME1663-36	ME1665-36	—	—
	48	ME1663-48	ME1665-48	—	—
1/4" Male Inverted Flare x Male Hard Nose POL, 1-1/8" Nut	20	ME1661-20	—	—	—
	30	ME1661-30	—	—	—
	36	ME1661-36	—	—	—
	40	ME1661-40	—	—	—
	48	ME1661-48	—	—	—
1/4" MNPT x Male Hard Nose POL, 7/8" Nut	6	ME1679-06	ME1669-06	—	ME1689-06
	12	ME1679-12*	ME1669-12*	ME1689L-12	ME1689-12
	18	ME1679-18	ME1669-18*	—	—
	20	ME1679-20*	ME1669-20	ME1689L-20	ME1689-20
	30	ME1679-30	ME1669-30	ME1689L-30	ME1689-30
	36	ME1679-36	ME1669-36	—	ME1689-36
	48	ME1679-48	ME1669-48	—	ME1689-48
1/4" MNPT x Male Hard Nose POL, 1-1/8" Nut	20	ME1679HD-20	—	—	—
	48	ME1679HD-48	—	—	—
1/2" MNPT x Male Hard Nose POL, 7/8" Nut	12	—	—	ME1684L-12	ME1684-12
	20	—	—	ME1684L-20	ME1684-20



Long Nipple



Short Nipple



1/4" Inverted Flare



1/4" MNPT



Male Hard Nose POL, 7/8" Nut



Dielectric version



\* Note: Dielectric option available. Add "D" after the prefix part number i.e. ME1662D-12



# BENT COPPER PIGTAILS & HOGTAILS

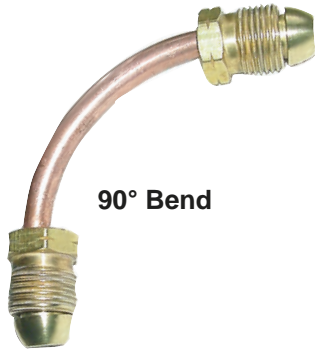

90° Bend



270° Bend Right Hand

Part No.	Approximate Length	1/4" Tube OD Short Nipple	3/8" Tube OD Short Nipple		
		90°	90°	270° Right	360°
Male Hard Nose POL x Male Hard Nose POL, 7/8" Nut	12	—	ME1680-12B90	ME1680-12B270R	ME1680-12B360
1/4" MNPT x Male Hard Nose POL, 7/8" Nut	5	ME1669-5B90	ME1689-5B90	—	—
	6	ME1669-6B90	ME1689-6B90	—	—

## THERMOPLASTIC HOSES - 3/8" HOSE ID

Flexible thermoplastic UL and CGA approved hose. These hoses are rated up to 350 psig working pressure with a 400 pound pull test rating. Each hose comes with two ends and fully crimped brass ferrules.

**WARNING:** An excess flow valve will not activate if there is a break or leak downstream of the valve that does not equal or exceed the closing flow of the valve or if the excess flow valve installed exceeds the flow capacity of the system. See the Excess Flow Warning page (PG. 18) for more information regarding the use of excess flow devices.



MNPT



3/8" Female Swivel

Part No. 3/8" Hose ID	Approximate Lengths "X"*	Connection	Connection
MER610-"X"	24, 30, 36, 48, 60, 120, 144, 240	3/8" MNPT	3/8" Female Flare Swivel
MER611-"X"	24, 30, 36, 40, 48, 60	1/2" Female Flare Swivel	3/8" MNPT
MER613-"X"	18, 24, 30, 36, 48, 60, 72, 120, 144, 180, 240, 300	3/8" Female Flare Swivel	3/8" Female Flare Swivel

\* Replace "X" with the desired hose length i.e. MER610-48



# THERMOPLASTIC HOSES - 1/4" HOSE ID

Part No. 1/4" Hose ID	Approximate Length "X"*	Connection	Connection
MER409-"X"	15, 20, 24, 36, 60	Male Hard Nose POL, 7/8" Nut	Male Hard Nose POL, 7/8" Nut
MER428-"X"	60, 120	Female QCC, Type I Connection	Male QCC, Type I Connection with Female POL
MER412-"X"	20	.9 GPM Excess Flow Male Hard Nose POL, 7/8" Nut	.9 GPM Excess Flow Male Hard Nose POL, 7/8" Nut
MER425-"X"	12, 15, 18, 20, 24, 30, 36, 48, 60	Female QCC, Type I Connection	1/4" Male Inverted Flare
MER427-"X"	20	Female QCC, Type I Connection	3/8" Female Flare Swivel
MER403-"X"	12, 15, 18, 20, 24, 30, 36, 48, 60, 72, 120, 240	Male Hard Nose POL, 7/8" Nut	1/4" Male Inverted Flare
MER401-"X"	12, 15, 18, 20, 24, 30, 36, 48, 60	.9 GPM Excess Flow Male POL, 7/8" Nut	1/4" Male Inverted Flare
MER423-"X"	15, 20, 24, 30, 36	.9 GPM Excess Flow Male Soft Nose POL, Plastic Handwheel	1/4" Male Inverted Flare
MER404-"X"	15, 18, 20, 24, 36	#60 Orifice Hole Male Soft Nose POL, Plastic Handwheel	1/4" Male Inverted Flare
MER404AR-"X"	18, 24, 36	#60 Orifice Hole Male Soft Nose POL, Brass Round Handwheel	1/4" Male Inverted Flare
MER406AR-"X"	12, 24, 36, 48, 60	Male Soft Nose POL, Brass Round Handwheel	1/4" MNPT
MER405-"X"	12, 15, 18, 20, 24, 30, 36, 48, 60	.9 GPM Excess Flow Male POL, 7/8" Nut	1/4" MNPT
MER414-"X"	10, 14, 120	1/4" MNPT	1/4" MNPT
MER422-"X"	6, 240	1/4" Female Flare Swivel	1/4" MNPT
MER434-"X"	36, 50	3/8" Female Flare Swivel	1/4" MNPT
MER429-"X"	72, 360	Red F. POL	Male QCC, Type I Connection with Female POL
MER426-"X"	15, 20, 60	Female QCC, Type I Connection	1/4" MNPT
MER410-"X"	10, 12, 20, 24, 30, 36, 48, 60, 72, 120, 144, 180	3/8" MNPT	3/8" Female Flare Swivel
MER413-"X"	24, 36, 48, 60, 72, 96, 120, 144, 180	3/8" Female Flare Swivel	3/8" Female Flare Swivel
MER408-"X"	12, 36, 60, 72, 144, 288	9/16"-18 Female Left Hand Swivel	9/16"-18 Female Left Hand Swivel
MER407-"X"	24, 36, 48, 60, 72, 120, 144	Male Soft Nose POL, Plastic Handwheel	1"-20 Male Swivel
MER421-"X"	24, 48, 60, 72, 144	1"-20 Female Swivel	1"-20 Male Swivel

\* Replace "X" with the desired hose length i.e. MER409-24



**PIGTAILS, HOGTAILS & HOSE ASSEMBLIES**



# High Flow THERMOPLASTIC HOSES - 1/4" HOSE ID

## for HIGH CAPACITY REGULATORS

The High Flow Series Hoses are specifically designed to meet the high demands of today's motorhomes, trailers and on demand water heaters.

Our new High Flow Type I 400,000 BTU (red nut) hoses are designed for those applications that require more than 200,000 BTU's. The new High Flow hoses are designed with both excess flow and thermal link safety features, just like the green nut Type I connector.

### FEATURES

- 400,000 BTU capacity
- Excess flow safety shut-off
- RVIA and NFPA 1192 Compliant
- Brass ferrules
- 1/4" ID High pressure thermoplastic hose
- 1/4" Inv. Flare and 1/4" MPT connection offered
- 100% Leak tested
- 350 PSIG working pressure



Part No.	Approximate Length "X" *	Connection	Connection	Available Packaged**
MER425H-"X"	12, 15, 18, 24	Female QCC, Type I Connection	1/4" Male Inverted Flare	Yes
MER426H-"X"	15, 20	Female QCC, Type I Connection	1/4" MNPT	Yes

\* Replace "X" with the desired hose length i.e. MER425H-15  
 \*\* Packaged option consists of a plastic clamshell with barcode: MER425H-15P

## STAINLESS STEEL BRAIDED HOSES

MEC Stainless Steel braided hoses are for connecting propane cylinders to the propane regulator. The Stainless Steel braid provides added protection to the hose along with the safety features of thermal protection in case of fire and excess flow protection in case of broken gas line. Female QCC, Type I connection x 1/4" inverted male flare.

**NOTE:** MEC green Type I Nut for use on RV application ONLY.

(200,000 BTU/H)

MEC red Type I NUT approved for RV applications.

(400,000 BTU/H)

### FEATURES

- Capacity: Standard - 200,000 BTU/H  
High Flow - 400,000 BTU/H
- Excess Flow Safety Shut-Off
- RVIA and NFPA 1192 Compliant
- Brass Ferrules
- 1/4" Inv. Flare and 1/4" MPT connection offered
- 100% Leak Tested
- 350 PSIG Working Pressure



Part No.	Approximate Length "X" *	Description
MER425SS-"X"	15, 24, 36	Standard QCC w/ Braided SS Hose
MER425HSS-"X"	15,24	High Capacity QCC w/ Braided SS Hose

\* Replace "X" with the desired hose length i.e. MER425SS-15



## FLOW-LONGER / FLOW-LONGER PLUS HOSE KITS

The **Flow-Longer** Propane Kits are designed to connect small, portable appliances, normally fueled by disposable LP-Gas cylinders, to the existing LP-Gas fuel supply of a recreational vehicle, cottage, backyard patio, etc. without interrupting the supply of regulated fuel to the system. **Flow-Longer** eliminates the need to purchase an extra LP-Gas cylinder or several small, disposable type cylinders.

### MER470 FLOW-LONGER PROPANE KIT INCLUDES

- Brass tee connection (ME415) .9 GPM excess flow male hard nose POL x female POL x 1"-20 male
- 12 foot hose (MER421-144) 1"-20 male x 1"-20 female

### MER471 FLOW-LONGER PLUS PROPANE KIT INCLUDES

- Brass elbow connection (ME423) .9 GPM excess flow male hard nose POL x 1-5/16" male Acme/female POL with quick closing poppet x 1"-20 female
- 12 foot hose (MER421-144) 1"-20 male x 1"-20 female



MER470



MER471

## STAY-LONGER / STAY-LONGER PLUS HOSE KITS

The **Stay-Longer** Propane Kits are designed to give you new flexibility on how you use your LP-Gas. You can stay longer by hooking up auxiliary LP-Gas cylinders, or you can tap into the RV's LP-Gas system to fuel portable high-pressure appliances.

### MER472 STAY-LONGER PROPANE KIT INCLUDES

- Brass tee connection (ME420) .9 GPM excess flow male hard nose POL x female POL x 1"-20 male x 1/4" female inverted flare
- 5 foot hose (MER401-60) .9 GPM excess flow male POL x 1/4" male inverted flare

### MER473 STAY-LONGER PLUS PROPANE KIT INCLUDES

- Brass tee connection (ME420) .9 GPM excess flow male hard nose POL x female POL x 1"-20 male x 1/4" female inverted flare
- 5 foot hose (MER401-60) .9 GPM excess flow male hard nose POL x 1/4" male inverted flare
- 12 foot hose (MER421-144) 1"-20 male x 1"-20 female



MER472



MER473

All kits include installation instructions and a convenient reusable box for storage.

**NOTE:** The tee fitting must be installed between the vapor withdrawal valve on your LP-Gas container and the pressure regulator. This properly places the tee fitting in the high pressure portion of the LP-Gas system. Gas connections to the tee fitting are not designed for movement or rotation after installation. Flexing, twisting, or vibration should be avoided.

**WARNING:** An excess flow valve will not activate if there is a break or leak downstream of the valve that does not equal or exceed the closing flow of the valve or if the excess flow valve installed exceeds the flow capacity of the system. See the Excess Flow Warning page for more information regarding the use of excess flow devices.



## TYPE I (QCC) / OPD VALVE CAP

Designed to protect the 1-5/16" male Acme threads on Type I (QCC) or OPD type cylinder valves. Using a cap will reduce the likelihood of inadvertent damage to the valve's threads, shutoff mechanisms and sealing surfaces during storage or refurbishment.

Part No.		Fits
Brass	Black Vinyl	
ME392P	ME952-07	1-5/16" Female Acme



## TYPE I (QCC) CONNECTORS

The Type I (QCC) connectors (ME517, ME518 and ME519 Series) are designed with a built-in excess flow feature and a positive shutoff that will not allow gas to flow until the connector is fully engaged. In case of a fire the built-in thermal protection on the QCC connector melts allowing the nipple to disengage from the tank connection and stop the flow of propane. These QCC connectors also provide a positive back check seal at disconnect to eliminate the propane in the hose from being released into the atmosphere.

To connect a Type I (QCC) connector to a cylinder, close the cylinder valve and the control valves to all connected appliances. Hand tighten the QCC onto the cylinder and slowly open the cylinder valve. If the valve is opened too quickly, the excess flow device will be activated closing the flow of propane to the appliance. If the excess flow device is activated, close appliance control valves and wait 60 seconds to allow pressure in the line to equalize. Additional equalization time may be needed depending on the length of the hose. Turn on appliances by following the manufacturer's suggested lighting procedures.

**NOTE:** The Type I (QCC) thread replaces the POL connection on 40 pound or less DOT propane cylinders.

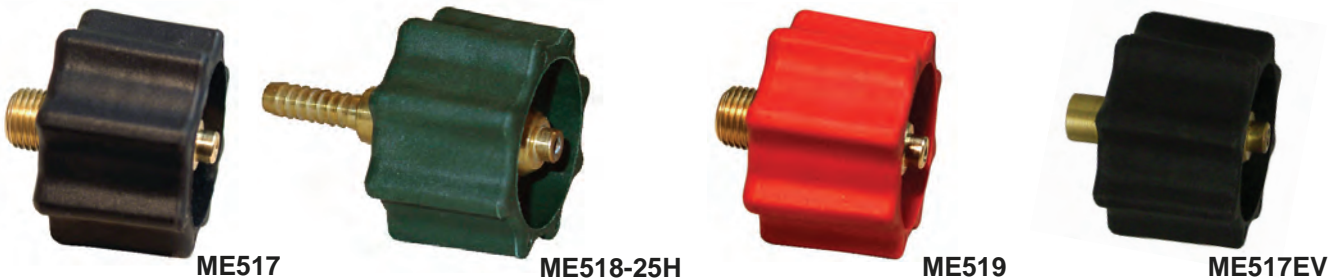

Part No.			Inlet	Flow Capacity	Handwheel Color	Thermal Protection
Outlet						
1/4" MNPT	1/4" Hose Barb	3/8" Hose Barb				
ME517	ME517-25H	ME517-38H	1-5/16" Female Acme	50 SCFH Air/100,000 BTUH	Black	Yes
ME518	ME518-25H	ME518-38H	1-5/16" Female Acme	100 SCFH Air/200,000 BTUH	Green	Yes
ME519	ME519-25H	ME519-38H	1-5/16" Female Acme	200 SCFH Air/400,000 BTUH	Red	Yes

Part No.	Inlet	Flow Capacity	Handwheel Color	Thermal Protection	Description
ME517EV	1-5/16" Female Acme	Full Flow	Black	Yes	Evacuation Coupling

**WARNING:** An excess flow valve will not activate if there is a break or leak downstream of the valve that does not equal or exceed the closing flow of the valve or if the excess flow valve installed exceeds the flow capacity of the system. See the Excess Flow Warning page for more information regarding the use of excess flow devices.



# GAS BOX™ CONVENIENCE OUTLET

Designed to **eliminate** the need for a 20 LB cylinder or modifications generally needed to plumb an outdoor appliance to a DOT or ASME stationary tank. The Gas Box™ utilizes the standard LP-Gas outdoor appliance regulator and connector. Simply hard plumb a gas line from the first stage regulator into the Gas Box™. Then thread the standard Type I (QCC) or POL connector onto the Gas Box™, turn on the shutoff valve and enjoy continuous LP-Gas flow. Both models provide full capacity operation at 10 psig or higher inlet pressures for all outdoor appliances without modifications.

The Gas Box™ is an easy way to guarantee **increased propane sales**. It eliminates the need for 20 pound cylinders, allowing the customer to purchase any appliance without modifications.

## FEATURES

- Universal Type I (QCC) / female POL outlet connection
- Primary shutoff valve for each outlet connection
- Secondary safety shutoff poppet at each outlet for zero discharge at disconnect
- For use with 10-250 psig inlet pressure
- Universal mounting hardware
- Hinged cover with latching mechanism
- Weather resistant high density polyethylene case

Part No.			Inlet	Outlet	No. of Outlets	Accessories
Color						
Black	Gray	Ivory				
ME951BLK	ME951GRY	ME951IVY	1/2" FNPT	1-5/16" Male Acme/Female POL	Single	MER428-60 = 60" Extension Hose MER428-120 = 120" Extension Hose (Male QCC/Female POL x Female QCC)
ME952BLK	ME952GRY	ME952IVY	1/2" FNPT	1-5/16" Male Acme/Female POL	Dual	MER429-60 = 60" Extension Hose MER429-120 = 120" Extension Hose (Male QCC/Female POL x Red Female QCC-400,000 BTU/H)



## FLOW RATE / CAPACITY SPECIFICATIONS

### Model ME951 – Single outlet \*

- 750,000 BTU/HR – 100 psig inlet pressure / Outlet regulated @ 9.5 – 13 in. W.C. (11" nom.)
- 450,000 BTU/HR – 10 psig inlet pressure / Outlet regulated @ 9.5 – 13 in. W.C. (11" nom.)

### Model ME952 – Dual outlet \*

One outlet closed

- 750,000 BTU/HR – 100 psig inlet pressure / Outlet regulated @ 9.5 – 13 in. W.C. (11" nom.)
- 450,000 BTU/HR – 10 psig inlet pressure / Outlet regulated @ 9.5 – 13 in. W.C. (11" nom.)

Both outlets open (at each outlet)

- 750,000 BTU/HR – 100 psig inlet pressure / Outlet regulated @ 9.5 – 13 in. W.C. (11" nom.)
- 325,000 BTU/HR – 10 psig inlet pressure / Outlet regulated @ 9.5 – 13 in. W.C. (11" nom.)

\*These are average capacities and may change slightly due to pressure drop depending on individual installation conditions and length of gas supply runs for the service line. The BTU capacities shown will be further reduced by the flow limiting device in the female type I connection provided with the appliance being attached to the gas box.



ME951BLK



ME952GRY



ME952IVY



MER428



# TYPE I (QCC) INSTALLATION ADAPTERS

Designed to provide a safe permanent outlet when installed into the household LP-Gas system. This permanent outlet eliminates the need for smaller containers when operating outdoor LP-Gas equipment. It is recommended that a shutoff valve be installed upstream from the adapter inlet to facilitate future servicing.

**NOTE:** To use the female POL on the ME393 series, simply remove the internal gasket. The gasket must be in place to use the Type I (QCC) connection.

### FEATURES

- Can be used with both Type I (QCC) and male POL connections
- ME398 and ME399 include an internal shutoff valve which provides a leak free means for outdoor equipment to be safely connected and disconnected without shutting down the entire system



ME399



ME393-1



ME398P



Part No.	Packaged Part No.	Inlet	Outlet	Shutoff Device
ME393-1	—	1/4" FNPT	1-5/16" Male Acme/Female POL	—
ME393EX	—	1/4" FNPT	1-5/16" Male Acme/Female POL	.9 GPM Excess Flow*
ME393EX1.8	—	1/4" FNPT	1-5/16" Male Acme/Female POL	1.8 GPM Excess Flow*
ME398	ME398P**	Male Soft Nose POL	1-5/16" Male Acme/Female POL	Quick Closing
ME399	—	1/4" MNPT	1-5/16" Male Acme/Female POL	Quick Closing

\* An excess flow device does not provide a 100% shutoff, a small amount of propane may leak if disconnected  
 \*\* Packaged option consists of a plastic clamshell

**WARNING:** An excess flow valve will not activate if there is a break or leak downstream of the valve that does not equal or exceed the closing flow of the valve or if the excess flow valve installed exceeds the flow capacity of the system. See the Excess Flow Warning page for more information regarding the use of excess flow devices.



# LOW PRESSURE QUICK DISCONNECT COUPLINGS

Designed to provide convenient quick connect and disconnect for low pressure gas appliances with 100% positive gas shut off at female coupler end of the connection. Maximum operating pressure 1/2 PSIG.

## FEATURES

- Convenient wrench flats for securing connection points
- One piece coupler body
- Approved for all low pressure gas applications
- Durable all brass construction
- For indoor & outdoor applications



ME-GMCL4



ME-GMC4



ME-GMC6

Part No.*	Description
ME-GMC4	Quick Disconnect Assy - 1/4" FNPT x 1/4" MNPT Nipple
ME-GMCL4	1/4" Quick Disconnect Ball Valve Coupler - 1/4" FNPT w/ Dust Cap
ME-GMC4-02	1/4" Quick Disconnect Nipple x 1/4" MNPT Adapter
ME-GMC4-03	1/4" Quick Disconnect Nipple x 1/4" Hose Barb Adapter
ME-GMC6	3/8" Quick Disconnect Assy - 3/8" FNPT Coupler x 3/8" FNPT Nipple
ME-RVSDC-4	Replacement Dust Cap - 1/4" QD Coupler w/ Lanyard



# CYLINDER COLLARS

These steel propane cylinder collars are designed to protect the valve installed on a cylinder. An automotive grade powder coat finish provides maximum corrosion resistance.

**WARNING:** It is illegal to fill a tank without a protective collar. Without a protective collar serious damage can occur to the cylinder valve which can lead to catastrophic events such as the tank becoming a dangerous projectile, an explosion and/or fire causing property damage, or personal injury or death.

Part No.	Size	*Multi-Valve
ME312-5MV	3-1/8"	Yes
ME350	3-1/2"	No
ME350MV	3-1/2"	Yes

\* Multi-Valve style features cut-out in thread to provide clearance for assembly over container valve



ME350



ME350MV



## MALE POL X 1/4" MNPT

Part No.			Connection	Male POL Description
Male Hard Nose POL	Male Hard Nose POL 90° Angle	Male Soft Nose POL		
ME318 ME318P*	ME345	ME1629	1/4" MNPT	7/8" Nut
ME322	—	—	1/4" MNPT	7/8" Nut, 3-1/2" OAL
—	—	ME1654	1/4" MNPT	Plastic Handwheel
—	—	ME1654AH	1/4" MNPT	Hex Handwheel
—	—	ME1654AR	1/4" MNPT	Round Handwheel
ME319	ME348	—	1/4" MNPT	1-1/8" Nut
ME1690 ME1690P*	—	ME1641	1/4" MNPT	.9 GPM Excess Flow, 7/8" Nut
—	—	ME1653	1/4" MNPT	.9 GPM Excess Flow, Plastic Handwheel
—	—	ME1653AH	1/4" MNPT	.9 GPM Excess Flow, Hex Handwheel
—	—	ME1653AR	1/4" MNPT	.9 GPM Excess Flow, Round Handwheel
ME1692	—	—	1/4" MNPT	.9 GPM Excess Flow, 1-1/8" Nut
ME1690-EX18	—	ME1641EX18	1/4" MNPT	1.8 GPM Excess Flow, 7/8" Nut
—	—	ME1638	1/4" MNPT	#60 Orifice Hole, 7/8" Nut

\* Packaged option consists of a plastic clamshell

Male Hard Nose POL



Male Soft Nose POL



Plastic Handwheel

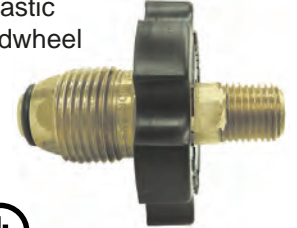

UL US  
ME345



## MALE POL X HOSE BARBS

Part No.		Hose I.D.	Male POL Description
Male Hard Nose POL	Male Soft Nose POL		
ME5930	ME1656-78N	1/4"	7/8" Nut
ME5931-78N	ME5931-78SN	3/8"	7/8" Nut
ME5930-118N	ME1656-118N	1/4"	1-1/8" Nut
ME5931	ME5931-SN	3/8"	1-1/8" Nut
—	ME1656	1/4"	Plastic Handwheel
—	ME1656AH	1/4"	Hex Handwheel
—	ME1656AR	1/4"	Round Handwheel
ME1683	ME1655-78N	1/4"	.9 GPM Excess Flow, 7/8" Nut
ME5931EX-78N	ME5931SNEX-78N	3/8"	.9 GPM Excess Flow, 7/8" Nut
ME1684	—	1/4"	.9 GPM Excess Flow, 1-1/8" Nut
—	ME1655	1/4"	.9 GPM Excess Flow, Plastic Handwheel
—	ME1655AH	1/4"	.9 GPM Excess Flow, Hex Handwheel
—	ME1655AR	1/4"	.9 GPM Excess Flow, Round Handwheel
—	ME1655EX18-78N	1/4"	1.8 GPM Excess Flow, 7/8" Nut
—	ME1657	1/4"	#60 Orifice Hole, 7/8" Nut

Hex Handwheel



Round Handwheel



**WARNING:** An excess flow valve will not activate if there is a break or leak downstream of the valve that does not equal or exceed the closing flow of the valve or if the excess flow valve installed exceeds the flow capacity of the system. See the Excess Flow Warning page for more information regarding the use of excess flow devices.



# SINGLE PIECE POL ADAPTERS

POL x MNPT			
Part No.	POL Connection	Excess Flow	MNPT
ME284	Female	—	1/4"
ME285	Female	—	3/8"
ME286	Female	—	1/2"
ME287	Female	—	3/4"
ME352	Male Hard Nose	—	3/8"
ME354	Male Hard Nose	—	1/2"
ME354EX9	Male Hard Nose	.9 GPM	1/2"
ME354EX18	Male Hard Nose	1.8 GPM	1/2"

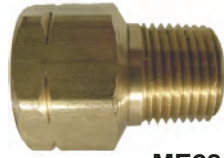

ME285



ME353EX18



ME353

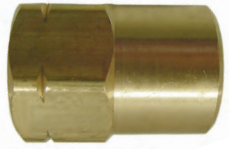

ME303

POL x Male Flare			
Part No.	POL Connection	Excess Flow	Male Flare
ME353	Male Hard Nose	—	3/8"
ME353-SN	Male Soft Nose	—	3/8"
ME353EX9	Male Hard Nose	.9 GPM	3/8"
ME353EX18	Male Hard Nose	1.8 GPM	3/8"
ME355	Male Hard Nose	—	1/2"
ME355-SN	Male Soft Nose	—	1/2"
ME355EX9	Male Hard Nose	.9 GPM	1/2"
ME355EX18	Male Hard Nose	1.8 GPM	1/2"
ME356	Male Hard Nose	—	5/8"
ME356-SN	Male Soft Nose	—	5/8"
ME356EX9	Male Hard Nose	.9 GPM	5/8"
ME356EX18	Male Hard Nose	1.8 GPM	5/8"

POL x FNPT		
Part No.	POL Connection	FNPT
ME300	Female	1/8"
ME301	Female	1/4"
ME302	Female	3/8"
ME303	Female	1/2"
ME304	Female	3/4"
ME351	Male Hard Nose	1/4"
ME357	Male Hard Nose	1/2"

POL x POL		
Part No.	POL Connection	POL Connection
ME305	Female	Female



**WARNING:** An excess flow valve will not activate if there is a break or leak downstream of the valve that does not equal or exceed the closing flow of the valve or if the excess flow valve installed exceeds the flow capacity of the system. See the Excess Flow Warning page for more information regarding the use of excess flow devices.

# POL CAP & PLUGS

Part No.			Style
Brass		Plastic	
Body Only	Body With Chain	Body Only	
ME1691	ME1691-1	ME970P	Male Hard Nose POL Plug
ME1699	—	—	Female POL Cap



ME1691



ME1699



ME970P



# SAFE-T-LOCKS

Designed to prevent tampering, product theft and/or accidental discharge of product. This product is perfect for any size tank valve with a POL connection or 1-3/4" Acme connection or gas plumbing, such as a riser.

To install, securely screw the plug or cap to the valving or plumbing using the appropriate wrench. Snap locking mechanism into place over plug or cap. Locking mechanism will cover the installation hex or knurl and swivel freely until key is inserted and the lock is removed.

### FEATURES

- All brass body construction for maximum durability
- Locking mechanism and key features durable chrome plating
- Locking mechanism swivels 360° when installed to prevent tampering or removal
- Locking mechanism cannot be removed without key
- Universal key for all sizes and styles

Part No.	Thread	Packaging	Additional Keys
ME530	Male Soft Nose POL	12 Plugs & Locks, 1 Key	ME530-03
ME531-50	1/2" FNPT	6 Caps & Locks, 1 Key	ME530-03
ME531-75	3/4" FNPT	6 Caps & Locks, 1 Key	ME530-03
ME532-38	3/8" Male Flare	12 Plugs & Locks, 1 Key	ME530-03
ME532-50	1/2" Male Flare	12 Plugs & Locks, 1 Key	ME530-03
ME533	1-3/4" Female Acme	2 Caps & Locks, 1 Key	ME530-03
ME530PL	Male Soft Nose POL	12 Caps & Locks, 1 Key	ME530-03



# POL THREAD CLEAN OUT TOOL

Designed for use with any female POL thread or valve inlet opening. Allows operator to safely remove debris and other foreign material from female .880-14 NGO left hand threads (female POL) without damaging threads. Simply thread clean out tool into female POL threads using handwheel until the tool reaches the final thread. Reverse and remove tool carefully. Reverse tool and use attached 7/8" diameter bottle brush to perform final clean out operation. Blow out any remaining debris by using a compressed air line.

### FEATURES

- Constructed from hardened tool steel and plated for maximum product life
- Four clearance flutes to allow debris to be channeled away from threads
- Convenient 7/8" diameter wire brush for final clean out



**WARNING:** The POL thread clean out tool is strictly intended for use as a cleaning device and in no way should be used as a gauge to determine the usability of the thread. (Always refer to NFPA 58 and follow the appropriate guidelines prior to installing LP-Gas lines)



# TEE CHECK MANIFOLDS

These manifolds are designed to connect two cylinders. The check keeps the two tanks equalized and allows each tank to be changed without disrupting the flow of propane to appliances or dispensing large amounts of LP-Gas into the atmosphere from the other tank. When changing out a tank, simply close the tank valve and disconnect. The check will automatically move to the closed tank valve side to seal off the inlet of that tank allowing minimal LP-Gas discharge into the atmosphere. Primary uses are for mobile homes, single appliances, recreational vehicles or summer cottages.

The manual changeover works the same as the check except it requires the consumer to manually close the manifold valve on the side of the tank being changed over.

Part No.	Packaged Part No.	Inlet	Inlet	Outlet	Nut Size
ME1701A	—	Female POL	Female POL	Male Hard Nose POL	7/8"
ME1702A	—	Female POL	Female POL	Male Hard Nose POL	1-1/8"
ME1705A	—	Female POL	Female POL	1/4" MNPT	—
ME1700A	ME1700A-P**	1/4" Female Inverted Flare	1/4" Female Inverted Flare	1/4" MNPT	—
MEP456A*	—	1/4" Female Inverted Flare	1/4" Female Inverted Flare	1/4" MNPT	—

\* Manual Change Over    \*\* Packaged option consists of a plastic clam shell



# MULTIPLE CYLINDER TEE BLOCK MANIFOLDS

These manifolds are designed to connect multiple cylinders to automatic changeover regulators. These manifolds have no check and are primarily for systems requiring more than one cylinder to be in operation at a time. The appropriate pigtail must be used to connect the manifold inlet to the service cylinder valve.

Part No.	Inlet	Inlet	Outlet	Nut Size
ME1701	Female POL	Female POL	1/4" FNPT	—
ME1701B	Female POL	Female POL	Male Hard Nose POL	7/8"
ME1702B	Female POL	Female POL	Male Hard Nose POL	1-1/8"
ME1701B-SN	Female POL	Female POL	Male Soft Nose POL	7/8"
ME1701X	Female POL	Female POL	Male .9 GPM Excess Flow Hard Nose POL	7/8"
ME1701B-X-SN	Female POL	Female POL	Male .9 GPM Excess Flow Soft Nose POL	7/8"
ME1704B	Female POL	Female POL	Female POL	1-1/8"
ME1700B	1/4" Female Inverted Flare	1/4" Female Inverted Flare	1/4" MNPT	—
ME-T9-444	1/4" FNPT	1/4" FNPT	1/4" MNPT	—

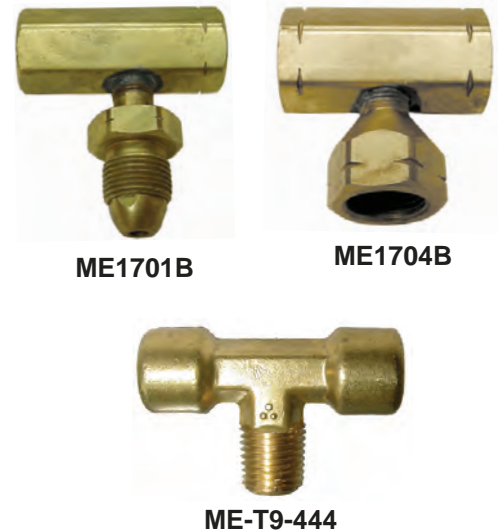

**WARNING:** An excess flow valve will not activate if there is a break or leak downstream of the valve that does not equal or exceed the closing flow of the valve or if the excess flow valve installed exceeds the flow capacity of the system. See the Excess Flow Warning page for more information regarding the use of excess flow devices.



# CAMPING TEES



Part No.	Packaged Part No.*	Inlet	Auxiliary Inlet	Outlet	Outlet
ME412	ME412P	1-5/16" Female Acme	—	1"-20 Male	1"-20 Male
ME413	ME413P	#60 Male Soft Nose POL with Round Brass Handwheel	—	1"-20 Male	1"-20 Male
ME414	ME414P	1"-20 Female	—	1"-20 Male	1"-20 Male
ME415	ME415P	.9 GPM Excess Flow Male Hard Nose POL	—	Female POL	1"-20 Male
ME416	—	.9 GPM Excess Flow Male Hard Nose POL with Plastic Handwheel	—	Female POL	Female POL
ME418	ME418P	1-5/16" Female Acme	—	1-5/16" Male Acme/Female POL with Quick Closing Poppet	1"-20 Male
ME420	ME420P	.9 GPM Excess Flow Male Hard Nose POL	1/4" Female Inverted Flare with Check	Female POL	1"-20 Male
ME421	—	.9 GPM Excess Flow Male Hard Nose POL	—	1-5/16" Male Acme/Female POL with Quick Closing Poppet	1"-20 Male
ME422	ME422P	1-5/16" Female Acme	1/4" Female Inverted Flare	1-5/16" Male Acme/Female POL with Quick Closing Poppet	1"-20 Male
ME424	—	.9 GPM Excess Flow Male Hard Nose POL	1/4" Female Inverted Flare with Check	1-5/16" Male Acme/Female POL with Quick Closing Poppet	1"-20 Male
ME425	ME425P	.9 GPM Excess Flow Male Soft Nose POL	1/4" Female Inverted Flare with Check	1-5/16" Male Acme/Female POL with Quick Closing Poppet	1"-20 Male

\* Packaged option consists of a plastic clamshell

**WARNING:** An excess flow valve will not activate if there is a break or leak downstream of the valve that does not equal or exceed the closing flow of the valve or if the excess flow valve installed exceeds the flow capacity of the system. See the Excess Flow Warning page for more information regarding the use of excess flow devices.



# CAMPING ELBOWS & ASSEMBLIES



ME423



ME481P



ME474



ME477



ME475AR



ME475



ME475B



ME497



ME497AR

Part No.	Packaged Part No.	Inlet	Outlet	Outlet
ME423	ME423P*	.9 GPM Excess Flow Male Hard Nose POL	1-5/16" Male Acme/Female POL with Quick Closing Poppet	1"-20 Male
ME474	—	1-5/6" Female Acme	1"-20 Male	—
ME475	ME475P*	#60 Male Soft Nose POL with Plastic Handwheel	1"-20 Male	—
ME475AR	—	#60 Male Soft Nose POL with Round Brass Handwheel	1"-20 Male	—
ME475B	—	#60 Male Soft Nose POL	1"-20 Male	—
ME477	—	.9 GPM Excess Flow Male Hard Nose POL with Plastic Handwheel	1"-20 Male	—
ME481	ME481P*	1"-20 Female	1-5/16" Male Acme/Female POL with Quick Closing Poppet	—
ME497	—	Male Soft Nose POL with Plastic Handwheel	1"-20 Male	—
ME497AR	—	Male Soft Nose POL with Round Brass Handwheel	1"-20 Male	—

\* Packaged option consists of a plastic clamshell

**WARNING:** An excess flow valve will not activate if there is a break or leak downstream of the valve that does not equal or exceed the closing flow of the valve or if the excess flow valve installed exceeds the flow capacity of the system. See the Excess Flow Warning page for more information regarding the use of excess flow devices.



# CAMPING FITTINGS



ME417



ME483



ME484



ME485



ME487



ME488



ME491



ME492



ME493  
with check and o-ring

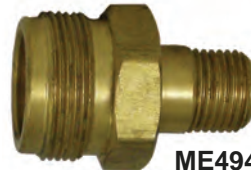

ME494  
no check

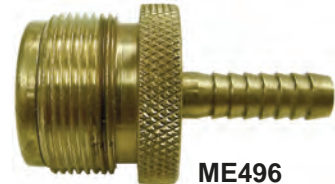

ME496

Part No.	Packaged Part No.	Inlet	Outlet
ME417	—	1/4" MNPT	1"-20 Male with Check & O-ring
ME483	—	1"-20 Female Cap with Strap	—
ME484	—	1"-20 Female	1/4" Hose Barb
ME485	—	1"-20 Female	1/4" FNPT
ME487	ME487P*	1"-20 Female	Female POL
ME488	ME488P*	1"-20 Female	1/4" MNPT
ME491	—	3/8" Male Flare	1"-20 Male with Check & O-ring
ME492	ME492P*	1/4" FNPT	1"-20 Male - No Check
ME493	—	9/16"-18 Male Left Hand	1"-20 Male with Check & O-ring
ME494	—	9/16"-18 Male Left Hand	1"-20 Male - No Check
ME496	—	1/4" Hose Barb	1"-20 Male Swivel with Valve Stem & O-ring

\* Packaged option consists of a plastic clamshell



ME487P



## LAST CHANCE ADAPTERS

Designed to provide a quick way to change from a 20 pound cylinder to a 1 pound disposable cylinder. Can be used to connect a small 1 pound disposable cylinder to a gas grill or other appliance.

**NOTE:** To use the male POL on the ME393 series, simply remove the internal gasket. The gasket must be in place to use the Type I (QCC) connection.



ME480EX



ME480



ME481P

Part No.	Packaged Part No.	Inlet	Outlet	Description
ME480	—	1"-20 Female	1-5/16" Male Acme/Female POL	Full Flow
ME480EX	—	1"-20 Female	1-5/16" Male Acme/Female POL	.9 GPM Excess Flow
ME480EX1.8	—	1"-20 Female	1-5/16" Male Acme/Female POL	1.8 GPM Excess Flow
ME481	ME481P**	1"-20 Female	1-5/16" Male Acme/Female POL	Shutoff Poppet

\* An excess flow device does not provide a 100% shutoff, a small amount of propane may leak if disconnected  
 \*\* Packaged option consists of a plastic clamshell

**WARNING:** An excess flow valve will not activate if there is a break or leak downstream of the valve that does not equal or exceed the closing flow of the valve or if the excess flow valve installed exceeds the flow capacity of the system. See the Excess Flow Warning page for more information regarding the use of excess flow devices.

## DIELECTRIC UNIONS

The ME690 series dielectric unions are intended to isolate metallic piping from sources of electrical current and to help prevent galvanic corrosion. The ME690 dielectric union would typically be installed at the ASME tank directly downstream of the first stage regulator but prior to underground piping and/or at the inlet of the second stage regulator above ground at the dwelling there by protecting the underground metallic piping from corrosion and electrical current.

### FEATURES

- Heavy duty brass construction
- Convenient male NPT x male SAE flare connection to minimize potential piping leak points and extra fittings
- Compact size for tight spaces
- Wide wrench flats for easy installation
- Will not conduct an electrical charge from one side of the union to the other



ME690-4-8

Part No.	Description	OAL
ME690-4-6	Dielectric Union 1/2" MNPT x 3/8" Male Flare	3-3/8"
ME690-6-6	Dielectric Union 3/4" MNPT x 3/8" Male Flare	3-1/2"
ME690-4-8	Dielectric Union 1/2" MNPT x 1/2" Male Flare	3-1/2"
ME690-6-8	Dielectric Union 3/4" MNPT x 1/2" Male Flare	3-5/8"
ME690-4-10	Dielectric Union 1/2" MNPT x 5/8" Male Flare	3-5/8"
ME690-6-10	Dielectric Union 3/4" MNPT x 5/8" Male Flare	3-3/4"



# FLARE FITTINGS



Short Forged Nuts	
Part No.	O.D. Tube Size
ME-NS4-4	1/4"
ME-NS4-6	3/8"
ME-NS4-8	1/2"
ME-NS4-10	5/8"
ME-NS4-12	3/4"



Reducing Forged Nuts	
Part No.	O.D. Tube Size
ME-NS4-6-4	3/8" x 1/4"
ME-NS4-8-4	1/2" x 1/4"
ME-NS4-8-6	1/2" X 3/8"
ME-NS4-10-8	5/8" X 1/2"



Forged Swivel Nuts	
Part No.	O.D. Tube Size
ME-US4-6	3/8"
ME-US4-8	1/2"
ME-US4-10	5/8"

Reducing Forged Swivel Nuts	
Part No.	O.D. Tube Size
ME-US4-8-6	1/2" x 3/8"
ME-US4-10-8	5/8" x 1/2"



Full Unions	
Part No.	O.D. Tube Size
MEF42-4-4	1/4"
MEF42-6-6	3/8"
MEF42-8-8	1/2"
MEF42-10-10	5/8"



Reducing Unions	
Part No.	O.D. Tube Size
MEF42-8-6	1/2" x 3/8"
MEF42-10-6	5/8" x 3/8"
MEF42-10-8	5/8" x 1/2"



Female Connectors		
Part No.	O.D. Tube Size	FNPT
MEF46-4-4	1/4"	1/4"
MEF46-6-4	3/8"	1/4"
MEF46-6-6	3/8"	3/8"
MEF46-6-8	3/8"	1/2"
MEF46-6-12	3/8"	3/4"
MEF46-8-6	1/2"	3/8"
MEF46-8-8	1/2"	1/2"
MEF46-8-12	1/2"	3/4"
MEF46-10-6	5/8"	3/8"
MEF46-10-8	5/8"	1/2"
MEF46-10-12	5/8"	3/4"



Male Connectors		
Part No.	O.D. Tube Size	MNPT
MEF48-4-2	1/4"	1/8"
MEF48-4-4	1/4"	1/4"
MEF48-6-2	3/8"	1/8"
MEF48-6-4	3/8"	1/4"
MEF48-6-6	3/8"	3/8"
MEF48-6-8	3/8"	1/2"
MEF48-6-12	3/8"	3/4"
MEF48-8-4	1/2"	1/4"
MEF48-8-6	1/2"	3/8"
MEF48-8-8	1/2"	1/2"
MEF48-8-12	1/2"	3/4"
MEF48-10-6	5/8"	3/8"
MEF48-10-8	5/8"	1/2"
MEF48-10-12	5/8"	3/4"
MEF48-12-8	3/4"	1/2"
MEF48-12-12	3/4"	3/4"



Forged Female Elbows		
Part No.	O.D. Tube Size	FNPT
MEF54-6-6	3/8"	3/8"
MEF54-6-8	3/8"	1/2"
MEF54-6-12	3/8"	3/4"
MEF54-8-6	1/2"	3/8"
MEF54-8-8	1/2"	1/2"
MEF54-8-12	1/2"	3/4"
MEF54-10-8	5/8"	1/2"
MEF54-10-12	5/8"	3/4"



Made in the U.S.A.

# FLARE FITTINGS & PIPE THREAD ADAPTERS



Forged Male Elbows		
Part No.	O.D. Tube Size	MNPT
MEF49-4-6	1/4"	3/8"
MEF49-6-4	3/8"	1/4"
MEF49-6-6	3/8"	3/8"
MEF49-6-8	3/8"	1/2"
MEF49-6-12	3/8"	3/4"
MEF49-8-4	1/2"	1/4"
MEF49-8-6	1/2"	3/8"
MEF49-8-8	1/2"	1/2"
MEF49-8-12	1/2"	3/4"
MEF49-10-8	5/8"	1/2"
MEF49-10-12	5/8"	3/4"



2 Way Forged Elbows	
Part No.	O.D. Tube Size
MEF55-6	3/8"
MEF55-8	1/2"
MEF55-10	5/8"
MEF55-12	3/4"



Male Tee	
Part No.	O.D. Tube Size
MEF44-6-6-6	3/8"
MEF44-8-8-8	1/2"
MEF44-10-10-10	5/8"

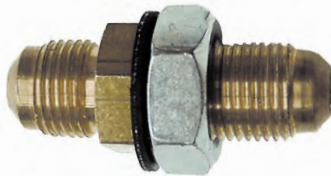

Flare Plugs	
Part No.	O.D. Tube Size
MEP2-4	1/4"
MEP2-6	3/8"
MEP2-8	1/2"
MEP2-12	3/4"

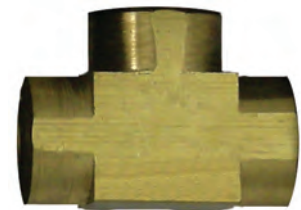

Female Tee	
Part No.	FNPT
ME415-01	1/4"

RV Bulkhead		
Part No.	Packaged Part No.	Description
MESTF33	MESTF33P	3/8" M. Flare x 3/8" M. Flare

\* Packaged option consists of a plastic clamshell



Flare Caps	
Part No.	O.D. Tube Size
ME1695-4	1/4"
ME1695-6	3/8"
ME1695-8	1/2"
ME1695-12	3/4"



Pipe Threads Unions		
Part No.	MNPT	MNPT
MEF216-2	1/8"	1/8"
MEF216-4	1/4"	1/4"
MEF216-6	3/8"	3/8"
MEF216-6-8	3/8"	1/2"
MEF216-8	1/2"	1/2"
MEF216-8-4	1/2"	1/4"
MEF216-12	3/4"	3/4"



Inverted Flare Adapter		
Part No.	Description	Accessory
ME2132	1/4" F. Inv. Flare x 1/4" MNPT	ME2131 1/4" Inverted Flare Plug



Tube Nut	
Part No.	O.D. Tube Size
MEF41-6	3/8"



# CGA 555 FITTINGS

CGA 555 adapters are standard cylinder valve outlet connections for liquid butane or propane withdrawal. They are designed to withstand pressures up to 3,000 psig.

Part No.	Inlet	Outlet
ME306	Female CGA 555	1/4" MNPT
ME307	Female CGA 555	9/16"-18 Male Left Hand
ME308	Female CGA 555	Female POL



ME306



ME308

Part No.	Cap with Chain
ME309-1	CGA 555



ME309-1

# HIGH PRESSURE GAS CONNECTIONS

Part No.			Hose I.D.	Threads
Hose Barb Assembly	Hose Barb Only	Nut Only		
ME23C	ME23C-1	ME23C-2	1/4"	9/16"-18 Female Left Hand
ME23E	ME23E-1	ME23C-2	3/8"	9/16"-18 Female Left Hand



ME23C

Part No.		Connection	POL Description
Male Hard Nose POL	Male Soft Nose POL		
ME1650	ME1650SN	9/16"-18 Male Left Hand	7/8" Nut
ME1651	—	9/16"-18 Male Left Hand	1-1/8" Nut
ME1689	ME1645-78N	9/16"-18 Male Left Hand	.9 GPM Excess Flow, 7/8" Nut
—	ME1645	9/16"-18 Male Left Hand	.9 GPM Excess Flow, Plastic Handwheel
ME1687	—	9/16"-18 Male Left Hand	.9 GPM Excess Flow, 1-1/8" Nut
ME1689-EX18	—	9/16"-18 Male Left Hand	1.8 GPM Excess Flow, 7/8" Nut

Soft Nose POL



Hard Nose POL



Outlet Bushings		
Part No.	Male Left Hand Thread	Thread
ME24C	9/16"-18	1/4" MNPT
ME24E	9/16"-18	3/8" MNPT
ME24F	9/16"-18	1/2" MNPT
ME26C	9/16"-18	9/16"-18 Male Left Hand



ME24C

**WARNING:** An excess flow valve will not activate if there is a break or leak downstream of the valve that does not equal or exceed the closing flow of the valve or if the excess flow valve installed exceeds the flow capacity of the system. See the Excess Flow Warning page for more information regarding the use of excess flow devices.



# HOSE BARBS

Part No.				Hose I.D.	Threads
Brass		Steel <sup>1</sup>			
Four Barb Low Pressure	Seven Barb High Pressure	Four Barb	Four Barb with 3/64" Orifice Hole		
ME4631	—	—	—	1/4"	1/8" FNPT
ME4632	ME5632	—	—	1/4"	1/4" FNPT
ME4633	ME5633	—	—	1/4"	3/8" FNPT
ME4652	—	—	—	3/8"	1/4" FNPT
ME4653	ME5653	—	—	3/8"	3/8" FNPT
ME4654	—	—	—	3/8"	1/2" FNPT
ME4231	ME5231	—	—	1/4"	1/8" MNPT
ME4232	ME5232	—	—	1/4"	1/4" MNPT
ME4233	ME5233	—	—	1/4"	3/8" MNPT
—	—	A6132	A6133	3/8"	1/8" MNPT
ME4252	—	A1132	A1133	3/8"	1/4" MNPT
ME4253	ME5253	—	—	3/8"	3/8" MNPT
ME4254	—	—	—	3/8"	1/2" MNPT
—	—	A6138	A6139	1/2"	1/8" MNPT
—	—	A1138	A1139	1/2"	1/4" MNPT
ME4273	—	—	—	1/2"	3/8" MNPT
ME4274	ME5274	—	—	1/2"	1/2" MNPT
ME4293	—	—	—	5/8"	3/8" MNPT
ME4835	ME5835	—	—	1/4"	3/8" Male Flare
ME4855	—	—	—	3/8"	3/8" Male Flare
ME4857	—	—	—	3/8"	1/2" Male Flare
—	ME5133	—	—	1/4"	1/4" Male Inverted Flare
ME4333	—	—	—	1/4"	1/4" Female Flare Swivel
ME4335 <sup>2</sup>	ME5334 <sup>5,6</sup> ME5335	—	—	1/4"	3/8" Female Flare Swivel
ME4355 <sup>3</sup>	ME5336 <sup>6</sup> ME5355	—	—	3/8"	3/8" Female Flare Swivel
ME4357	ME5357	—	—	3/8"	1/2" Female Flare Swivel
ME4377 <sup>4</sup>	ME5377	—	—	1/2"	1/2" Female Flare Swivel

1—Rated for LP-Gas & NH<sub>3</sub>      4—ME4377-1 (barb only); ME4377-2 (nut only)  
 2—ME4335-1 (barb only); ME4335-2 (nut only)    5—ME5334-1 (barb only)  
 3—ME4355-1 (barb only); ME4355-2 (nut only)    6—Forged Nut



ME4652



ME5632



ME5233



ME4252



A1132



ME4835



ME5133



ME5335





# HOSE FERRULES & HOSE MENDERS



ME7327



ME27C



ME27E

Part No.	I.D.	OAL
ME7323	.525"	1"
ME7324	.531"	1"
ME7325	.562"	1"
ME7326	.593"	1"
ME7327	.625"	1"

Part No.	I.D.	OAL
ME7329	.687"	1"
ME7330	.718"	1"
ME7331	.750"	1"
ME7332	.781"	1"
ME7333	.812"	1"

Part No.	Hose I.D.
ME27C	1/4" x 1/4"
ME27E	3/8" x 3/8"

## LOW TEMPERATURE LEAK DETECTOR

General purpose leak detector for all pressurized gases. Designed to detect joint leaks within 5 seconds of proper application at temperatures down to -40° F.

Part No.	Size	Description
ME-LD02	2 Ounces	Spray Bottle
ME-LD1	8 Ounces	Cap and Dauber
ME-LD16	16 Ounces	Cap and Brush
ME-LD2	1 Gallon	Container



ME-LD02



ME-LD16



ME-LD2

## HIGH PRESSURE TEST BLOCKS

Designed to test high pressure lines downstream of the container valve for system leaks. The optional bleeder valve enables the line pressure to be adjusted to the desired test pressure.

Part No.	Inlet	Outlet	PSIG	Factory Installed Vent Valve
MEJ600	Male Hard Nose POL	Female POL	0-300	No
MEJ601	Male Hard Nose POL	Female POL	0-300	Yes
MEJ601-WOG*	Male Hard Nose POL	Female POL	—	Yes

\* Without gauge

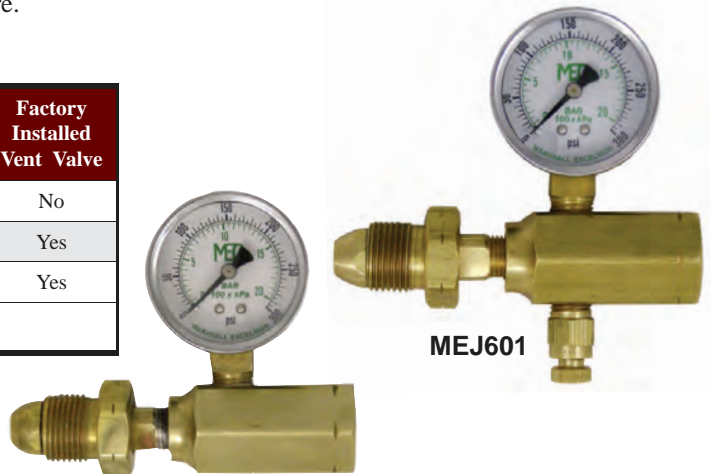

MEJ600

MEJ601



# LOW PRESSURE TEST KIT & ADAPTERS

These kits are designed to check for gas leaks by verifying the line pressure of an appliance. Each kit includes a case, gauge, and rubber hose with a bell on the end.

## FEATURES

- Capacity 0 - 35" water column
- Adjustable gauge models can be reset to zero with provided screwdriver
- Three foot rubber hose with bell



ME50-2



ME50P-5



ME60P-2



ME50P-2

Kit with Case	Part No.			Adjustable Gauge	Manometer Adapter
	Gauge & Hose Only	Gauge & Hose Barb Connection	Gauge & 1/4" MNPT Connection		
ME60P-2	ME60P-5	—	ME60-2	Yes	ME1328 (3/8" OD) ME1331 (1/2" OD)
ME50P-2	ME50P-5	ME50-2	ME50-2-01	No	ME1332 (5/8" OD)



ME1332

## SERVICEMAN'S FRIEND

The serviceman's friend (METL051 & METL052) eliminates the hassle of carrying numerous bushing and fittings to each job site. It has three threads on one end with a hose barb and an 1/8" MNPT on the other end. A hose can easily be attached to either end and can be connected to a manometer or other flow meters to check line pressure on an appliance.

Part No.	Connection	Connection
METL051	5/16"-32 Male / 1/8" MNPT / 1/2" MNPT	Standard test hose fitting/1/8" MNPT
METL052	5/16"-32 Male / 1/8" MNPT / 1/4" MNPT	Standard test hose fitting/1/8" MNPT



METL051

## LOW PRESSURE TEST BLOCK



MEJ610/30

Designed to test low pressure lines for system leaks. The factory installed check valve allows the line to be pressurized and adjusted to the desired test pressure.

Part No.	Inlet	PSIG
MEJ610/15	3/4" FNPT	0-15
MEJ610/30	3/4" FNPT	0-30
MEJ610/60	3/4" FNPT	0-60
MEJ610/100	3/4" FNPT	0-100



# PRESSURE TEST ACCESSORIES

These accessories are easily adaptable to industry standard pressure test equipment and provide a very reliable, inexpensive, permanent way to test both high and low pressure lines in domestic tank installations.

## FEATURES

- Reliable method to test high and low pressure tap installations
- Provides an effective method to bleed vapor for pressure equalization and more accurate gauge readings
- Allows for an effective method to bleed vapor from the testing equipment prior to disconnect
- High quality liquid filled pressure gauge



**MEJ603HP**

Part No.	Outlet	Inlet	PSIG	Factory Installed Vent Valve
MEJ602*	1/4" FNPT	1/4" MNPT	—	Yes
MEJ603LP	1/4" FNPT	1/4" MNPT	0-15	Yes
MEJ603HP	1/4" FNPT	1/4" MNPT	0-300	Yes

\* Without gauge

These accessories are intended for first stage regulators with pressure taps in either the upstream or downstream positions.

Part No.	Connection	Connection	Approx. Length
1/4" Hose ID			
MER432-6	1/8" MNPT	1/4" FNPT	6"
MER432-12	1/8" MNPT	1/4" FNPT	12"



**MER432 Series**

Designed to provide an inexpensive way to permanently install a pressure tap upstream or downstream from the first stage regulator. The #54 orifice port provides controlled line pressure for more accurate readings and protects test equipment from pressure spikes while allowing easy installation of pressure test monitoring devices.

Part No.		Connection	Connection	Port Hole with #54 Orifice
With Plug	Without Plug			
ME295	ME295-1	Male Hard Nose POL	Female POL	1/8" FNPT
ME295SN	ME295SN-1	Male Soft Nose POL	Female POL	1/8" FNPT
ME296	ME296-1	1/4" MNPT	1/4" FNPT	1/8" FNPT
ME297	ME297-1	3/8" MNPT	3/8" FNPT	1/8" FNPT
ME298	ME298-1	1/2" MNPT	1/2" FNPT	1/8" FNPT
—	MEJ595	1/2" MNPT	1/2" FNPT	1/4" FNPT with no Orifice
ME299	ME299-1	3/4" MNPT	3/4" FNPT	1/8" FNPT

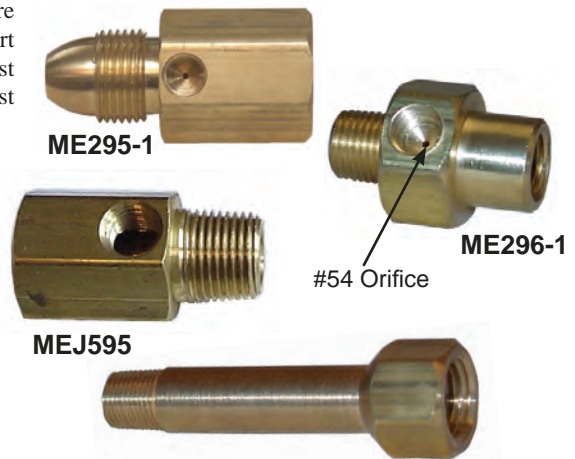

Part No.	Connection	Connection	Description
MEJ604	1/4" FNPT	1/8" MNPT	Extension



This check valve allows the line to be pressurized and adjusted to the desired pressure through the same valve.

Part No.	Connection	Connection	Thread Sealant
MEJ607-02	1/4" MNPT	5/16"-32 Male	No
MEJ608-02	1/8" MNPT	5/16"-32 Male	No
MEJ608B-02	1/8" MNPT	5/16"-32 Male	Yes

**NOTE:** To help eliminate valve failure, the valve cap should remain on the valve when line is not be pressurized or adjusted. Any dirt, debris, water or other contaminants can potentially jam the valve or compromise the sealing surface causing the valve to leak.



Part No.	Connection	Connection
ME10BTK-1-01	1/8" FNPT	5/16"-32 Female



# Flex-Vent™ REGULATOR KIT

The MEC Flex-Vent™ provides a safe and easy solution to vent LP Gas regulators away from open sources of ignition or other potential fire hazards. Meets all requirements of the new flexible material allowance in the 2011 NFPA-58, section 5.8.3.1 (3).



**ME960 Series**

### FEATURES

- Durable, UV stable flexible PVC hose material suitable for use with LP Gas vapor
- 3/4" NPT swivel inlet for easy installation
- Standard 90° vent assembly with screen
- Mounting clamps and coated masonry screws supplied
- Crimped ends for maximum durability
- Available in 3, 4, 6 & 10 ft. lengths\*



**ME900-6**

Part No.	Description	Accessories
ME960-36	MEC Flex-Vent Kit - Fixed Ends - 3 ft.	90° Regulator Vent Assembly ME900-6
ME960-48	MEC Flex-Vent Kit - Fixed Ends - 4 ft.	
ME960-72	MEC Flex-Vent Kit - Fixed Ends - 6 ft.	
ME960-120	MEC Flex-Vent Kit - Universal Outlet (not crimped) - 10 ft.	
ME960-120C	MEC Flex-Vent Kit - Universal Outlet (crimped) - 10 ft.	

\* Custom lengths available upon request

## LED 12V LIGHT STRIP

Universal LED Light Strip can be installed anywhere to provide extra lighting right where you need it.

### FEATURES

- Bright White LED
- Pre-Applied 3M Adhesive backing for easy installation
- Can be cut to any length

Part No.	Description
MEP104-95	LED Light Strip



	Part No.	Description
<b>Acme Adapters</b>	ME251-02	3-1/4" Acme Screen
	ME251-03	3-1/4" Acme Retaining Ring for Screen
<b>Acme Gaskets</b>	MEW4	1-1/4" Acme Flat Gasket for Motor Fuel
	MEW3	1-1/4" Acme Flat Gasket
	MEW2	1-3/4" Acme Flat Gasket
	MEW5	2-1/4" Acme Flat Gasket
	MEW6	3-1/4" Acme Flat Gasket
<b>Back Check Valves</b>	ME868-16-05	Universal 1-1/4" - 2" Replacement Excelsa-Flange O-Ring
	ME870-6-06	3/4" Back Check Valves O-ring
	ME870-10-06	1-1/4" Back Check Valves O-ring
	ME870-16-06	2" Back Check Valves O-ring
	ME870-24-06	3" Back Check Valves O-ring
<b>Combination Valves</b>	ME815K	Bonnet Assembly for ME830
<b>Container Fill Valves</b>	ME601-902	Replacement 1-3/4" F. Acme Cap w/ Lanyard - Plastic
	ME601-6SRK	Complete Seal Repair Kit For ME601-6 Fill Valve
	ME601-10SRK	Complete Seal Repair Kit For ME601-10 Fill Valve
	ME601-10-108	Replacement Nylon Body Gasket For ME601-10
	ME601-10-901	Replacement Molded Valve Poppet For ME601-10
<b>ESV Emergency Shutoff Valves</b>	ME980-903K	1-1/4"-3" ESV Cable Latch Assembly
	ME980-904K	1-1/4"-3" ESV Pneumatic Latch Assembly
	ME980-905	Universal Thermally Activated Remote Cable Release Mechanism
	ME980-905-25	Universal Thermally Activated Remote Cable Release Mechanism w/ 25' Cable
	ME980-905-50	Universal Thermally Activated Remote Cable Release Mechanism w/ 50' Cable
	ME980-906-25	Universal Remote Release Cable - 25'
	ME980-906-50	Universal Remote Release Cable - 50'
	ME980-907	Remote Thermally Activated Elbow 1/4" cc Inlet - For Pneumatic Latch Systems
	ME980HRK	1-1/4"-3" ESV Replacement Handle Assy.
	ME980-6K	3/4" - 1" ESV Complete Repair Kit
	ME980-6SRK	3/4" - 1" ESV Valve Seal Repair Kit
	ME980-10-901	1-1/4" Replacement (ESV) & Back Check Valve Clapper Assy.
	ME980-16-901	2" Replacement (ESV) & Back Check Valve Clapper Assy.
	ME980-24-901	3" Replacement (ESV) & Back Check Valve Clapper Assy.
	ME980-10K	1-1/4" (ESV) Complete Valve Repair Kit
	ME980-16K	2" (ESV) Complete Valve Repair Kit
	ME980-24K	3" (ESV) Complete Valve Repair Kit
	ME980-10SRK	1-1/4" (ESV) Seal Repair Kit
	ME980-16SRK	2" (ESV) Seal Repair Kit
	ME980-24SRK	3" (ESV) Seal Repair Kit
<b>Excelsator Internal Valves 1-1/4" Threaded</b>	ME990-10-VRK	Excelsator 1-1/4" Internal Valve Rebuild Kit
	ME990-10-SRK	Excelsator 1-1/4" Internal Valve Seal Repair Kit
	ME990-10-PRK	Excelsator 1-1/4" Internal Valve Stem Packing Repair Kit
	ME990-10-PGA	Excelsator 1-1/4" Internal Valve Stem Packing Gland Assy.
	ME990-10-106-35	Excelsator 1-1/4" Internal Valve Excess Flow Spring - 35 GPM (Blue)
	ME990-10-106-55	Excelsator 1-1/4" Internal Valve Excess Flow Spring - 55 GPM (Green)
	ME990-10-106-85	Excelsator 1-1/4" Internal Valve Excess Flow Spring - 85 GPM (Orange)
	ME990-10-129	Excelsator 1-1/4" Internal Valve Manual Lever
	MEP147-01	1-1/4" Plated Steel Cable Connector Ring For 1-1/4"-3" Internal Valves



	Part No.	Description
<b>Exceleator Internal Valves 2" &amp; 3" Threaded and Threaded Tee Body</b>	ME990-140	Exceleator 2"-3" Manual Operating Lever - Standard
	ME990-160	Universal Internal Valve Fusible Link 212 Degrees
	ME990-16-VRK	Exceleator 2" Internal Valve Rebuild Kit
	ME990-16-SRK	Exceleator 2" Internal Valve Seal Repair Kit
	ME990-24-VRK	Exceleator 3", 3"DF, 3"DFM Internal Valve Rebuild Kit
	ME990-24-SRK	Exceleator 3", 3"DF, 3"DFM Internal Valve Seal Repair Kit
	ME990-PRK	Exceleator 2" & 3" Internal Valve Stem Packing Repair Kit
	ME990-PGA	Exceleator 2" & 3" Internal Valve Stem Packing Gland Assy.
	ME990-16-106-110	Exceleator 2" Internal Valve Excess Flow Spring - 110GPM (Yellow)
	ME990-16-106-160	Exceleator 2" Internal Valve Excess Flow Spring - 160GPM (Green)
	ME990-16-106-260	Exceleator 2" Internal Valve Excess Flow Spring - 260GPM (Blue)
	ME990-106-175	Exceleator 3" Internal Valve Excess Flow Spring - 175GPM (Purple)
	ME990-106-250	Exceleator 3" Internal Valve Excess Flow Spring - 250GPM (Black)
	ME990-106-300	Exceleator 3" Internal Valve Excess Flow Spring - 300GPM (Green)
	ME990-106-375	Exceleator 3" Internal Valve Excess Flow Spring - 375GPM (Yellow)
	ME990-106-400	Exceleator 3" Internal Valve Excess Flow Spring - 400GPM (Red)
	ME990-106-475	Exceleator 3" Internal Valve Excess Flow Spring - 475GPM (Silver)
	ME990-106-500	Exceleator 3" Internal Valve Excess Flow Spring - 500GPM (White)
	MEP147-01	Cable Connector Ring for 1-1/4"-3" Internal Valves
<b>Exceleator Internal Valves 3" Flanged &amp; Double Flanged Off-Set</b>	ME990-3DF-121	Exceleator 3" Double Flange Self-Guiding Poppet Retaining Nut
	ME990-3DF-122	Exceleator 3" Double Flange Retaining Nut Roll Pin
	ME990-3DF-138	Exceleator 3" Double Flange Screen Mounting Post
	ME990-3DF-144	Exceleator 3" Double Flange Filter Screen Perforated - Stainless Steel
	ME990-3DF-145	Exceleator 3" Double Flange Filter Cap Perforated - Stainless Steel
	ME990-3DF-146	Exceleator 3" Double Flange Screen Mounting Post - Locknut
	ME990-3DF-148	Exceleator 3" Double Flange Stem Guide Bracket
	ME930-244	Exceleator 3" Double Flange Stem Guide Bracket Screw #10-32
	ME990-151	3" Internal Valve Tank Side Mounting Stud 3-1/2" OAL B7
	ME904SK-02	3" Internal Valve Mounting Stud Standard Hex Nut 3/4-10 B8
	ME990-3DF-153	Exceleator 3" Double Flange Internal Valve Inlet Flange Gasket
	ME904S-3F-027	Exceleator 3" Double Flange Outlet/3" Modified Inlet Flange Gasket
	ME990-3DFO-102	Offset Stand-Off 1/2-13UNC-2A x 5/16-24UNF-2A x 1.67" OAL - SS
	ME990-3DFO-103	Offset Gland Plug 1-3/8-12UNF-2A x 1-5/8" HX - SS
<b>Exceleator Internal Valves 4" Flanged</b>	MEP990-4F	Manual Latch For 4" Internal Valves
	ME990-4F-VRK	Exceleator 4" Internal Valve Rebuild Kit
	ME990-4F-SRK	Exceleator 4" Internal Valve Seal Repair Kit
	ME990-4F-PRK	Exceleator 4" Internal Valve Stem Packing Repair Kit
	ME990-4F-PGA	Exceleator 4" Internal Valve Stem Packing Gland Assy.
	ME990-4F-146	Exceleator 4" Internal Valve Filter Screen Retain Bolt - 1/4-28
	ME990-4F-153	Exceleator 4" Internal Valve Inlet Flange Gasket
	ME990-4F-172	Exceleator 4" Internal Valve Outlet Flange Gasket
	ME990-4F-106-375	Exceleator 4" Internal Valve Excess Flow Spring - 375GPM (Cyan)
	ME990-4F-106-500	Exceleator 4" Internal Valve Excess Flow Spring - 500GPM (Black)
	ME990-4F-106-650	Exceleator 4" Internal Valve Excess Flow Spring - 650GPM (Green)
	ME990-4F-106-850	Exceleator 4" Internal Valve Excess Flow Spring - 850GPM (Yellow)
	ME990-4F-106-1250	Exceleator 4" Internal Valve Excess Flow Spring - 1250GPM (Red)
	ME990-4F-106-1500	Exceleator 4" Internal Valve Excess Flow Spring - 1500GPM (White)



	Part No.	Description
<b>Exceleator Internal Valves 4" Flanged</b>	ME990-4F-144	Exceleator 4" Internal Valve Filter Screen Perforated - Stainless Steel
	ME990-4F-145	Exceleator 4" Internal Valve Filter Cap Perforated - Stainless Steel
	ME990-4F-162	Exceleator 4" Internal Valve Filter Screen/Cap #5 MESH
	ME990-4F-151	4" Internal Valve Mounting Stud 6-3/4" OAL B7 Xylan Coated
	ME990-152	3" Modified & 4" Internal Valve Mounting Stud Heavy Hex Nut 3/4-10 B8
	ME990-3F-24-150	3 & 4" Internal Valve Mounting Sleeve/Bushing
<b>Exceleator High Flow Railcar ESV</b>	ME983-SRK	Exceleator High Flow Railcar ESV - Seal Repair Kit - Nitrile
	ME983-VRK	Exceleator High Flow Railcar ESV - Complete Valve Repair Kit - Nitrile
	ME983-119-150	Exceleator High Flow Railcar ESV - Replacement Excess Flow Spring 150 GPM
	ME983-119-250	Exceleator High Flow Railcar ESV - Replacement Excess Flow Spring 250 GPM
	ME983-119-500	Exceleator High Flow Railcar ESV - Replacement Excess Flow Spring 500 GPM
	ME983-121	Exceleator High Flow Railcar ESV - Replacement Quick Disconnect Nipple
<b>Exceleator-Flange Series Excess Flow Valves</b>	MEP183-102	Replacement Torque Posts
<b>External Pressure Relief Valves</b>	MEPS-UT12X	Replacement Poly Cap for MEVS-PVE431 & 431B
	MEPS-431	1" FNPT Pipeaway Adapter for MEVS-PVE431 & 431B
	MEV250-015	MEV250 Series Stainless Steel Weep Hole Deflector
	MEV250-013	Relief Valve Dust Cap with Lanyard
<b>Fill Check Adapters</b>	ME571-06	Replacement Plastic Spacer Ring For ME571
	ME571-2-03	Replacement Nose Gasket For ME571
<b>Flex-Vent Regulator Vent Kit</b>	ME900-6	90° Regulator Vent Assembly w/ Filter
	ME960-106	Hose Clamp
	ME960-107	Anchor Screw
<b>Float Gauges (Accu-Max)</b>	MES-1284-21-1	Universal ASME/DOT lift truck float gauge dial screw
	MES-1284-21-2	Junion float gauge head gasket
	ME930-905	ME930 Series 4" DOT Dial—Glow/Black
	ME930C-905	ME930 Series 4" DOT Dial—Silver/Black
	ME940-905	ME940 Series 8" ASME Dial—Glow/Black
	ME940C-905	ME940 Series 8" ASME Dial—Silver/Black
<b>Flow Indicating Check Valve</b>	ME981-901	1-1/4" - 3" Replacement Swing Check Indicator Dial
<b>Fuse Plugs</b>	ME205-013	1/8" MPT Thermal Safety Plug
	ME206-09	3/8 MPT Thermal Safety Plug 212 Deg
<b>Gas Box</b>	ME952-07	ME951 and ME952 Series Dust Cap
<b>Globe &amp; Angle Valves</b>	ME815K	1/2", 3/4" & 1" Angle & Globe Valve Complete Bonnet Assembly
	ME815-10BRK	1-1/4" & 1-1/2" Angle & Globe Valve Complete Bonnet Assembly
	ME815-10SRK	1-1/4" & 1-1/2" Angle & Globe Valve Replacement Seal Repair Kit
	ME815-10/16HRK	1-1/4", 1-1/2" & 2" Angle & Globe Valve Replacement Handle & Retaining Nut
	ME815-16BRK	2" Angle & Globe Valve Complete Bonnet Assembly
	ME815IBC-16BRK	2" Angle & Globe Valve with Integrated Back Check Complete Bonnet Assembly
	ME815P-16BRK	2" Angle & Globe Valve with Pilot Complete Bonnet Assembly
	ME815-16SRK	2" Angle & Globe Valve Replacement Seal Repair Kit
	ME815IBC-16SRK	2" Angle & Globe Valve with Integrated Back Check Replacement Seal Repair Kit
	ME815P-16SRK	2" Angle & Globe Valve with Pilot Replacement Seal Repair Kit
	ME815-24BRK	3" Angle & Globe Valve Replacement Bonnet Assembly
	ME815-24SRK	3" Angle & Globe Valve Replacement Seal Kit
	ME815-24HRK	3" Angle & Globe Valve Replacement Handle Kit
	ME825-3F-BRK	3" Flanged Globe Valve Complete Bonnet Repair Kit
	ME825-3F-SRK	3" Flanged Globe Valve Seal Repair Kit
ME825-4F-BRK	4" Flanged Globe Valve Complete Bonnet Repair Kit	

	Part No.	Description
<b>Globe &amp; Angle Valves</b>	ME825-4F-SRK	4" Flanged Globe Valve Seal Repair Kit
	ME980SK-24	3" & 4"-300LB ESV & Globe Valve Flange Stud Kit
	ME904S-3F-027	3"-300 LB Spiral Ring Flange Gasket-Carbon Steel
	ME904S-4F-027	4"-300 LB Spiral Ring Flange Gasket-Carbon Steel
<b>High Flow Bypass Valves</b>	ME840-6K	3/4" & 1" High Flow Bypass Complete Repair Kit - Less Spring
	ME840-6SRK	3/4" & 1" High Flow Bypass Complete Seal Repair Kit
	ME840-8-108-60	3/4" & 1" High Flow Bypass Valve Replacement Spring 25-60 PSI
	ME840-8-108-150	3/4" & 1" High Flow Bypass Valve Replacement Spring 50-150 PSI
	ME840-8-108-225	3/4" & 1" High Flow Bypass Valve Replacement Spring 100-225 PSI
	ME870-24-06	3/4" & 1" High Flow Bypass Valve Replacement Bonnet O-Ring
	ME840K	1-1/4" - 2" High Flow Bypass Complete Repair Kit - Less Spring
	ME840SRK	1-1/4" - 2" High Flow Bypass Seal Repair Kit
	ME840-16-108-40	1-1/4" - 2" High Flow Bypass Valve Spring 20-40 PSI
	ME840-16-108-70	1-1/4" - 2" High Flow Bypass Valve Spring 41-70 PSI
	ME840-16-108-90	1-1/4" - 2" High Flow Bypass Valve Spring 71-90 PSI
	ME840-16-108-125	1-1/4" - 2" High Flow Bypass Valve Spring 91-125 PSI
	ME840-16-108-150	1-1/4" - 2" High Flow Bypass Valve Spring 126-150 PSI
	ME868-16-05	1-1/4" - 2" Universal 4 Bolt Flange O-Ring
	ME840-16-109	1-1/4" - 2" Universal Bonnet O-Ring
	ME840-16-110	1-1/4" - 2" Universal Spring Guide O-Ring
	ME840-16-104	1-1/4" - 2" Universal Valve Poppet - Stainless Steel
	ME840C-16-104	1-1/4" - 2" Classic Style Valve Poppet - Stainless Steel
	ME840-24K	3" High Flow Bypass Complete Repair Kit - Less Spring
	ME840-24SRK	3" High Flow Bypass Seal Repair Kit
ME840-24-105-100	3" High Flow Bypass Valve Spring 0-100 PSI	
ME840-24-105-200	3" High Flow Bypass Valve Spring 100-200 PSI	
<b>Hose Clamps</b>	ME3162-08-02K	1 Pair 1/2" Hose Clamps & Bolts
	ME3162-12-02K	1 Pair 3/4" Hose Clamps & Bolts
	ME3162-16-02K	1 Pair 1" Hose Clamps & Bolts
	ME3162-20-02K	1 Pair 1-1/4" Hose Clamps & Bolts
	ME3162-24-02K	1 Pair 1-1/2" Hose Clamps & Bolts
	ME3162-32-02K	1 Pair 2" Hose Clamps & Bolts
<b>Hose End Holster</b>	MEP801-03	MEP801 Series Black Urethane Holster Sleeve
	MEP801-04	MEP801 Series Black Urethane Holster Strap
<b>Hose End Swivel</b>	ME850SS-K	Seal Repair Kit
<b>Hose End Valves</b>	ME800-HRK	ME800 and ME800EXT Series Handle Repair Kit
	ME800-LSRK	ME800 and ME800EXT Series Lower Seal Repair Kit
	ME800-SARK	ME800 and ME800EXT Series Stem Assembly Repair Kit
	ME800-USRK	ME800 and ME800EXT Series Upper Seal Repair Kit
<b>Industrial Regulator MEGR-164 Series</b>	MEGR-164-03	Replacement Diaphragm for MEGR-164 Series
<b>Industrial Regulator MEGR-198H Series</b>	MEGR-198H-03	Replacement Diaphragm for MEGR-198H Series
<b>Industrial Regulator MEGR-1133 Series</b>	MEGR-1133H-01/05	2-5PSI Spring For MEGR-1133H Series
<b>Industrial Regulator MEGR-CS1200 Series</b>	MEGR-CS1200-02/25	1/4" Orifice For MEGR-CS1200 Series
	MEGR-CS1200-02/312	5/16" Orifice For MEGR-CS1200 Series
	MEGR-CS1200-02/38	3/8" Orifice For MEGR-CS1200 Series
	MEGR-CS1200-02/50	1/2" Orifice For MEGR-CS1200 Series
	MEGR-CS1200-01/6.5	3.5-6.5"WC Spring For MEGR-CS1200 Series - Red
	MEGR-CS1200-01/14	6-14"WC Spring For MEGR-CS1200 Series - Green
	MEGR-CS1200-01/33	12-33"WC Spring For MEGR-CS1200 Series - Orange
	MEGR-CS1200-03	Replacement Diaphragm For MEGR-CS1200 Series





	Part No.	Description
<b>Industrial Regulator MEGR-S1202 Series</b>	MEGR-S1202-02/50	1/2" Orifice For MEGR-S1202 Series
	MEGR-S1202-02/75	3/4" Orifice For MEGR-S1202 Series
	MEGR-S1202-02/100	1" Orifice For MEGR-S1202 Series
	MEGR-S1202-02/1187	1-3/16" Orifice For MEGR-S1202 Series
	MEGR-S1202-01/9	5-9"WC Spring For MEGR-S1202 Series - Black
	MEGR-S1202-01/18	8.5-18"WC Spring For MEGR-S1202 Series - White
	MEGR-S1202-01/30	14-30"WC Spring For MEGR-S1202 Series - Green
	MEGR-S1202-01/2	1-2 PSI Spring For MEGR-S1202 Series - Blue
	MEGR-S1202-01/3.25	1.5-3.25PSI Spring For MEGR-S1202 Series - Orange
	MEGR-S1202-01/5	2-5PSI Spring For MEGR-S1202 Series - Yellow
	MEGR-S1202-03	Replacement Diaphragm For MEGR-S1202 Series
<b>Industrial Regulator MEGR-1289 Series</b>	MEGR-1289-8-01/4.5	1-4.5 PSI Spring For MEGR-1289 1" Series - Pink
	MEGR-1289-8-01/15	4-15 PSI Spring For MEGR-1289 1" Series - Red
	MEGR-1289-8-01/20	10-20 PSI Spring For MEGR-1289 1" Series - Silver
	MEGR-1289-8-01/50	15-50 PSI Spring For MEGR-1289 1" Series - Green
	MEGR-1289-8-03	Replacement Diaphragm For MEGR-1289 1" Series
	MEGR-1289-16-01/18	7-18"WC Spring For MEGR-1289 2" Series - Blue
	MEGR-1289-16-01/2.25	.5-2.25PSI Spring For MEGR-1289 2" Series - Grey
	MEGR-1289-16-01/7	1.75-7 PSI Spring For MEGR-1289 2" Series - Green
	MEGR-1289-16-01/10	4-10 PSI Spring For MEGR-1289 2" Series - Red
MEGR-1289-16-03	Replacement Diaphragm For MEGR-1289 2" Series	
<b>Industrial Regulator MEGR-1627 Series</b>	MEGR-1627-01/20	5-20 PSI Spring For MEGR-1627 Series - Yellow
	MEGR-1627-01/40	15-40 PSI Spring For MEGR-1627 Series - Green
	MEGR-1627-01/95	10-95 PSI Spring For MEGR-1627Series - Blue
	MEGR-1627-02/25	1/4" Aluminum Orifice For MEGR-1627 Series
	MEGR-1627-02/38	3/8" Aluminum Orifice For MEGR-1627 Series
	MEGR-1627-02/50	1/2" Alum Orifice For MEGR-1627 Series
	MEGR-1627-04	Vent Assembly For MEGR-1627 Series
	MEGR-1627-05	Adjusting Screw Cover - Plastic For MEGR-1627 Series
	MEGR-1627-03	Replacement Diaphragm For MEGR-1627 Series
MEGR-1627-03R	Replacement Diaphragm For MEGR-1627R Series	
<b>Industrial Regulator MEGR-1630 Series</b>	MEGR-1630-01/10	3-10 PSI Spring For MEGR-1630 Series
	MEGR-1630-01/20	8-20 PSI Spring For MEGR-1630 Series
	MEGR-1630-01/30	17-30 PSI Spring For MEGR-1630 Series
	MEGR-1630-02/25	1/4" Orifice For MEGR-1630 Series
	MEGR-1630-02/38	3/8" Orifice For MEGR-1630 Series
	MEGR-1630-02/50	1/2" Orifice For MEGR-1630 Series
	MEGR-1630-04	Vent Assembly For MEGR-1630 Series
	MEGR-1630-03	Replacement Diaphragm For MEGR-1630 Series
<b>Internal Valve Actuators</b>	ME205-013	212° F. Thermal Safety Plug for ME205, ME205R, ME225, ME226, ME227, ME228, ME552, ME710
	ME206-09	212° F. Thermal Safety Plug for ME206, ME207, ME207SF, ME208SF
<b>Keys</b>	ME530-03	ME530, ME531, ME532 and ME533 Series Key
	ME578-02	ME578 and ME600 Series Key
<b>Liquid Withdrawal Adapters &amp; Tank Valves</b>	ME461	1-5/8" UNS Female Thread Replacement Cap and Gasket for ME460 & ME462
	ME461S	1-5/8" UNS Female Thread Replacement Cap and Gasket for ME462S
	ME461SS	1-5/8" UNS Female Thread Replacement Cap and Gasket for ME462SS
	ME458-03	ME458, ME460 and ME462 Series Nylon Gasket
	ME458-04	ME458 Series Nitrile O-ring
<b>Low Pressure Test Kits</b>	ME50-H	ME50P-2 and ME60P-2 Hose and Bell Assembly
	ME60P-2-01	ME60P-2 Screw Driver to Adjust Gauge











	Part No.	Description
<b>Manifold (Relief Valves)</b>	ME904S-3F-027	Replacement Excelerator 3" Double Flange Outlet/3" Modified Inlet Flange Gasket
	ME904S-4F-027	Replacement 4" Modified Flange Flexatalic Gasket For ME904S-4F
	ME904SK	Quad-Port, 3/4-10UNC Mounting Stud Kit W/Nuts - 8Studs
	ME904SK-02	Replacement 3" Internal Valve Mounting Stud Standard Hex Nut 3/4-10 B8
	MEV125-109	Replacement Plastic Rain Cap for MEV125 Series Relief Valves - Black
<b>Moto-Seal</b>	ME795-3-02	Replacement Tip Seal
<b>Multipurpose Withdrawal Valves</b>	ME670-BRK	Replacement Bonnet Assembly for ME670, ME671, ME672 & ME673 Series Valves
	ME670-SRK	Replacement Seal Repair Kit for ME670, ME671, ME672 & ME673 Series Valves
	ME670-USRK	Replacement Upper Stem Seal Repair Kit for ME670, ME671, ME672 & ME673 Series Valves
	ME670-HRK	Replacement Handle Repair Kit for ME670, ME671, ME672 & ME673 Series Valves
	ME671IBC-BRK	Replacement Bonnet Assembly for ME671IBC Series Valves
	ME671IBC-SRK	Replacement Seal Repair Kit for ME671IBC Series Valves
	ME670-107	Replacement Data Plate for ME670DEX
	ME670-108	Replacement Data Plate for ME670DBC
<b>Multi-Service ASME Container Vapor Valves</b>	ME9101C1BRK	Complete ASME/DOT Valve Replacement Bonnet Assembly w/ Handwheel
	ME9101BRK	Replacement Universal Bonnet Repair Assembly, Less Handwheel - Fits all MEC Service Valves
	ME9101C1-102	ASME/DOT Replacement Service Valve Handwheel - Zinc
	ME9101P5-109	Universal Replacement Handwheel Retaining Screw #10-32
	ME9101P5-114	Universal Replacement Service Valve Bonnet Seal
	MES-1901S	Replacement Handle for MES-PVE3250C, 3250CLG, ALG7T, ADT-7, CLM, 1427B, 1447B & 2035A Series Valves
	ME662-102	Replacement Handle for ME662, 665, MES-3329, 3250BC, 2034CLT, 1447C & 1449 Series Valves
	ME662-901K	Replacement Double Check Fill Valve Kit for ME662
	ME663	Replacement Double Check Vapor Return Vapor Return Valve 3/4" MNPT x 1-1/4" ACME
	MES-2030-100KIT	Fill Valve Repair Kit for MES-PVE2030BC Series Valves
	MES-3329-13LH-KIT	Replacement Bonnet Kit for MES-PVE3329, 3250BC, 2030BC, 2034CLT, 1447C & 1449 Series Valves
<b>O-rings</b>	568-110-01	POL O-ring
	ME220M-02	Motor Fuel Service Valve ME220M O-ring
<b>POL Adapters</b>	ME1002A	Male Hard Nose POL x 1/4" MNPT—Tailpiece Only
	ME1002B	7/8" POL Nut
	ME1002BLH	1-1/8" POL Nut
	ME1600AH	POL Hex Brass Handwheel
	ME1600AR	POL Round Brass Handwheel
	ME1630-02	Plastic Handwheel for 7/8" POL Nut
	ME1630-03	Plastic Handwheel Spring
<b>POL Filler Couplings</b>	ME390WR-1	6" Soft Nose Male Soft Nose POL with O-ring x 1/4" MNPT Stem—Brass
	ME390SWR-1	6" Soft Nose Male Soft Nose POL with O-ring x 1/4" MNPT Stem—Stainless Steel
	ME390-2H	.880 Left Handed Male Thread Extension with Forged Handle
<b>Quick-Acting Toggle Valves</b>	ME791K	Non-Locking Series Bonnet Repair Kit
	ME792K	Locking Series Bonnet Repair Kit
<b>Service Valves</b>	ME9101BRK	MEC Universal Bonnet Replacement Assembly w/o Handwheel
	ME9101C1BRK	MEC 100LB. Service Valve Bonnet Assy. w/ Handwheel
	ME9101P5BRK	MEC Engine Fuel Service Valve Bonnet Assy. w/ Handwheel
	ME9101C1-102	Universal Replacement POL Service Valve Handwheel
	ME9101P5-105	Universal Replacement Motor Fuel Service Valve Handwheel
	ME9101P5-109	Replacement Handwheel Screw #10-32 - Stainless Steel
	ME9101P5-113	Replacement Engine Fuel Service Valve Name Plate
	ME9101P5-114	Universal Replacement Bonnet Seal - Nylon

	Part No.	Description
<b>Sight Flow Swing Check Valves</b>	ME875S-16-05	ME875S-16 Glass
	ME875S-16-06	ME875S-16 Glass Gasket
	ME875S-16-07	ME875S-16 Nitrile O-ring Seal
	ME875S-24-05	ME875S-24 Glass
	ME875S-24-06	ME875S-24 Glass Gasket
	ME875S-24-07	ME875S-24 Nitrile O-ring Seal
<b>Transfer Angle Valves</b>	ME815K	ME449S and ME449EXS Series Bonnet Assembly
<b>TURBO-FLO LE Dry Break Transfer Valve</b>	ME807CRK	ME807-16 Coupling Repair Kit
	ME807HRK	Handle Repair Kit for ME806,807 and 808 Series
	ME807SCRK	ME807S-16 Coupling Repair Kit
	ME807VRK	ME807-16 Valve Repair Kit
<b>TURBO-FLO LE Shutoff Valve</b>	ME807CRK	ME807-16 Coupling Repair Kit
	ME807HRK	Handle Repair Kit for ME806,807 and 808 Series
	ME807SCRK	ME807S-16 Coupling Repair Kit
	ME807VRK	ME807-16 Valve Repair Kit
<b>TURBO-FLO LE Transfer Valve</b>	ME185	3-1/4" Acme Dust Plug with Lanyard
	ME806CRK	ME806-16 Coupling Repair Kit
	ME807HRK	Handle Repair Kit for ME806,807 and 808 Series
	ME806VRK	ME806-16 Valve Repair Kit
<b>Type I Filler Couplings</b>	ME515-3	7" Male Hard Nose POL x 1/4" MNPT Stem—Brass
	ME516-1	6" Male Hard Nose POL x 1/4" MNPT Stem—Brass
	ME516S-01	6" Male Hard Nose POL x 1/4" MNPT Stem—Stainless Steel
	ME516-2H	1-5/16" F. Acme Extension with Forged Handle
<b>Wheel Chock Bracket</b>	ME200B-103	Replacement Rubber Bumper Pad
	ME200EXT	Wheel Chock Block 6" Standoff Extension Kit
<b>Vapor Equalizing Valves</b>	ME663SRK	Replacement Upper Seal Repair Kit for ME663
<b>Vapor Service Valves</b>	ME663SRK	Replacement Upper Seal Repair Kit for ME663
	MES-1901S	MES-3250 Series Valve Shutoff Handwheel .375" ID x 2.00" OD - Aluminum
	MES-3250-8LH-KIT	Bonnet Assy Kit for MES-PVE3250 & 2035A Series
<b>Y-Strainers</b>	ME650-03/20	1/2" & 3/4" Y-Strainers 20 Mesh Screen
	ME650-03	1/2" & 3/4" Y-Strainers 40 Mesh Screen
	ME650-03/80	1/2" & 3/4" Y-Strainers 80 Mesh Screen
	ME652-03/20	1" Y-Strainer 20 Mesh Screen
	ME652-03	1" Y-Strainer 40 Mesh Screen
	ME652-03/80	1" Y-Strainer 80 Mesh Screen
	ME653-02/20	1-1/4" Y-Strainer 20 Mesh Screen
	ME653-02	1-1/4" Y-Strainer 40 Mesh Screen
	ME653-02/80	1-1/4" Y-Strainer 80 Mesh Screen
	ME654-03	1-1/2" Y-Strainer 40 Mesh Screen
	ME655-03/20	2" Y-Strainer 20 Mesh Screen
	ME655-03	2" Y-Strainer 40 Mesh Screen
	ME655-03/80	2" Y-Strainer 80 Mesh Screen
	ME656-03	3" Y-Strainer 40 Mesh Screen
	ME656-03/80	3" Y-Strainer 80 Mesh Screen
	ME656S-3F-109	Replacement 3" Filter Flange Gasket
	ME656S-3F-110	Replacement 3" Filter Flange O-Ring
	ME656S-3F-901	Replacement 3" Flange Y-Strainer Filter
	ME656-4F-108	Replacement 4" Filter Flange Gasket
	ME656-4F-110	Replacement 4" Filter Flange O-Ring
	ME656S-4F-901	Replacement 4" Flange Y-Strainer Filter
	ME980SK-24	3" & 4"-300LB Flange Stud & Nut Kit
	ME904S-3F-027	3"-300 LB Flange Spiral Wound Gasket
	ME904S-4F-027	4"-300 LB Flange Spiral Wound Gasket



# PRODUCTS BY SECTION

	<b>EXCELA-FLO REGULATORS</b>		<b>DOT/ASME CONTAINER VALVES</b>
	<b>TRUCK &amp; PLANT EQUIPMENT</b>		<b>DISPENSING VALVES &amp; ADAPTERS</b>
	<b>ACCU-MAX FLOAT GAUGES</b>		<b>PIGTAILS, HOGTAILS &amp; HOSE ASSEMBLIES</b>
	<b>PRESSURE RELIEF VALVES &amp; MANIFOLDS</b>		<b>FITTINGS &amp; ACCESSORIES</b>
			<b>REPLACEMENT PARTS &amp; REPAIR KITS</b>

## A

Acme Adapters & Reducers  
Acme Caps, Flanges & Plugs  
Acme Spanner Wrenches  
Actuators & Accessories

## B

Back Check Valves  
Back Pressure Regulator Relief Valves  
Breakaway Couplings & Accessories  
Bulkheads  
Bypass Valves

## C

Camping Elbows, Fittings & Tees  
Camping Kits & Adapters  
Carburetion Equipment  
CGA 555 Fittings  
Combination Valves  
Companion Flanges  
Container Fill Valves  
Container Service Valves  
Cylinder Collars  
Cylinder Valve Wrenches (OPD/QCC & POL)

## D

Dielectric Pigtails  
Dielectric Unions  
Dispensing Valves (Quick Acting)  
Double Back Check Valves  
Double Check Filler Valves

## E

Engine Fuel Valves & Accessories  
Emergency Shutoff Valves & Accessories  
Equalizing Valves (Vapor)  
Excess Flow Adapters  
Excess Flow Valves (Container)

## F

Filler Couplings  
Fill Check Adapters (Hose End)  
Ferrules & Menders (Hose)  
Fixed Maximum Liquid Level Gauges  
Flange Unions  
Flare Fittings  
Flex-Vent Regulator Vent Kit  
Float Gauges & Accessories  
Flow Indicating Check Valve  
Four Bolt Flange Union  
Fuse Plugs

## G

Gas Box (Convenience Outlet)  
Globe & Angle Valves  
Grounding Stud

## H

High Pressure Gas Connections  
High Pressure Test Blocks & Accessories  
Hogtails (Copper)  
Hose Barbs  
Hoses (Thermoplastic)  
Hose End Delivery Valves & Accessories  
Hose End Valve Holster  
Hose End Swivel Connectors  
Hose Clamp Couplings  
Hose Reel Control Switch Covers

## I

Internal Valves & Accessories

## L

Leak Detector  
LED Light Strip  
Liquid Transfer Valves & Adapters  
Locking Handwheel Kit  
Low Emission Products  
Low Pressure Test Blocks, Kits & Accessories

## M

Manifolds (Relief Valves)  
Methanol Injector  
Multi-Purpose Valves  
Multi-Service Valves

## N

Needle Valves

## P

Pigtails (Copper)  
Pipeaway Adapters  
Pipe Thread Adapters  
POL Filler Couplings  
POL Fittings  
POL Thread Clean Out Tool  
Pressure Gauges & Accessories  
Pressure Test Kits, Blocks & Accessories

## Q

Quick Connect Filler Coupling  
Quick Disconnect Couplings

## R

Railcar ESV  
Regulators & Accessories  
Relief Valves & Accessories (Hydrostatic)  
Relief Valves & Accessories (Pressure)

## S

Safe-T-Locks  
Seal Gasket Kit  
Serviceman's Friend  
Service Valves  
Sight Flow Valves  
Single Check Remote Fill Valve  
Smart Interlock Technologies & Accessories  
Socket Weld Bodies  
Strainers  
Stainless Steel Braided Pigtails  
Swivel Connectors (Hose End)

## T

Tank Filler Valves  
Tee Check & Block Manifolds  
Thermometers (Container)  
Toggle Valves (Quick Acting)  
Turbo-Flo LE Excelsa-Flange Dry Break Transfer Valves  
Turbo-Flo LE Transfer System & Accessories  
Turbo-Flo LE Shutoff Valve & Accessories  
Type I (QCC) Filler Couplings & Adapters  
Type I (QCC) Connectors

## U

Underground Tank Cluster Manifold  
Underground Tank Cluster Removal Tool  
Utility Bracket

## V

Vapor Couplings  
Vapor Equalizing Valves  
Vent Valves

## W

Wheel Chocks & Accessories  
Withdrawal Valves

## Y

Y-Strainers

# PRODUCTS BY PART NUMBER

568-110-01.....	104
A1132.....	167
A1133.....	167
A1138.....	167
A1139.....	167
A6132.....	167
A6133.....	167
A6138.....	167
A6139.....	167
ME-GMC4 Series.....	155
ME-GMC6.....	155
ME-GMCL4.....	155
ME4H.....	57
ME50ECO-2.....	103
ME50P Series.....	170
ME60-2.....	170
ME602-8.....	140
ME60P Series.....	170
ME100.....	97
ME101.....	97
ME106 Series.....	100
ME108 Series.....	100
ME109 Series.....	100
ME10BTK-04.....	103
ME10BTK-1-01.....	170
ME110 Series.....	97
ME111 Series.....	97
ME112 Series.....	97
ME120 Series.....	97
ME121S Series.....	97
ME130 Series.....	97
ME140.....	97
ME141 Series.....	97
ME150 Series.....	97
ME151 Series.....	97
ME160 Series.....	97
ME178 Series.....	101
ME179 Series.....	101
ME180 Series.....	101
ME181 Series.....	101
ME192.....	98
ME193.....	98
ME200 Series.....	102
ME200PIB.....	58
ME200PIBK.....	58
ME202 Series.....	104
ME204.....	104
ME205 Series.....	86
ME205-013.....	104
ME206.....	86
ME206-09.....	104
ME207.....	86
ME207SF.....	86
ME208SF.....	86
ME209 Series.....	99
ME210.....	98
ME211.....	98
ME212.....	98
ME213 Series.....	98
ME214 Series.....	98
ME215.....	99
ME216.....	99
MEF216 Series.....	165
ME217 Series.....	99
ME217PIB.....	58
ME220 Series.....	142-143
ME220M-02.....	104
ME225.....	85

ME226.....	85
ME227.....	85
ME228.....	85
ME229 Series.....	100-101
ME229-EL.....	143
ME233 Series.....	99
ME239.....	101
ME250 Series.....	98
ME251 Series.....	98
ME252-16 Series.....	98
ME262 Series.....	99
ME270.....	99
ME273 Series.....	99
ME275 Series.....	99
ME277 Series.....	99
ME284.....	157
ME285.....	157
ME286.....	157
ME287.....	157
ME295 Series.....	170
ME296 Series.....	170
ME297 Series.....	170
ME298 Series.....	170
ME299 Series.....	170
ME300.....	157
ME301.....	157
ME302.....	157
ME303.....	157
ME304.....	157
ME305.....	157
ME306.....	166
ME307.....	166
ME308.....	166
ME309-1.....	166
ME312-5MV.....	155
ME318.....	156
ME319.....	156
ME322.....	156
ME345.....	156
ME348.....	156
ME350 Series.....	155
ME351.....	157
ME352.....	157
ME353 Series.....	157
ME354 Series.....	157
ME355 Series.....	157
ME356 Series.....	157
ME357.....	157
ME388.....	145
ME390 Series.....	145
ME392.....	145
ME392P.....	152
ME393 Series.....	144
ME393-1.....	154
ME393-2.....	145
ME393EX Series.....	154
ME394.....	144-145
ME398.....	154
ME399.....	154
ME412.....	160
ME413.....	160
ME414.....	160
ME415.....	160
ME415-01.....	165
ME416.....	160
ME417.....	162
ME418.....	160
ME420.....	160

ME421.....	160
ME422.....	160
ME423.....	161
ME424.....	160
ME425.....	160
ME431 Series.....	100
ME441 Series.....	100-101
ME442 Series.....	99
ME449 Series.....	108
ME450.....	108
ME453.....	109
ME455.....	109
ME458 Series.....	109
ME460.....	108
ME462 Series.....	108
ME474.....	161
ME475 Series.....	161
ME477.....	161
ME480 Series.....	163
ME481.....	161, 163
ME483.....	162
ME484.....	162
ME485.....	162
ME487.....	162
ME488.....	162
ME491.....	162
ME492.....	162
ME493.....	162
ME494.....	162
ME496.....	162
ME497 Series.....	161
ME498 Series.....	98-99
ME502 Series.....	98-99
ME503-16 Series.....	98-99
ME503PIB.....	58
ME508-24 Series.....	98
ME515.....	144
ME516 Series.....	144
ME517 Series.....	152
ME518 Series.....	152
ME519 Series.....	152
ME530 Series.....	158
ME531 Series.....	158
ME532 Series.....	158
ME533.....	158
ME540.....	56
ME551.....	88
ME552.....	88
ME568.....	145
ME569.....	144
ME570.....	60
ME571 Series.....	60
ME572 Series.....	60
ME574 Series.....	60
ME578 Series.....	60
ME600 Series.....	132
ME601 Series.....	133
ME611 Series.....	99
ME612 Series.....	99
ME614 Series.....	99
ME635 Series.....	97
ME646 Series.....	97
ME650S Series.....	94
ME662.....	135
ME663.....	133
ME664.....	133
ME665.....	135
ME670 Series.....	131

# PRODUCTS BY PART NUMBER

ME671D Series.....	131
ME672D.....	131
ME673 Series.....	132
ME690 Series.....	163
ME707.....	85
ME708.....	85
ME709.....	85
ME709.....	143
ME710.....	86
ME790.....	142
ME790L.....	143
ME791 Series.....	146
ME792 Series.....	146
ME796.....	144
ME800 Series.....	55
ME806-16 Series.....	41
ME807-16 Series.....	40
ME807PIB.....	58
ME808-16 Series.....	39
ME808PIB.....	58
ME810 Series.....	59
ME813 Series.....	44-46
ME815 Series.....	45
ME815-16LHK.....	49
ME815IBC-16.....	47
ME815P-16.....	47
ME818 Series.....	44-46
ME819 Series.....	44-46
ME820 Series.....	59
ME822 Series.....	44-46
ME823 Series.....	44-46
ME824IBC-16.....	47
ME824P-16.....	47
ME825 Series.....	45
ME825-3F.....	50
ME825-4F.....	50
ME825IBC-16.....	47
ME825P-16.....	47
ME825P-16-4 Series.....	49
ME828 Series.....	47
ME830.....	109
ME831 Series.....	105
ME832.....	105
ME833.....	105
ME834.....	105
ME840 Series.....	52-54
ME841 Series.....	52-53
ME842 Series.....	52
ME843 Series.....	52
ME850SS Series.....	57
ME860S Series.....	96
ME868 Series.....	42
ME868PIB.....	58
ME869 Series.....	67
ME870 Series.....	66
ME870-10-1.....	95
ME870-16-01.....	95
ME870-6-1.....	95
ME870SW-16.....	65
ME873S Series.....	64
ME875S-16.....	93
ME880 Series.....	63
ME882S Series.....	63
ME883S Series.....	62
ME890PIB.....	58
ME902S Series.....	121
ME903S-16 Series.....	120-121
ME904S-16 Series.....	121-122

ME930 Series.....	115-116
ME931.....	115
ME932.....	115
ME940 Series.....	115
ME940C Series.....	115
ME940WG Series.....	116
ME951 Series.....	153
ME952 Series.....	153
ME960 Series.....	171
ME970P.....	157
ME980 Series.....	89
ME980-905.....	87
ME980-906.....	87
ME980C Series.....	89
ME980SAR-4DFM.....	90
ME980SAR-6DFM.....	90
ME981 Series.....	92
ME982 Series.....	92
ME983-16.....	91
ME990-10 Series.....	69
ME990-16 Series.....	71
ME990-4F Series.....	81
ME990S-2DFM Series.....	75
ME990S-2F-16 Series.....	75
ME990S-3DF.....	79
ME990S-3DFM Series.....	79
ME990S-3DFO Series.....	80
ME990S-3F Series.....	79
ME990SAR-4DFM Series.....	82
ME990SAR-6DFM Series.....	82
ME991-10 Series.....	68
ME991-16 Series.....	73
ME991-24 Series.....	73
ME992-10 Series.....	70
ME992-16 Series.....	72
ME992-24 Series.....	72
ME992S-2F Series.....	78
ME992S-3F Series.....	78
ME993S Series.....	76
ME994S-2F Series.....	74
ME994S-3F Series.....	77
ME1629.....	156
ME1638.....	156
ME1641 Series.....	156
ME1645.....	166
ME1645-78N.....	166
ME1650 Series.....	166
ME1651.....	166
ME1653 Series.....	156
ME1654 Series.....	156
ME1655 Series.....	156
ME1656 Series.....	156
ME1657.....	156
ME1660 Series.....	147
ME1661 Series.....	147
ME1662 Series.....	147
ME1663 Series.....	147
ME1664 Series.....	147
ME1665 Series.....	147
ME1669 Series.....	147-148
ME1679 Series.....	147
ME1680 Series.....	147
ME1680-12B Series.....	148
ME1683.....	156
ME1684.....	156
ME1689 Series.....	147
ME1689.....	166
ME1689-5B90.....	148

ME1689-6B90.....	148
ME1690 Series.....	156
ME1691 Series.....	157
ME1692.....	156
ME1695 Series.....	165
ME1699.....	157
ME1700 Series.....	159
ME1701 Series.....	159
ME1702 Series.....	159
ME1704B.....	159
ME1705A.....	159
ME2132.....	165
ME3121.....	165
ME3162 Series.....	95
ME4231.....	167
ME4232.....	167
ME4233.....	167
ME4252.....	167
ME4253.....	167
ME4254.....	167
ME4273.....	167
ME4274.....	167
ME4293.....	167
ME4333.....	167
ME4335.....	167
ME4355.....	167
ME4357.....	167
ME4377.....	167
ME4631.....	167
ME4632.....	167
ME4633.....	167
ME4652.....	167
ME4653.....	167
ME4654.....	167
ME4835.....	167
ME4855.....	167
ME4857.....	167
ME5231.....	167
ME5232.....	167
ME5233.....	167
ME5253.....	167
ME5274.....	167
ME5334.....	167
ME5335.....	167
ME5336.....	167
ME5355.....	167
ME5357.....	167
ME5377.....	167
ME5632.....	167
ME5633.....	167
ME5653.....	167
ME5835.....	167
ME5930 Series.....	156
ME5931 Series.....	156
ME7323.....	168
ME7324.....	168
ME7325.....	168
ME7326.....	168
ME7327.....	168
ME7329.....	168
ME7330.....	168
ME7331.....	168
ME7332.....	168
ME7333.....	168
ME8346.....	143
ME9101C Series.....	134, 140
MEF41-6.....	165
MEF42 Series.....	164

# PRODUCTS BY PART NUMBER

MEF44 Series.....	165
MEF46 Series.....	164
MEF48 Series.....	164
MEF49 Series.....	165
MEF54 Series.....	164
MEF55 Series.....	165
MEGR-1HSRL Series.....	33
MEGR-100C.....	16
MEGR-130 Series.....	28
MEGR-164 Series.....	30
MEGR-175CS Series.....	23
MEGR-198H Series.....	31
MEGR-199 Series.....	36
MEGR-218.....	26
MEGR-230 Series.....	26
MEGR-231.....	26
MEGR-253 Series.....	24
MEGR-291 Series.....	25
MEGR-295 Series.....	25
MEGR-298 Series.....	25
MEGR-300 Series.....	22
MEGR-350 Series.....	28
MEGR-351.....	28
MEGR-360.....	28
MEGR-1122H Series.....	12-15
MEGR-11301F.....	31
MEGR-1133 Series.....	34
MEGR-1222-BAF.....	15
MEGR-1222HT.....	14
MEGR-1232 Series.....	20
MEGR-1232E Series.....	21
MEGR-1232T Series.....	19
MEGR-1252-BAF.....	15
MEGR-1289H Series.....	35
MEGR-1290H Series.....	35
MEGR-1622 Series.....	15
MEGR-1622E Series.....	17
MEGR-1622H Series.....	13
MEGR-1622HT Series.....	14
MEGR-1627 Series.....	32
MEGR-1630-104/78.....	32
MEGR-1632 Series.....	20
MEGR-1632E Series.....	21
MEGR-1632T Series.....	19
MEGR-1642-DFE.....	16
MEGR-1652 Series.....	15
MEGR-1652E-DFH.....	17
MEGR-1652H-JGK.....	14
MEGR-1912 Series.....	27
MEGR-6120 Series.....	29
MEGR-6121 Series.....	29
MEGR-CS1200 Series.....	33
MEGR-S1202 Series.....	33
MEH25 Series.....	130
MEH50 Series.....	130
MEH75 Series.....	130
MEH225 Series.....	130
MEH501 Series.....	130
MEH502.....	128
MEH503.....	128
MEJ2.5GB.....	103
MEJ400 Series.....	106
MEJ402S-120.....	106
MEJ410 Series.....	106
MEJ501.....	103
MEJ502.....	103
MEJ503.....	103
MEJ504.....	103
MEJ415 Series.....	109
MEJ500.....	103
MEJ505.....	103
MEJ510.....	103
MEJ511.....	103
MEJ512.....	103
MEJ513.....	103
MEJ516.....	103
MEJ520.....	103
MEJ524.....	103
MEJ526.....	103
MEJ542.....	103
MEJ552.....	103
MEJ580.....	103
MEJ595.....	170
MEJ600.....	169
MEJ600-02.....	103
MEJ601 Series.....	169
MEJ602.....	170
MEJ602H.....	106, 130
MEJ603HP.....	170
MEJ603LP.....	170
MEJ603HP-01.....	103
MEJ603LP-01.....	103
MEJ606.....	106
MEJ607-02.....	170
MEJ608 Series.....	170
MEJ610 Series.....	170
MEJ700.....	103
MEJ701.....	103
MEJ702.....	103
MEJ703.....	103
ME-LD Series.....	168
ME-NS4 Series.....	164
MEP2 Series.....	165
MEP082.....	102
MEP100.....	158
MEP104-24.....	95
MEP104-95.....	171
MEP105.....	42
MEP121.....	145
MEP122.....	145
MEP126.....	141
MEP147.....	101
MEP148.....	101
MEP456A.....	159
MEP503.....	99
MEP650.....	87
MEP651.....	87
MEP700.....	146
MEP801.....	56, 58
MEP802 Series.....	56, 58
MEP803PCK Series.....	58
MEP804 Series.....	56, 58
MEP840 Series.....	52
MEP841 Series.....	52
MEP990-24.....	87
MEP990-4DFM.....	90
MEP990-4F.....	87
MEP990-6DFM.....	90
MEP995S Series.....	51
MEP996S Series.....	51
MEP-GMC1.....	105
MEP-RDC1.....	105
MER401 Series.....	149
MER403 Series.....	149
MER404 Series.....	149
MER405 Series.....	149
MER406AR Series.....	149
MER407 Series.....	149
MER408 Series.....	149
MER409 Series.....	149
MER410 Series.....	149
MER412 Series.....	149
MER413 Series.....	149
MER414 Series.....	149
MER421 Series.....	149
MER422 Series.....	149
MER423 Series.....	149
MER425 Series.....	149
MER425H Series.....	150
MER425HSS Series.....	150
MER425SS Series.....	150
MER426 Series.....	149
MER426H Series.....	150
MER427 Series.....	149
MER428 Series.....	149
MER429 Series.....	149
MER432 Series.....	170
MER434 Series.....	149
MER470.....	151
MER471.....	151
MER472.....	151
MER473.....	151
MER610 Series.....	148
MER611 Series.....	148
MER613 Series.....	148
ME-RVSDC-4.....	155
MESFF33.....	165
MES-FG1280 Series.....	113
MES-FG1281 Series.....	114
MES-FG1284-001U.....	110
MES-FG2184-001U.....	110
MES-FG2281 Series.....	112
MES-FG2284-001U.....	110
MES-FG3981 Series.....	111
MES-PVE2030BC Series.....	138
MES-PVE2035AT Series.....	139
MES-PVE2098 Series.....	141
MES-PVE3250 Series.....	136-137
MET443.....	143
MET444.....	143
MET445.....	143
ME-T9-444.....	159
METL051.....	170
METL052.....	170
ME-US4 Series.....	164
MEV25 Series.....	123
MEV50 Series.....	123
MEV75 Series.....	123
MEV75FIR.....	125
MEV125 Series.....	124
MEV200FIR Series.....	126
MEV200SIR Series.....	129
MEV250 Series.....	124
MEV300FIR Series.....	126
MEV300FIR-3F Series.....	127
MEVS-PVE431 Series.....	123
MEVS-PVE445 Series.....	125
MEVS-UVE433 Series.....	128
MEVS-UVE443 Series.....	128
MEVS-UVE453 Series.....	128
MEW2.....	104
MEW3.....	104
MEW4.....	104
MEW5.....	104
MEW6.....	104

# WARRENTY INFORMATION

## WARNING

Marshall Excelsior's products are mechanical devices made of materials such as rubber and metal, and are subject to wear, the effects of contaminants, corrosion, and aging, and these devices will eventually become inoperative. **Regular inspection and maintenance is essential.** Marshall Excelsior's products have a long record of quality and service, and therefore LP-Gas dealers may forget hazards that can arise from using aging devices that have outlived their safe service life. The safe service life of these products will be affected by the environment and the conditions of their use. The LP-Gas dealer knows better than anyone what this environment and the conditions of use are.

There are developing trends in state legislation and proposed national legislation making the owner of products responsible for replacing products before they outlive their safe service life. LP-Gas dealers should be aware of such legislation as it affects them.

All Marshall Excelsior products must be installed, inspected and maintained by a trained and experienced professional adhering to all installation instructions, product and safety warnings, local, state, and federal regulations, codes and standards and any other standards set by, but not limited to, NFPA, DOT or ANSI.

**LP-Gas is a highly explosive and flammable gas that should never be vented near a possible ignition source.**

## LIMITED WARRANTY

THIS WARRANTY for Marshall Excelsior manufactured products is provided by Marshall Excelsior, Inc., 1506 George Brown Drive, Marshall, MI 49068. Marshall Excelsior, unless otherwise specified in writing, warrants to the original buyer that for a period of five (5) years from the date of manufacture its products and repair kits will be free from defects in material and workmanship under normal service and use. This warranty covers manufacturing defects only, and does not cover defects and product non-compliance due to, misuse, alteration, neglect, accident, fire, or other external causes, alterations, or repairs. This limited warranty also does not cover normal wear and tear. During this warranty period, if a defect arises in the product, and you follow the instructions for returning the product, Marshall Excelsior will, at its option, to the extent permitted by law, either (i) repair the product using either new or refurbished parts, (ii) replace the product with a new or refurbished product that is equivalent to the product that is to be replaced, or (iii) refund to you all or part of the purchase price of the product. This limited warranty applies to the extent permitted by law, to any repair, replacement part or replacement device for the remainder of the original warranty period or for ninety (90) days whichever period is longer. All replaced parts and products for which a refund is given shall become the property of Marshall Excelsior. This is the only warranty or representation made by Marshall Excelsior, and the sole basis for liability respecting quality, performance, defects, repair, delivery, and replacement of products and repair kits. The foregoing shall constitute Marshall Excelsior's sole liability.

Marshall Excelsior does not warrant any product or part that has been altered, accidentally damaged, disassembled, modified, misused, neglected, not properly maintained or installed, or not kept in continuous

service after installation. Marshall Excelsior does not warrant cosmetic issues including but not limited to dents, scratches, product discoloration, color fading or any other imperfection that does not affect the functionality of the product. Marshall Excelsior does not warrant any product or part not installed according to Marshall Excelsior's installation instructions or installed in violation of any regulation or warning by state, local, or federal regulators, or in violation of any standard or code set by, but not limited to, NFPA, DOT or ANSI requirements. The foregoing shall constitute Marshall Excelsior's sole liability to distributors, vendees and end users.

## LIMITATIONS

TO THE EXTENT PERMITTED BY LAW, THE WARRANTY AND REMEDIES SET FORTH ABOVE ARE EXCLUSIVE AND IN LIEU OF ALL OTHER WARRANTIES AND REMEDIES, AND MARSHALL EXCELSIOR SPECIFICALLY DISCLAIMS ALL STATUTORY OR IMPLIED WARRANTIES, INCLUDING, BUT NOT LIMITED TO, WARRANTIES OF MERCHANTABILITY, FITNESS FOR A PARTICULAR PURPOSE AND AGAINST HIDDEN OR LATENT DEFECTS. IF MARSHALL EXCELSIOR CANNOT LAWFULLY DISCLAIM STATUTORY OR IMPLIED WARRANTIES, THEN TO THE EXTENT PERMITTED BY LAW, ALL SUCH WARRANTIES SHALL BE LIMITED IN DURATION TO THE DURATION OF THIS EXPRESS LIMITED WARRANTY AND TO REPAIR OR REPLACEMENT AND SERVICE.

MARSHALL EXCELSIOR IS NOT RESPONSIBLE FOR DIRECT, SPECIAL, INCIDENTAL OR CONSEQUENTIAL DAMAGES RESULTING FROM ANY BREACH OF WARRANTY OR UNDER ANY OTHER LEGAL THEORY.

MARSHALL EXCELSIOR'S LIABILITY (EXCEPT AS TO TITLE) ARISING OUT OF THE SALE, USE OR OPERATION OF PRODUCTS OR REPAIR KITS, WHETHER ON CLAIMS FOR BREACH OF WARRANTY, CONTRACT, NEGLIGENCE OR OTHERWISE (INCLUDING CLAIMS OF CONSEQUENTIAL OR INCIDENTAL DAMAGES) SHALL NOT IN ANY EVENT EXCEED THE COST OF FURNISHING OR REPLACEMENT OF THE DEFECTIVE PRODUCT OR REPAIR KIT.

## WARRANTY CLAIMS AND NOTICE

Warranty claims shall be made in writing to Marshall Excelsior's Home Office at 1506 George Brown Drive, Marshall, Michigan 49068 by the distributor, vendee or end user within twenty (20) days of discovery of the defect and the product must be postmarked and shipped F.O.B. origin to Marshall Excelsior's Home Office within thirty (30) days of the discovery of the defect. Marshall Excelsior will not accept any products or repair kits that does not have a Return Material Authorization (RMA) number from the Home Office in Marshall, Michigan. After Marshall Excelsior has inspected the product and deemed the product to be defective, at its discretion, Marshall Excelsior will repair, replace or refund the purchase price of the defective product or repair kit. If the buyer does not comply with the above stated requirements the buyer will waive unconditionally and absolutely any and all claims arising out of the alleged defect.





# WARRANTY INFORMATION

## COMPLIANCE

Marshall Excelsior manufactures all of our products to the highest industry standards. All of our products meet or exceed the requirements of the Compressed Gas Association (CGA), the National Fire Protection Association (NFPA), American National Standards Institute (ANSI), American Society of Mechanical Engineers (ASME) or Underwriters Laboratories, Inc. (UL) where indicated.

## PRODUCT CHANGES

Marshall Excelsior reserves the right to change product specifications at any time. We are constantly evaluating our products and incorporating engineering advances to ensure our products perform and comply with changes in market conditions, government mandates, and code changes. Marshall Excelsior shall not be required to modify any equipment already sold or in service.

## FILTERS

Marshall Excelsior develops products to be used in a debris, dirt and contamination free system. Installing an in-line filter may be necessary in a system that contains unclean product or when the system contains debris, dirt, scale, rust or other contaminants.

## PRODUCT AGE

Marshall Excelsior products are mechanical devices that are subject to wear, contaminants, corrosion, and aging of components made of materials such as rubber and metal. Over time these devices will eventually become inoperative. The safe service life of these products will reflect the environment and conditions of use that they are subjected to. **Regular inspection and maintenance is essential.** Marshall Excelsior products have a long record of quality and service, so LP-Gas dealers may forget hazards that can arise from using aging devices that have outlived their safe service life. The length of a device's life is determined by the environment in which it is used, and the LP-Gas dealer knows better than anyone about this environment.

There are developing trends in state legislation and proposed national legislation making the owner of products responsible for replacing products before they outlive their safe service life. LP-Gas dealers should be aware of such legislation as it affects them.

To determine the product's age, check the product for a date code consisting of a series of letters and numbers.

A = January	B = February	C = March
D = April	E = May	F = June
G = July	H = August	I = September
J = October	K = November	L = December

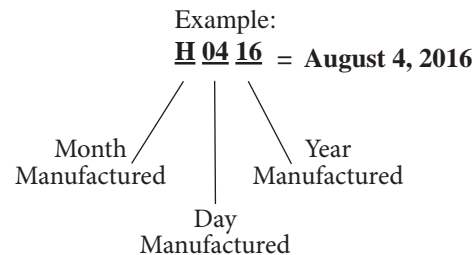

2016



**MARSHALL EXCELSIOR COMPANY**

1506 George Brown Drive  
Marshall, MI 49068

Phone: 269.789.6700 Fax: 269.781.8340

[www.marshallexcelsior.com](http://www.marshallexcelsior.com)

email: [sales@marshallexcelsior.com](mailto:sales@marshallexcelsior.com)