

Bronze Globe Valve for Cryogenic Service Goddard 202X Series Including 206LL, 206GF, 206ULL, 206BLL

Features

- **Top Entry:** This union bonnet valve can be permanently installed in the line and serviced from the top
- **Construction:** Bronze cast body and bonnet
Rugged construction for long life
- **Designed with the unique Kold-Seal™** and high CV. Standard PTFE seat design assures bubble tight seating and high cycle life
- **Sizes:** ¼" through 2" (8mm through 50mm)
- **Ends:** Threaded (FNPT), Sil Braze Tube (SBT), or with stainless steel pipe nipples brazed in.
- **Service:** Liquified and vaporized atmospheric gases, LNG
- **Temperature Rating:** -325°F to 150°F (-196°C to +65°C)
- **Pressure Rating:** (Cold, Non-shock)
202 Series Rated for 400 PSIG
206 Series Rated for 600 PSIG
Sizes 1.5" to 2.0" PED approved per EN10204, 3.1
- **Kold-Seal™ Technology** assures tight seal preventing cryogen gas loss. Non-extended stem for selective cold gas service.

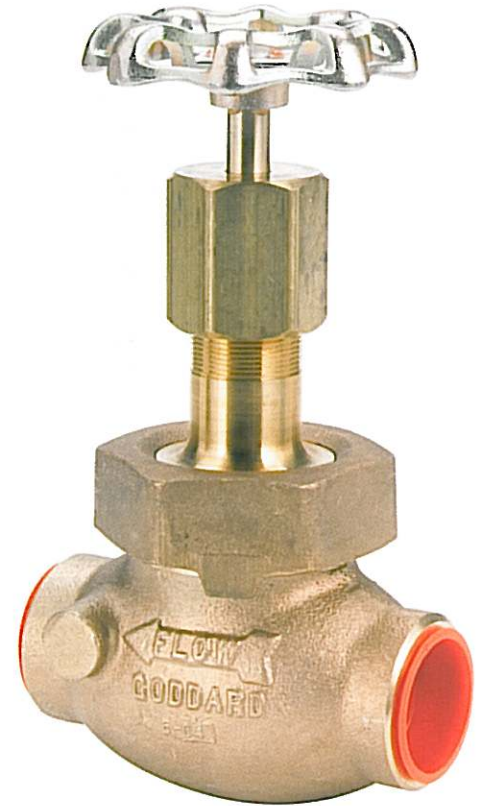

Ordering Information

202X

Bronze Globe Valves

Non-Extended Stem - Conical Seat

400 PSIG Cold Working Pressure

For selective Cold Gas Applications

Threaded End

Part Number	NPT Valve size Inches	Valve Size mm	Ends	Weight Lbs.	Weight Kgs.	Estimated Cv
B-00202X-12T4	1½"	40 mm	Threaded	6.50 Lbs.	3.00 Kgs.	29.00
B-00202X-16T4	2"	50 mm	Threaded	10.50 Lbs.	4.80 Kgs.	50.00

Sil Braze Ends

Part Number	SBT Valve size Inches *	Valve Size mm *	Ends	Weight Lbs.	Weight Kgs.	Estimated Cv
B-00202X-4S4	½"	15 mm	Silver Braze	1.50 Lbs.	0.7 Kgs.	3.90
B-00202X-8S4	1"	25 mm	Silver Braze	3.25 Lbs.	1.50 Kgs.	11.50
B-00202X-12S4	1½"	40 mm	Silver Braze	6.50 Lbs.	3.00 Kgs.	29.00
B-00202X-16S4	2"	50 mm	Silver Braze	10.50 Lbs.	4.80 Kgs.	50.00

* Nominal Size

Bronze Globe Valve for Cryogenic Service

Goddard 202X Series Including 206LL, 206GF, 206ULL, 206BLL

206GF

Bronze Globe Valves

Non-Extended Stem - PFA seat with high temperature, low permeability GRAFOIL® packing and gasket.

600 PSIG Cold Working Pressure, For Selective Cold Gas Applications, High Temperature Service Rating +350°F

Threaded Ends

Part Number	NPT Valve size Inches	Valve Size mm	Ends	Weight Lbs.	Weight Kgs.	Estimated Cv
VB-0206GF-2T6	¼"	8 mm	Threaded	1.25 Lbs.	0.6 Kgs.	1.30
VB-0206GF-4T6	½"	15 mm	Threaded	1.50 Lbs.	0.70 Kgs.	3.90
VB-0206GF-6T6	¾"	20 mm	Threaded	2.50 Lbs.	1.10 Kgs.	7.10
VB-0206GF-8T6	1"	25 mm	Threaded	3.50 Lbs.	1.60 Kgs.	11.50
VB-0206GF-12T6	1½"	40 mm	Threaded	7.00 Lbs.	3.20 Kgs.	29.00
VB-0206GF-16T6	2"	50 mm	Threaded	11.75 Lbs.	5.30 Kgs.	50.00

206LL

Bronze Globe Valves, Non-Extended Stem, Live Loaded Packing, 600 PSIG Cold Working Pressure

For Selective Cold Gas Applications

Threaded Ends

Part Number	NPT Valve size Inches	Valve Size mm	Ends	Weight Lbs.	Weight Kgs.	Estimated Cv
B-0206LL-2T6	¼"	8 mm	¼" NPT	1.25 Lbs.	0.6 Kgs.	1.30
B-0206LL-3T6	⅜"	10 mm	⅜" NPT	1.25 Lbs.	0.6 Kgs.	2.40
B-0206LL-4T6	½"	15 mm	½" NPT	1.75 Lbs.	0.8 Kgs.	3.90
B-0206LL-6T6	¾"	20 mm	¾" NPT	2.5 Lbs.	1.1 Kgs.	7.10
B-0206LL-8T6	1"	25 mm	1" NPT	3.5 Lbs.	1.6 Kgs.	11.50

Sil Brazed Ends

Part Number	SBT Valve size Inches *	Valve Size mm	Ends	Weight Lbs.	Weight Kgs.	Estimated Cv
B-0206LL-4S6	½"	10 mm	Silver Braze	1.25 Lbs.	0.6 Kgs.	3.90
B-0206LL-6S6	¾"	15 mm	Silver Braze	1.75 Lbs.	0.8 Kgs.	7.10
B-0206LL-8S6	1"	20 mm	Silver Braze	2.5 Lbs.	1.1 Kgs.	11.50

* Nominal Size

206ULL

Bronze Globe Valves, Non-Extended Stem, Live Loaded Packing - Union Bonnet,

600 PSIG Cold Working Pressure For Selective Cold Gas Applications

Sil Brazed Ends

Part Number	SBT Valve size Inches	Valve Size mm	Ends	Weight Lbs.	Weight Kgs.	Estimated Cv
B-206ULL-12S6	1½"	40 mm	Silver Braze	7 Lbs.	3.2 Kgs.	29.00
B-206ULL-16S6	2"	50 mm	Silver Braze	11.75 Lbs.	5.3 Kgs.	50.00

206BLL

Bronze Globe Valves, Non-Extended Stem, Live Loaded Packing - Bolted Bonnet,

600 PSIG Cold Working Pressure For Selective Cold Gas Applications

Sil Brazed Ends

Part Number	SBT Valve size Inches	Valve Size mm	Ends	Weight Lbs.	Weight Kgs.	Estimated Cv
B-206BLL-12S6	1½"	40 mm	Silver Braze	7 Lbs.	3.2 Kgs.	29.00

Bronze Globe Valve for Cryogenic Service Goddard 202X Series Including 206LL, 206GF, 206ULL

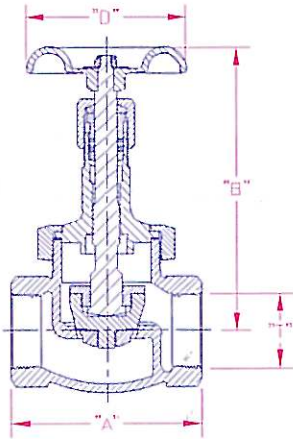

202 Series

202X

Pressure Rating 400 PSIG

Temperature Rating +150°F to -325°F

Non-Extended Valve for Cold Gas Applications

Conical Seat

Dimensional data

All Dimensional Data are in inches.

THREADED ENDS

Size	"A"	"B"	"D"	"T" NPT
1½"	4¾"	8⅝"	4"	1½"
2"	5¾"	9½"	4¾"	2"

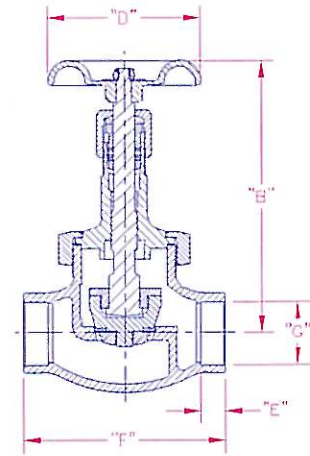

SILVER BRAZED ENDS

Size	"B"	"D"	"E"	"F"	"G"
½"	4⅝"	2"	.38	3¼"	.628/1.630
1"	4⅝"	2"	.44	4¼"	1.129/1.131
1½"	5"	2⅜"	.62	5¼"	1.629/1.632
2"	5¾"	2¾"	.66	6½"	2.129/2.132

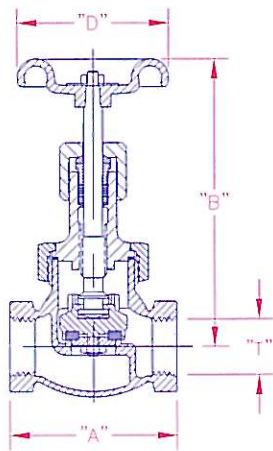

206GF

Pressure Rating 600 PSIG

Temperature Rating +350°F to -325°F

Non-Extended Stem - GRAFOIL® Packing, Gasket and PFA Seat

Dimensional data

All Dimensional Data are in inches.

THREADED ENDS

Size	"A"	"B"	"D"	"T" NPT
¼"	2⅝"	4⅝"	2"	¼"
½"	2⅝"	5"	2⅜"	½"
¾"	3⅜"	5¾"	2¾"	¾"
1"	3¾"	6¾"	3"	1"
1½"	4¾"	8⅝"	4"	1½"
2"	5¾"	9½"	4¾"	2"

Bronze Globe Valve for Cryogenic Service Goddard 202X Series Including 206LL, 206GF, 206ULL

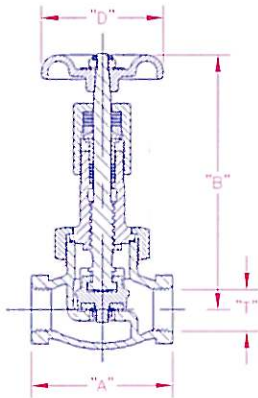

206LL
 Pressure Rating 600 PSIG
 Temperature Rating +150° F to -325° F
 Live Load Packing

Dimensional Data
 All Dimensions are in Inches

THREADED ENDS

Size	"A"	"B"	"D"	"T" NPT
1/4"	2 5/8"	5"	2 3/8"	1/4"
3/8"	2 5/8"	5"	2 3/8"	3/8"
1/2"	2 5/8"	5"	2 3/8"	1/2"
3/4"	3 3/16"	5 3/4"	2 3/4"	3/4"
1"	3 3/4"	5 3/4"	3"	1"

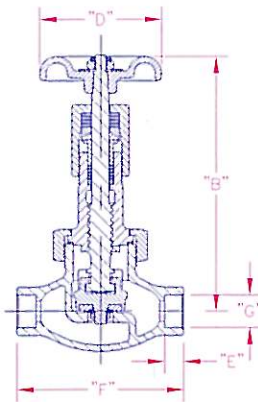

SIL BRAZED ENDS

Size	"B"	"D"	"G"	"E"	"F"
1/4"	5"	2 3/8"	.378/.380	.26	2 3/8"
1/2"	5"	2 3/8"	.628/.630	.38	3 1/4"
3/4"	5 3/4"	2 3/4"	.878/.880	.41	4 1/4"

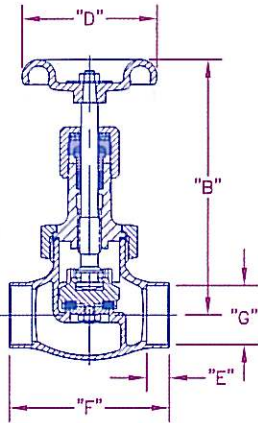

206ULL
 Pressure Rating 600 PSIG
 Temperature Rating +150° F to -325° F
 Live Load Packing - Union Bonnet

Dimensional Data
 All Dimensions are in Inches

THREADED ENDS

Size	"A"	"B"	"D"	"T" NPT
1 1/2"	4 3/4"	8 5/8"	4"	1 1/2"
2"	5 3/4"	11 3/4"	4 3/4"	2"

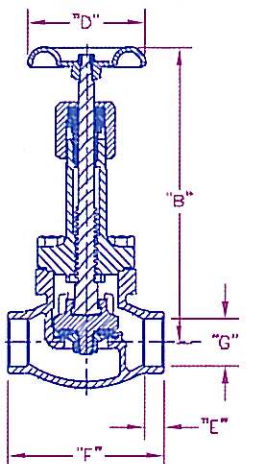

206ULL
 Pressure Rating 600 PSIG
 Temperature Rating +150° F to -325° F
 Live Load Packing - Bolted Bonnet

Dimensional Data
 All Dimensions are in Inches

SIL BRAZED ENDS

Size	"B"	"D"	"G"	"E"	"F"
1 1/2"	8 5/8"	4"	1.625/1.638	.63	5 1/4"